

Coronis Fusion 10MP

User Guide



BARCO

Visibly yours

(This page intentionally left blank.)

Welcome!

Thank you for choosing this CORONIS FUSION 10MP display!



Equipped with proprietary 'SmoothGray' technology for a meticulously rendered grayscale curve, the CORONIS FUSION 10MP display makes subtle details and lesions more noticeable than ever before. Add to this exceptionally high brightness and contrast levels, truly dark blacks and perfect geometry and you begin to understand that supreme grayscale precision has a new meaning.

Thanks to the seamless 30-inch LCD screen, you can easily compare prior and current mammography images without the annoyance of a central bezel. Moreover, it allows you to review X-ray chest images or 40 full-resolution CT or MR images with superb diagnostic precision on a single screen.

The integrated I-Guard sensor makes Quality Assurance an easy job. Combined with the online MediCal QAWeb solution, I-Guard performs intervention-free DICOM calibrations, Quality Assurance tests and remote assessment of your display.

Use the instructions in this guide to install your CORONIS FUSION 10MP display and discover all these interesting features yourself!

Following symbols may be used throughout this guide:

	Warning: Risk of injury to human beings		Caution: Risk of damage to the product
	Important notice or remark		Note
	Hint, tip		Additional information



Read all the safety information starting on page 47 before operating your CORONIS FUSION 10MP display.

(This page intentionally left blank.)

Table of contents

What's in the box.....	7
Parts, controls and connectors	8
Front view	8
Rear view	9
Display installation	10
Removing the covers	10
Unlocking the height mechanism	12
Adjusting the display position	13
Connecting the signal cables.....	14
Connecting the power cables.....	15
Routing the cables.....	15
Re-attaching the covers	16
VESA-mount installation.....	17
First time starting up	19
Daily operation	20
Recommendations for daily operation	20
Key indicator lights	22
Stand-by switching	23
Bringing up the OSD menu.....	24
Navigating through the OSD menus.....	25
Advanced operation	26
OSD menu position.....	26
OSD menu language	26
OSD menu automatic close function	27
Power status indicator light.....	27
Key indicator lights	28
Power lock function.....	28
Keys sound	29

DPMS mode.....	29
Luminance target.....	30
Viewing modes.....	30
Display functions.....	31
Ambient Light Compensation (ALC).....	32
Reading rooms.....	33
Image scaling.....	35
Image source selection modes.....	35
Video input signals.....	37
Video encoding modes.....	38
Grayscale conversion modes.....	39
Video timings.....	41
Display info.....	42
Display status.....	42
Cleaning your display.....	43
Front glass.....	43
Cabinet.....	44
Repackaging instructions.....	45
Important information.....	47
Safety information.....	47
Environmental information.....	50
Regulatory compliance information.....	53
Explanation of symbols.....	54
Legal disclaimer.....	55
Technical specifications.....	57
Warranty statement.....	60
Open source license information.....	63

What's in the box

Your CORONIS FUSION 10MP display comes with:

- this CORONIS FUSION 10MP display guide
- a system CD
- two DVI cables
- two DisplayPort cables
- a USB cable
- a set of AC power cords
- an external power supply

If you ordered a Barco display controller, it's also in the box together with its accessories. A dedicated user guide is available on the system CD.



Keep your original packaging. It is designed for this display and is the ideal protection during transport.

Parts, controls and connectors

Front view

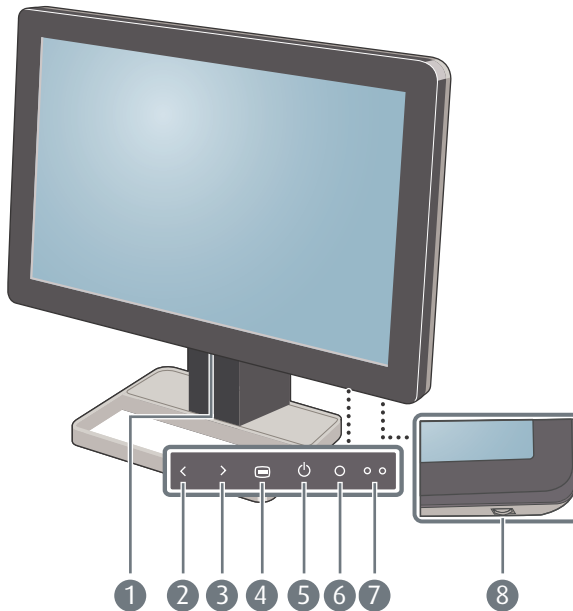

-
- | | |
|--------------------------------|------------------------|
| 1 USB downstream connectors | 2 Left/Up key |
| 3 Right/Down key | 4 Menu/Enter key |
| 5 Stand-by/Cancel key | 6 Ambient light sensor |
| 7 Power status indicator light | 8 Control wheel |
-

Rear view

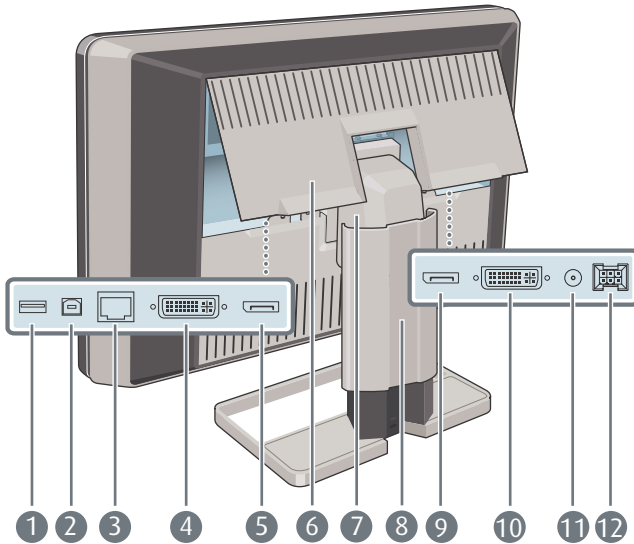

- | | | | |
|----|-------------------------------------|----|-----------------------------|
| 1 | USB downstream connector | 2 | USB upstream connector |
| 3 | Ethernet connector (see note below) | 4 | DVI 1 video input |
| 5 | DisplayPort 1 video input | 6 | Connector compartment cover |
| 7 | Neck cover | 8 | Display stand cover |
| 9 | DisplayPort 2 video input | 10 | DVI 2 video input |
| 11 | +5 VDC, 0.5 A power output | 12 | +24 VDC power input |



The Ethernet connection is used for maintenance purposes and is not supported for user application.

Display installation



Prior to installing your CORONIS FUSION 10MP display and connecting all necessary cables, make sure to have a suitable display controller physically installed in your computer. If you are using a Barco display controller, please consult the dedicated user guide available on the system CD.

Removing the covers

CONNECTOR COMPARTMENT COVER

The connector compartment cover should be removed to get access to the connectors. To remove the cover, proceed as follows:

- 1 Gently lift the clips at one of the handles of the connector compartment cover to release that side of the cover.
- 2 Do the same at the other side of the cover.
- 3 Remove the cover.

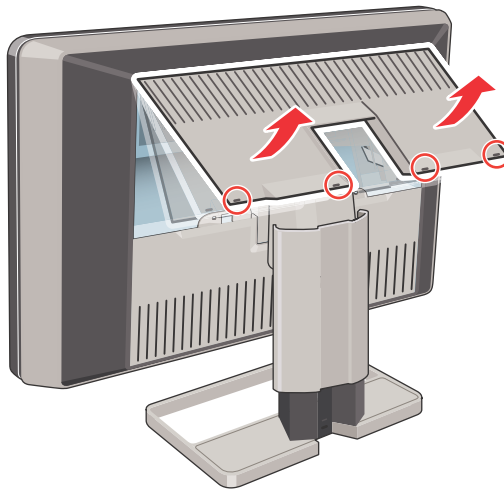

DISPLAY STAND COVER

To get access to the cable routing channel, the display stand cover should be removed. This can be done as follows:

- 1 Gently press and hold the clips at the inside top of the cover.

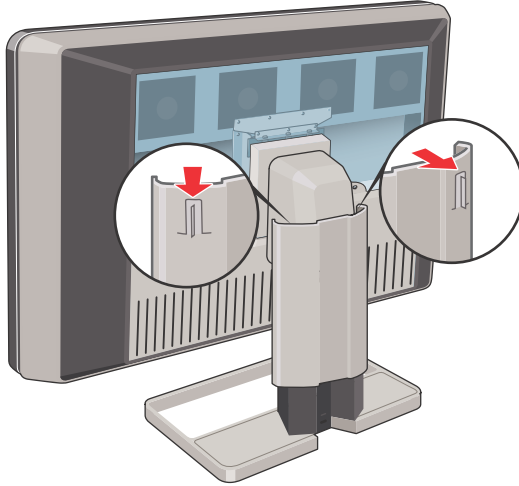

- 2 Slide the cover upwards while holding the clips pressed.

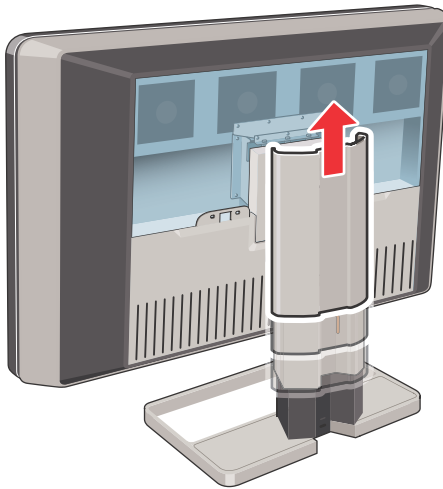

Unlocking the height mechanism

In the factory, the height-positioning system in the display stand is locked with a red hook to prevent damage during transportation. You'll have to remove this hook before adjusting your display height position.

- 1 While holding the display panel pushed down, pull out the red hook in the display stand.

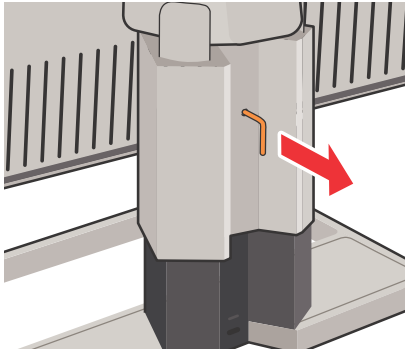

To retain the hook for possible future transportation, insert the short, red end of the hook back into the stand of your display.

Adjusting the display position

Now that the height-positioning system of your display is unlocked, you can tilt, swivel, raise and lower the display as desired.



Do not try to pivot your display when attached to the stand. Trying to do so could cause serious damage to your display and its stand.

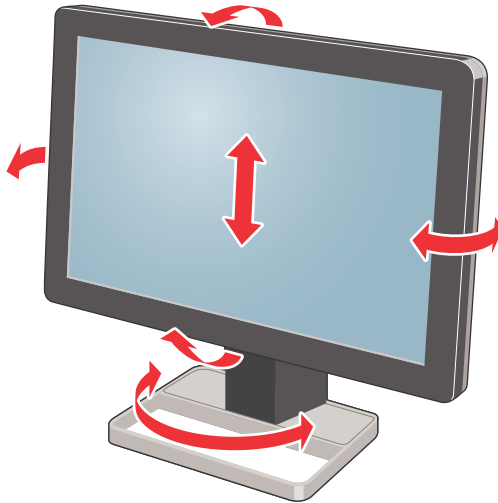

Connecting the signal cables

- 1 Connect one head of the display controller to the DVI 1 or DisplayPort 1 connector with one of the supplied DVI or DisplayPort cables.
- 2 Connect another head of the display controller to the DVI 2 or DisplayPort 2 connector with one of the supplied DVI or DisplayPort cables.



Each side of your display can have a different video input connected (one side can have DVI connected while the other side has DisplayPort connected). Both display sides can have the same video input connected as well but only one video input is allowed on each side of your display.

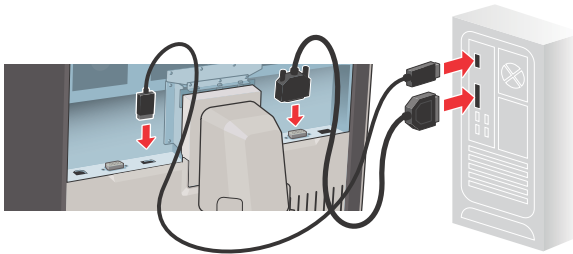

- 3 If you want to make use of your display's USB downstream connectors, connect a PC USB downstream connector to the display's USB upstream connector by means of the supplied USB 2.0 cable.

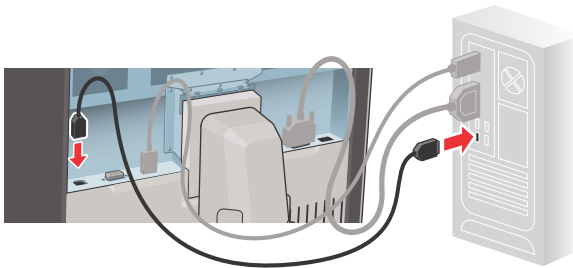

Connecting the power cables

- 1 Connect the supplied external DC power supply to the +24 VDC power input of your CORONIS FUSION 10MP display.
- 2 Plug the other end of the external DC power supply into a **grounded** power outlet by means of the proper power cord delivered in the packaging.

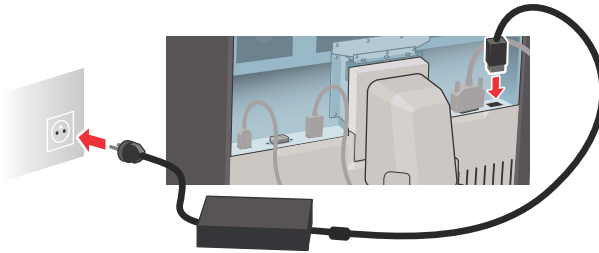

Routing the cables

Route all connected cables through the cable routing channel in the stand of your display.



The cable straps at the inside of the connector compartment allow you to fix the cables for better shielding of the cables.

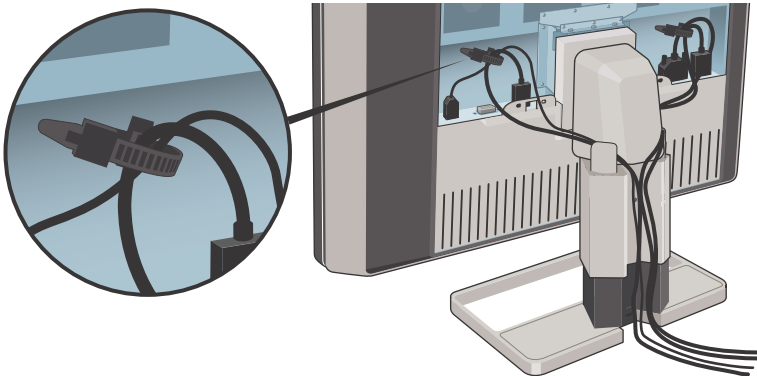

Re-attaching the covers

- 1 Re-attach the display stand cover by sliding it downward. You'll hear a "click" sound of the cover's clips when the display stand cover is in position.



Pay attention that all cables stay in the cable channel while replacing the cover.

- 2 Re-attach the connector compartment cover by sliding the cover's top in position and then push the cover's bottom. You'll hear a "click" sound of the cover's clips when the connector compartment cover is in position.

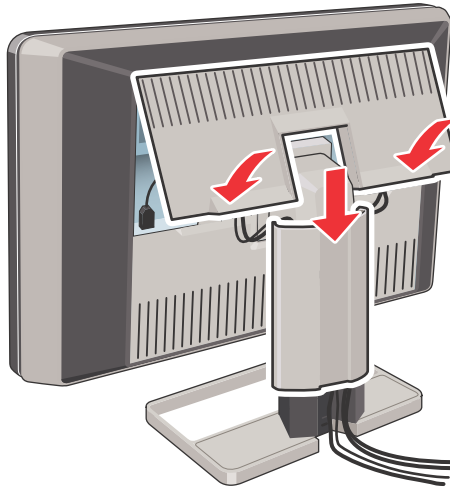

VESA-mount installation

The panel, standard attached to a stand, is compatible with the VESA 100 mm standard. Thus, it can be used with an arm that is approved by VESA. This chapter shows you how to release the panel from the stand and how to attach it to an arm. If you're not using an arm, you can skip this chapter.

- 1 Gently pull open both lower sides of the cover.

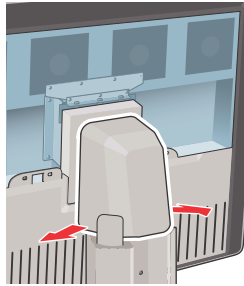

- 2 Slide the cover upwards while holding the lower sides pulled open.

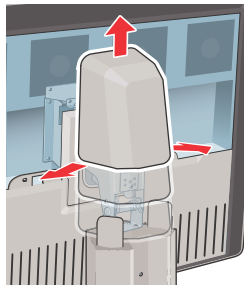

- 3 Lift the plastic frame that covers the fixation of the panel to the stand. Turn it for 45 degrees to uncover the fixation screws.

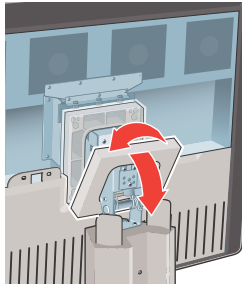

- 4 Unscrew the four fixation screws fixing the panel to the stand.

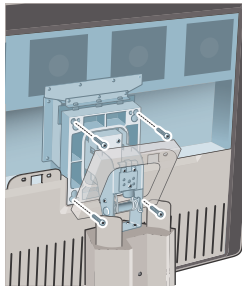

- 5 Attach the panel **firmly** to the arm using 4 screws M4 x 10 mm.



You should mount the panel in landscape position. Portrait position is possible but not supported.



Use an arm that can support a weight of at least 18 kg (39.68 lbs). Failure to do so could make the panel fall, causing serious injury to a child or adult, and serious damage to the equipment.

First time starting up

You are now ready to start up your CORONIS FUSION 10MP display system for the first time.

- 1 Switch on your CORONIS FUSION 10MP display as described in “**Stand-by switching**” on page 23.
- 2 Turn on the computer connected to your display.

If you have properly installed your display and display controller, the Windows start-up messages will appear once the boot procedure is finished.



Your CORONIS FUSION 10MP display will be running in a basic video mode at a default refresh rate when first time starting up.

If you are using a Barco display controller, please consult the dedicated user guide available on the system CD to install the drivers, software and documentation. When this is done, your display will automatically detect the connected video input signal(s) and apply the correct video mode and refresh rate.

Daily operation

Recommendations for daily operation

OPTIMIZE THE LIFETIME OF YOUR DISPLAY

Enabling the Display Power Management System (DPMS) of your display will optimize its diagnostic lifetime by automatically switching off the backlight when the display is not used for a specified period of time. By default, DPMS is enabled on your display, but it also needs to be activated on your workstation. To do this, go to “Power Options Properties” in the “Control Panel”.



Barco recommends setting DPMS activation after 20 minutes of non-usage.

USE A SCREEN SAVER TO AVOID IMAGE RETENTION

Prolonged operation of an LCD with the same content on the same screen area may result in a form of image retention.

You can avoid or significantly reduce the occurrence of this phenomenon by using a screen saver. You can activate a screen saver in the “Display properties” window of your workstation.



Barco recommends setting screen saver activation after 5 minutes of non-usage. A good screen saver displays moving content.

In case you are working with the same image or an application with static image elements for several hours continuously (so that the screen saver is not activated), change the image content regularly to avoid image retention of the static elements.

UNDERSTAND PIXEL TECHNOLOGY

LCD displays use technology based on pixels. As a normal tolerance in the manufacturing of the LCD, a limited number of these pixels may remain either dark or permanently lit, without affecting the diagnostic

performance of the product. To ensure optimal product quality, Barco applies strict selection criteria for its LCD panels.



To learn more about LCD technology and missing pixels, consult the dedicated white papers available at www.barco.com/medical.

ENHANCE USER COMFORT

Every Barco multi-head display system is color matched with the highest specification in the market.



Barco recommends keeping color-matched displays together. Furthermore, it is important to use all displays of a multi-head configuration at the same rate to preserve color matching throughout the economic lifetime of the system.

MAXIMIZE QUALITY ASSURANCE

The 'MediCal QAWeb' system offers online service for high-grade Quality Assurance, providing maximum diagnostic confidence and uptime.



Barco recommends to install MediCal QAWeb Agent and apply the default QAWeb policy at least. This policy includes calibration on regular intervals. Upgrading to MediCal QAWeb Server offers even more possibilities. Learn more and sign up for the free MediCal QAWeb Essential level at www.barco.com/medical/qa

Key indicator lights

By default, the key indicator lights will be dimmed which makes them unavailable at that moment.

TO MAKE THE KEYS LIGHT UP:

- 1 Gently sweep your finger over the bottom right hand side of your display.

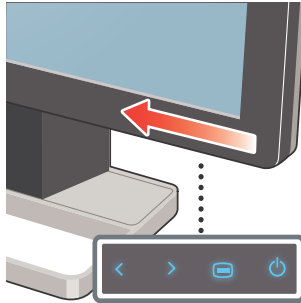

As a result, the keys will light up and are now available for further actions. However, if no further actions are taken within the following 5 seconds, the key indicator lights will dim again.



The key indicator lights auto-dim function can be disabled in the OSD menu. Please refer to **“Key indicator lights”** on page 28 for detailed instructions on how to do this.

Stand-by switching

Switching on the display while it is in stand-by mode or vice versa can both be done by using the keys or by using the control wheel.

To SWITCH YOUR DISPLAY ON/STAND-BY USING THE KEYS:

- 1 Light up the keys indicator lights as previously described.
- 2 While the keys are light up, touch the Stand-by/Cancel  key for approximately 2 seconds.

To SWITCH YOUR DISPLAY ON/STAND-BY USING THE CONTROL WHEEL:

- 1 Press and hold the control wheel for approximately 2 seconds.

As a result, the display will switch on or will switch to stand-by mode. When the display is **switched on**, the power status indicator light is **dimmed**. When the display is in **stand-by mode**, the power status indicator light is **orange**.



The power status indicator light can be enabled in the OSD menu so that it will turn **blue** when the display is **switched on**. Please refer to **“Power status indicator light”** on page 27 for detailed instructions on how to do this.



In case of a power outage recovery, your display will always start-up in the power mode it was in before the power interruption (i.e. stand-by or on). This protects your display against inadvertent image retention problems.

Bringing up the OSD menu

The OSD menu allows you to configure different settings to make your CORONIS FUSION 10MP display fit your needs within your working environment. Also, you can retrieve general information about your display and its current configuration settings through the OSD menu.

TO BRING UP THE OSD MENU USING THE KEYS:

- 1 If not already done so, switch on the display as previously described.
- 2 Light up the keys indicator lights as previously described.
- 3 While the keys light up, touch the Menu/Enter  key.

TO BRING UP THE OSD MENU USING CONTROL WHEEL:

- 1 If not already done so, switch on the display as previously described.
- 2 Shortly press the control wheel.

As a result, the OSD main menu comes up in the bottom right corner of the screen. If no further actions are taken within the following 90 seconds however, the OSD menu will disappear again.



The OSD menu automatic close function can be disabled in the OSD menu. Please refer to **“OSD menu automatic close function”** on page 27 for detailed instructions on how to do this.



The OSD menu position can be modified in the OSD menu. Please refer to **“OSD menu position”** on page 26 for detailed instructions on how to do this.





Navigating through the OSD menus

ABOUT OSD MENU NAVIGATION

Navigating through the OSD menu can be done by using the keys or by using the control wheel.

TO NAVIGATE THE OSD MENU USING THE KEYS:

- Use the Right/Down > and Left/Up < keys to move through the (sub)menus, change values or make selections.
- To go into a submenu or confirm adjustments and selections, use the Menu/Enter  key.
- Use the Stand-by/Cancel  key to cancel adjustments or exit a (sub)menu.
- Exit the OSD menu by touching the Stand-by/Cancel  key for approximately 2 seconds.

TO NAVIGATE THE OSD MENU USING THE CONTROL WHEEL:

- Rotate the control wheel to move through the menus, change values or make selections.
- To go into a submenu or confirm adjustments and selections, shortly click the control wheel.
- Click the control wheel for approximately 2 seconds to cancel adjustments or exit a (sub)menu.

Advanced operation



OSD menu position

ABOUT THE OSD MENU POSITION

By default, the OSD menu comes up in the bottom right corner of the screen. This position can be modified however. There's choice from a number of predefined positions.

TO CHANGE THE POSITION OF THE OSD MENU:

- 1 Bring up the OSD main menu.
- 2 Navigate to the **Configuration** > **User Interface** > **Menu** menu.
- 3 Enter the **Position** submenu.
- 4 Select one of the available OSD menu positions and confirm.



OSD menu language

ABOUT THE OSD MENU LANGUAGE

By default, the OSD menu comes up in English. However, there's a wide range of other languages available for the OSD menu of your CORONIS Fusion 10MP display.

TO CHANGE THE LANGUAGE OF THE OSD MENU:

- 1 Bring up the OSD main menu.
- 2 Navigate to the **Configuration** > **User Interface** > **Menu** menu.
- 3 Enter the **Language** submenu.
- 4 Select one of the available languages and confirm.



OSD menu automatic close function

ABOUT THE OSD MENU AUTOMATIC CLOSE FUNCTION

By default, the OSD menu will disappear automatically after approximately 90 seconds of inactivity. However, this function can be disabled so that the OSD menu remains on the screen until manually closed.

TO ENABLE/DISABLE THE OSD MENU AUTOMATIC CLOSE FUNCTION:

- 1 Bring up the OSD main menu.
- 2 Navigate to the **Configuration** > **User Interface** > **Menu** menu.
- 3 Enter the **Automatic Close** submenu.
- 4 Select **Enabled/Disabled** as desired and confirm.



Power status indicator light

ABOUT THE POWER STATUS INDICATOR LIGHT

By default, when the display is switched on, the power status indicator light is dimmed. This behavior can be changed so that the power status indicator light will be **blue** when the display is switched on.



When the display is in stand-by mode, the power status indicator light will always turn orange, even when the power status indicator light is disabled.

TO ENABLE/DISABLE THE POWER STATUS INDICATOR LIGHT:

- 1 Bring up the OSD main menu.
- 2 Navigate to the **Configuration** > **User Interface** > **Indicator Lights** menu.
- 3 Enter the **Power Status** submenu.
- 4 Select **Enabled/Disabled** as desired and confirm.



Key indicator lights

ABOUT THE KEY INDICATOR LIGHTS

By default, after lighting up, the key indicator lights will dim again if no further actions are taken within the following 5 seconds. However, this behavior can be changed so that the key indicator lights are always on or always off.

TO CONFIGURE THE KEY INDICATOR LIGHTS:

- 1 Bring up the OSD main menu.
- 2 Navigate to the **Configuration** > **User Interface** > **Indicator Lights** menu.
- 3 Enter the **Keys** submenu.
- 4 Select **Automatic/Always On/Always Off** as desired and confirm.



Power lock function

ABOUT THE POWER LOCK FUNCTION

By enabling the power lock function, the CORONIS FUSION 10MP display is forced to remain switched on. This means that it can't be switched to stand-by mode until the power lock function is disabled again.

TO ENABLE/DISABLE THE POWER LOCK FUNCTION:

- 1 Bring up the OSD main menu.
- 2 Navigate to the **Configuration** > **User Interface** > **Controls** menu.
- 3 Enter the **Power Lock** submenu.
- 4 Select **Enabled/Disabled** as desired and confirm.



Keys sound

ABOUT THE KEYS SOUND

By default, the keys will make a “beep” sound on every touch. However, this sound can be disabled so that no sound will be heard when using the keys.

TO ENABLE/DISABLE THE KEYS SOUND:

- 1 Bring up the OSD main menu.
- 2 Navigate to the **Configuration** > **User Interface** > **Controls** menu.
- 3 Enter the **Sound** submenu.
- 4 Select **Enabled/Disabled** as desired and confirm.



DPMS mode

ABOUT DPMS MODE

Enabling the Display Power Management System (DPMS) mode on your display will optimize its diagnostic lifetime by automatically switching off the backlight when the display is not used for a specified period of time. By default, DPMS mode is enabled on your display, but it also needs to be activated on your workstation. To do this, go to the “Power options properties” window of your workstation.



Barco recommends setting DPMS activation after 20 minutes of non-usage.

TO ENABLE/DISABLE DPMS MODE ON YOUR DISPLAY:

- 1 Bring up the OSD main menu.
- 2 Navigate to the **Configuration** > **Power Management** menu.
- 3 Enter the **DPMS Mode** submenu.
- 4 Select **Enabled/Disabled** as desired and confirm.



Luminance target

ABOUT THE LUMINANCE TARGET

The luminance target of your CORONIS FUSION 10MP display is adjustable over a predefined range. When you change the luminance target, the display will adjust its backlight to reach the target.

TO SET THE LUMINANCE TARGET:

- 1 Bring up the OSD main menu.
- 2 Navigate to the **Configuration** > **Calibration** menu.
- 3 Enter the **Luminance Target** submenu.
- 4 Set a luminance target value as desired and confirm.



Viewing modes

ABOUT VIEWING MODES

The CORONIS FUSION 10MP display can be used in two viewing modes:

Diagnostic	This mode provides the full calibrated luminance and is intended for using the display for diagnostic purposes.
Text	In this mode, the luminance is reduced to approximately half of the luminance. This is intended for using the display with office applications such as word processing.



As the CORONIS FUSION 10MP display is intended to be used in a diagnostic environment, the diagnostic mode should always be selected.

TO SELECT A VIEWING MODE:

- 1 Bring up the OSD main menu.
- 2 Navigate to the **Configuration** > **Calibration** menu.
- 3 Enter the **Viewing Mode** submenu.
- 4 Select **Diagnostic/Text** as desired and confirm.



Display functions

ABOUT DISPLAY FUNCTIONS

Native, uncorrected panels will display all grayscale/color levels at an equal luminance. Studies have shown however, that in medical images certain grayscale/color parts contain more diagnostic information than others. To respond to these conclusions, display functions have been defined. These functions emphasize on these parts containing crucial diagnostic information by correcting the native panel behavior.

Native	If you select Native, the native panel behavior will not be corrected.
Dynamic Gamma 1.8 Dynamic Gamma 2.2	These are gamma functions that are shifted to take into account the non-zero luminance of an LCD panel when driven with a "black" signal. They are especially useful in CT applications to improve the perception of low Hounsfield values.

DICOM	DICOM (Digital Imaging and Communications in Medicine) is an international standard that was developed to improve the quality and communication of digital images in radiology. In short, the DICOM display function results in more visible greyscales in the images. Barco recommends selecting the DICOM display function for most medical viewing applications.
User	This display function will be automatically selected when display functions are defined by MediCal QAWeb.
Gamma 1.8 Gamma 2.2	Select one of these display functions in case the display is to replace a CRT display with a gamma of 1.8 or 2.2 respectively.

TO SELECT A DISPLAY FUNCTION:

- 1 Bring up the OSD main menu.
- 2 Navigate to the **Configuration** > **Calibration** menu.
- 3 Enter the **Display Function** submenu.
- 4 Select one of the available display functions and confirm.



Ambient Light Compensation (ALC)

ABOUT ALC



Ambient Light Compensation (ALC) can only be enabled on your display when the DICOM display function is selected. Therefore, please refer to “**Display functions**” on page 31 to correctly set the display function.

When ALC is enabled, the DICOM display function will be recalculated taking a preset ambient light correction value into account. This value is

determined by the selected reading room. Therefore, it is also important to select a realistic reading room when enabling ALC. This can be done by following the instructions in “**Reading rooms**” on page 33.

TO ENABLE/DISABLE ALC:

- 1** Bring up the OSD main menu.
- 2** Navigate to the **Configuration > Calibration > Ambient Light** menu.
- 3** Enter the **Ambient Light Compensation** submenu.
- 4** Select **Enabled/Disabled** as desired and confirm.



Reading rooms

ABOUT READING ROOMS



Reading rooms can only be selected when the DICOM display function is selected. Therefore, please refer to “**Display functions**” on page 31 to correctly set the display function.

The American Association of Physicists in Medicine (AAPM) composed a list of pre-defined reading rooms. Each of these reading rooms are defined by following parameters:

- the maximum light allowed in this type of room
- the preset ambient light correction value for this reading room

These parameters are stored in your display and determine the preset ambient light correction value to take into account to recalculate the DICOM display function when Ambient Light Compensation (ALC) is

enabled. Please refer to “**Ambient Light Compensation (ALC)**” on page 32 to enable ALC.

The available reading rooms for your CORONIS FUSION 10MP display are:

CR/DR/MAMMO	Corresponds to light conditions in diagnostic reading rooms for computed radiology, digital radiology or mammography. This setting has the lowest maximum ambient light.
CT/MR/NM	Corresponds to light conditions in diagnostic reading rooms for computed tomography, magnetic resonance or nuclear medicine scans.
Staff Office	Corresponds to light conditions in office rooms.
Clinical Viewing Room	Corresponds to light conditions in diagnostic reading rooms for clinical viewing.
Emergency Room	Corresponds to light conditions in emergency rooms.
Operating Room	Corresponds to light conditions in operating rooms. This setting has the highest maximum ambient light.

TO SELECT A READING ROOM:

- 1** Bring up the OSD main menu.
- 2** Navigate to the **Configuration > Calibration > Ambient Light** menu.
- 3** Enter the **Reading Room** submenu.
- 4** Select one of the available reading rooms and confirm.



Image scaling

ABOUT IMAGE SCALING

Enabling image scaling will multiply each individual pixel to one or more adjacent pixels so that the size of the displayed image will be a multiple of the original image source video input signal.



Image scaling is only possible when the resolution of your display's video input signal is less than or equal to half the maximum resolution of the display.

TO ENABLE/DISABLE IMAGE SCALING:

- 1 Bring up the OSD main menu.
- 2 Navigate to the **Configuration** > **Image Sources** menu.
- 3 Enter the **Scaling** submenu.
- 4 Select **Enabled/Disabled** as desired and confirm.



Image source selection modes

ABOUT IMAGE SOURCE SELECTION MODES

Your CORONIS FUSION 10MP display automatically detects the number of video input signals connected, attaches them to the correct display side and applies the correct video settings to it (resolution, video encoding mode, refresh rate,...). However, it may be needed to manually select the video input signal(s) to be displayed on a certain display side or to

adjust certain video settings yourself. The start to this is selecting one of the following image source selection modes available for your display:

Automatic	In this mode, your display automatically detects the connected video input signals, attaches them to the correct display side and applies the correct video settings to it (resolution, video encoding mode, refresh rate,...). No video settings are available when this mode is selected.
One Image Source	This mode is intended for displaying and manually configuring only one connected video input signal. When selecting this mode, the video settings become available for the selected video input signal.
Two Image Sources	This mode is intended for displaying and manually configuring two connected video input signals (one on each display side). When selecting this mode, the video settings become available for the selected video input signal on each side of the display.

TO SELECT AN IMAGE SOURCE SELECTION MODE:

- 1 Bring up the OSD main menu.
- 2 Navigate to the **Configuration > Image Sources** menu.
- 3 Enter the **Image Source Selection** submenu.
- 4 Select one of the available image source selection modes and confirm.



Video input signals

ABOUT VIDEO INPUT SIGNALS



Your CORONIS FUSION 10MP display automatically detects the connected video input signals. Manually selecting image source video input signals is possible, but then your display's image source selection mode should be set to allow this. Please refer to **"Image source selection modes"** on page 35 to do this.

The available input signals for your display are:

DisplayPort 1	This input corresponds to the DisplayPort 1 connector as shown in the "Parts, controls and connectors" section.
DVI 1	This input corresponds to the DVI 1 connector as shown in the "Parts, controls and connectors" section.
DisplayPort 2	This input corresponds to the DisplayPort 2 connector as shown in the "Parts, controls and connectors" section.
DVI 2	This input corresponds to the DVI 2 connector as shown in the "Parts, controls and connectors" section.

TO MANUALLY SELECT A VIDEO INPUT SIGNAL:

- 1 Bring up the OSD main menu.
- 2 Navigate to the **Configuration > Image Sources > (Left/Right) Image Source** menu.
- 3 Enter the **Input Signal** submenu.
- 4 Select one of the available input signals and confirm.



Video encoding modes

ABOUT VIDEO ENCODING MODES



Your CORONIS FUSION 10MP display automatically detects the connected video input signals and applies the correct video encoding settings. Manually selecting a video encoding mode is possible, but then your display's image source selection mode should be set to allow this. Please refer to **"Image source selection modes"** on page 35 to do this.

Video encoding modes specify how the color and luminance information is encoded in the video signal. In consumer displays, this is usually done by a limited 8-bit encoding mechanism. Your CORONIS FUSION 10MP display however, features 10-bit encoding enabling it to better match the DICOM defined grayscale range. Such an extensive range is necessary to comply with the guidelines set forward by the latest medical guidelines.

The available video encoding modes for your display are listed below.



Please note that the display controller connected to your display might not always support all these video encoding modes.

Standard	This mode uses the standard 8 bit encoding mechanism.
HDR1	This mode features 10-bit video encoding following the High Dynamic Range (HDR) standard, usually used on color displays.
HDR2	HDR2 is a Barco specific mode featuring 10-bit video encoding following the High Dynamic Range (HDR) standard but allowing full refresh rate (which is not always possible with HDR1). This mode is usually used on color displays.

Dual 10	Dual 10 is a Barco specific 10-bit video encoding mode which is usually used on grayscale displays and which allows full refresh rate.
Automatic	When selecting this option, your CORONIS FUSION 10MP display will automatically assign the correct video encoding settings to the connected video input signals.

TO MANUALLY SELECT A VIDEO ENCODING MODE:

- 1 Bring up the OSD main menu.
- 2 Navigate to the **Configuration > Image Sources > (Left/Right) Image Source** menu.
- 3 Enter the **Video Encoding** submenu.
- 4 Select one of the available video encoding modes and confirm.



Grayscale conversion modes

ABOUT GRAYSCALE CONVERSION MODES



Your CORONIS FUSION 10MP display automatically detects the connected video input signals and applies the correct grayscale conversion settings. Manually selecting a grayscale conversion mode is possible, but then your display's image source selection mode should be set to allow this. Please refer to **"Image source selection modes"** on page 35 to do this.

Grayscale conversion modes specify how color generated on the display controller is converted to grayscale in your display.

The available grayscale conversion modes are:

Use Red Channel	This mode is intended for grayscale displays where gray is sent over the red channel.
------------------------	---

Use Green Channel	This mode is intended for grayscale displays where gray is sent over the green channel.
Use Blue Channel	This mode is intended for grayscale displays where gray is sent over the blue channel.
Use All Channels	This mode is intended for grayscale displays where gray is sent over the red, green and blue channel. This done by means of a standard conversion mechanism where 30% red, 59% green and 11% blue are used to generate gray.

TO MANUALLY SELECT A GRAYSCALE CONVERSION MODE:

- 1** Bring up the OSD main menu.
- 2** Navigate to the **Configuration > Image Sources > (Left/Right) Image Source** menu.
- 3** Enter the **Grayscale Conversion** submenu.
- 4** Select one of the available color conversion modes and confirm.



Video timings

ABOUT VIDEO TIMINGS



Your CORONIS FUSION 10MP display automatically detects the connected video input signals and applies the correct timings. Manually configuring the video timings is possible, but then your display's image source selection mode should be set to allow this. Please refer to **"Image source selection modes"** on page 35 to do this.

Following video timings are available for your CORONIS FUSION 10MP display:

Resolution	Allows to manually modify the resolution of the image source video input signal.
Refresh Rate	Allows to manually select the refresh rate of the image source video input signal depending on the maximum refresh rate of the display controller connected to your display.
Color Depth	Allows to change the color depth to 8 or to 10 bit.

TO MANUALLY SET VIDEO TIMINGS:

- 1 Bring up the OSD main menu.
- 2 Navigate to the **Configuration > Image Sources > (Left/Right) Image Source** menu.
- 3 Enter the **Timings** submenu.
- 4 Select **Resolution, Refresh Rate** or **Color Depth**.
- 5 Select one of the available settings and confirm.



Display info

ABOUT DISPLAY INFO

Your display serial number, color type, native resolution, firmware versions, etc. are available in a dedicated submenu of the OSD menu.

TO RETRIEVE INFO ABOUT YOUR DISPLAY:

- 1 Bring up the OSD main menu.
- 2 Navigate to the **About this Display** menu.
- 3 Enter the **Display** or **Firmware** submenu as desired.



Display status

ABOUT DISPLAY STATUS

The Status submenu of the OSD menu provides info on the current status of your display (runtimes, temperatures, etc.), the status of the connected image sources (video encoding mode, timings, etc.) and the current calibration status of your display (display function, luminance, ALC, etc.).

TO RETRIEVE THE STATUS OF YOUR DISPLAY:

- 1 Bring up the OSD main menu.
- 2 Navigate to the **Status** menu.
- 3 Enter the **Display**, **Image Source** or **Calibration** submenu as desired.

Cleaning your display

Front glass



Before cleaning the front glass, unplug the power cable from the mains to prevent the keys from being activated inadvertently by sweeping over them.

Clean the front glass using a sponge, cleaning cloth or soft tissue, **lightly** moistened with one of the following tested products:

- Flux
- Windex Glass Plus
- Bohle glass cleaner
- Mr. Proper
- Pril
- Ajax glass cleaner
- Sidolin glass cleaner
- 25% ethanol solution (EtOH)

In case none of the above cleaning products is available, use plain water.



Take care not to damage or scratch the front glass. Be careful with rings or other jewelry and do not apply excessive pressure on the front glass.



Do not apply or spray liquid directly to the front glass as excess liquid may cause damage to internal electronics. Instead, apply the liquid to the cleaning cloth.



Do not use following products:

- Alcohol/solvents at higher concentration > 5%
- Strong alkalis lye, strong solvents
- Acid
- Detergents with fluoride
- Detergents with ammonia
- Detergents with abrasives
- Steel wool
- Sponge with abrasives
- Steel blades
- Cloth with steel thread

Cabinet

- 1 Clean the cabinet using a soft cotton cloth, **lightly** moistened with a recognized cleaning product for medical equipment.

The cabinet has been tested for resistance to the following products:

- Cidex, Betadine
- Alcohol (Isopropyl and Ethyl)
- Ammonia-based cleaners (Windex)
- Aquasonic Gel

In case none of the above cleaning products is available, use plain water.



Do not apply or spray liquid directly to the cabinet as excess liquid may cause damage to internal electronics. Instead, apply the liquid to the cleaning cloth.

- 2 Repeat with water only.
- 3 Wipe dry with a dry cloth.

Repackaging instructions

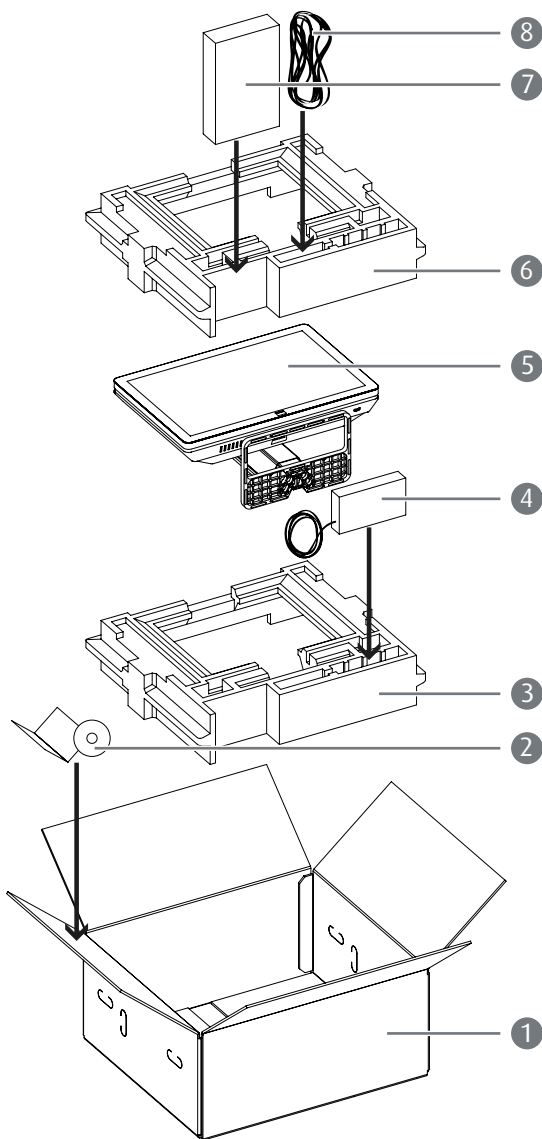

1	Box	2	System CD + User guide
3	Bottom buffer	4	Power supply
5	CORONIS FUSION 10MP display	6	Top buffer
7	Display controller box	8	Cables (video, USB, power)

- 1 Place the empty box on a stable surface.
- 2 Slide the system CD and user guide in the dedicated bag attached at the inside of the box.
- 3 Place the bottom buffer in the box.
- 4 Put the power supply in the dedicated cavity of the bottom buffer.
- 5 Put the CORONIS FUSION 10MP display in its original bag and place it in the box with its panel facing upwards.
- 6 Put the top buffer on top of the display.
- 7 When applicable, slide the display controller box in the dedicated cavity of the buffers.
- 8 Put all cables (video, USB, power) in their original bag and slide them in the dedicated cavity of the buffers.
- 9 Close and seal the box.

Important information

Safety information

GENERAL RECOMMENDATIONS

Read the safety and operating instructions before operating the display.

Retain safety and operating instructions for future reference.

Adhere to all warnings on the display and in the operating instructions manual.

Follow all instructions for operation and use.

ELECTRICAL SHOCK

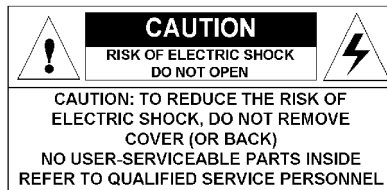

TYPE OF PROTECTION (ELECTRICAL):

Display with external power supply: Class I equipment

DEGREE OF SAFETY (FLAMMABLE ANESTHETIC MIXTURE):

Equipment not suitable for use in the presence of a flammable anesthetic mixture with air or with oxygen or nitrous oxide.

NON-PATIENT CARE EQUIPMENT

Equipment primarily for use in a health care facility that is intended for use where contact with a patient is unlikely.

POWER CONNECTION - DISPLAY WITH EXTERNAL 24 VDC POWER SUPPLY

- Power requirements: The display must be powered using the delivered medical approved 24 VDC SELV power supply.
- The medical approved DC power supply must be powered by the AC mains voltage (protective earth terminal).

POWER CORDS:

- Utilize a UL-listed detachable power cord, 3-wire, type SJ or equivalent, 18 AWG min., rated 300 V min., provided with a hospital-grade type plug 5-15P configuration for 120V application, or 6-15P for 240V application.
- Do not overload wall outlets and extension cords as this may result in fire or electric shock.
- Mains lead protection (U.S.: Power cord): Power cords should be routed so that they are not likely to be walked upon or pinched by items placed upon or against them, paying particular attention to cords at plugs and receptacles.

WATER AND MOISTURE

Never expose the display to rain or moisture.

Never use the display near water - e.g. near a bathtub, washbasin, swimming pool, kitchen sink, laundry tub or in a wet basement.

VENTILATION

Do not cover or block the ventilation openings in the cover of the set. When installing the display in a cupboard or another closed location, heed the necessary space between the set and the sides of the cupboard.

INSTALLATION

Place the display on a flat, solid and stable surface that can support the weight of at least 3 displays. If you use an unstable cart or stand, the

display may fall, causing serious injury to a child or adult, and serious damage to the equipment.

THIS APPARATUS CONFORMS TO:

CE0120 (MDD 93/42/EEC class IIb product), CE - 2004/108/EC, CE - 93/42/EEC; A1:2007/47/EC class II b, UL 60601-1 1ST EDITION, CAN/CSA-C22.2 NO. 601.1-M90, IEC 60601-1 2ND ED:1988 + A1:1991 + A2:1995, IEC 60950-1:2005 2ND EDITION, DEMKO - EN 60601-1, VCCI, FCC class B, BSMI, FDA 510K, RoHS, KC

NATIONAL SCANDINAVIAN DEVIATIONS FOR CL. 1.7.2:

Finland: "Laite on liitettävä suojamaadoituskoskettimilla varustettuun pistorasiaan"

Norway: "Apparatet må tilkoples jordet stikkontakt"

Sweden: "Apparaten skall anslutas till jordat uttag"

Environmental information

DISPOSAL INFORMATION (WASTE ELECTRICAL AND ELECTRONIC EQUIPMENT)



This symbol on the product indicates that, under European Directive 2002/96/EC governing waste from electrical and electronic equipment, this product must not be disposed of with other municipal waste. Please dispose of your waste equipment by handing it over to a designated collection point for the recycling of waste electrical and electronic equipment. To prevent possible harm to the environment or human health from uncontrolled waste disposal, please separate these items from other types of waste and recycle them responsibly to promote the sustainable reuse of material resources.

For more information about recycling of this product, please contact your local city office, your municipal waste disposal service or the shop where you purchased the product.

MERCURY NOTICE

This Barco product consists of materials that may contain mercury, which must be recycled or disposed of in accordance with local, state, or country laws:

- Within this system, the backlight lamps in the monitor display contain mercury



TURKEY RoHS COMPLIANCE



Republic of Turkey: In conformity with the EEE Regulation
Türkiye Cumhuriyeti: EEE Yönetmeliğine Uygundur

中国大陆 RoHS (CHINESE MAINLAND ROHS)

根据中国大陆《电子信息产品污染控制管理办法》（也称为中国大陆 RoHS），以下部分列出了 Barco 产品中可能包含的有毒和/或有害物质的名称和含量。中国大陆 RoHS 指令包含在中国信息产业部 MCV 标准：“电子信息产品中有毒物质的限量要求”中。

According to the "China Administration on Control of Pollution Caused by Electronic Information Products" (Also called RoHS of Chinese Mainland), the table below lists the names and contents of toxic and/or hazardous substances that Barco's product may contain. The RoHS of Chinese Mainland is included in the MCV standard of the Ministry of Information Industry of China, in the section "Limit Requirements of toxic substances in Electronic Information Products".

零件项目 (名称) Component Name	有毒有害物质或元素 Hazardous Substances or Elements					
	铅 (Pb)	汞 (Hg)	镉 (Cd)	六价铬 (Cr6+)	多溴联苯 (PBB)	多溴二苯醚 (PBDE)
印制电路配件 Printed Circuit Assemblies	X	0	0	0	0	0
液晶面板 LCD panel	X	X	0	0	0	0
外接电(线)缆 External cables	X	0	0	0	0	0
内部线路 Internal wiring	0	0	0	0	0	0
金属外壳 Metal enclosure	0	0	0	0	0	0
塑胶外壳 Plastic enclosure	0	0	0	0	0	0
散热片(器) Heatsinks	0	0	0	0	0	0
风扇 Fan	0	0	0	0	0	0

电源供应器 Power supply unit	X	0	0	0	0	0
文件说明书 Paper manuals	0	0	0	0	0	0
光盘说明书 CD manual	0	0	0	0	0	0
<p>O: 表示该有毒有害物质在该部件所有均质材料中的含量均在 SJ/T 11363-2006 标准规定的限量要求以下。 O: Indicates that this toxic or hazardous substance contained in all of the homogeneous materials for this part is below the limit requirement in SJ/T11363-2006.</p> <p>X: 表示该有毒有害物质至少在该部件的某一均质材料中的含量超出 SJ/T 11363-2006 标准规定的限量要求。 X: Indicates that this toxic or hazardous substance contained in at least one of the homogeneous materials used for this part is above the limit requirement in SJ/T11363 2006.</p>						

在中国大陆销售的相应电子信息产品（EIP）都必须遵照中国大陆《电子信息产品污染控制标识要求》标准贴上环保使用期限（EFUP）标签。Barco 产品所采用的 EFUP 标签（请参阅实例，徽标内部的编号用于制定产品）基于中国大陆的《电子信息产品环保使用期限通则》标准。

All Electronic Information Products (EIP) that are sold within Chinese Mainland must comply with the "Electronic Information Products Pollution Control Labeling Standard" of Chinese Mainland, marked with the Environmental Friendly Use Period (EFUP) logo. The number inside the EFUP logo that Barco uses (please refer to the photo) is based on the "Standard of Electronic Information Products Environmental Friendly Use Period" of Chinese Mainland.



Regulatory compliance information

INDICATIONS FOR USE

The CORONIS FUSION 10MP display (MDCG-10130) is intended to be used in displaying and viewing digital images, including digital mammography, for review and analysis by trained medical practitioners.

Caution (USA): Federal law restricts this device to sale by or on the order of a physician. (Details & exemptions are in the Code of Federal Regulations Title 21, 801 Part D).

FCC CLASS B

This device complies with Part 15 of the FCC Rules. Operation is subject to the following two conditions: (1) this device may not cause harmful interference, and (2) this device must accept any interference received, including interference that may cause undesired operation.

This equipment has been tested and found to comply with the limits for a Class B digital device, pursuant to Part 15 of the FCC Rules. These limits are designed to provide reasonable protection against harmful interference in a residential installation. This equipment generates, uses and can radiate radio frequency energy and, if not installed and used in accordance with the instructions, may cause harmful interference to radio communications. However, there is no guarantee that interference will not occur in a particular installation. If this equipment does cause harmful interference to radio or television reception, which can be determined by turning the equipment off and on, the user is encouraged to try to correct the interference by one or more of the following measures:









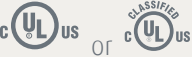

- Reorient or relocate the receiving antenna.
- Increase the separation between the equipment and receiver.
- Connect the equipment into an outlet on a circuit different from that to which the receiver is connected.
- Consult the dealer or an experienced radio/TV technician for help.

CANADIAN NOTICE

This ISM device complies with Canadian ICES-001.
Cet appareil ISM est conforme à la norme NMB-001 du Canada.

Explanation of symbols

On the display or power supply, you may find the following symbols (nonrestrictive list):

	Indicates compliance to the essential requirements of the Directive 93/42/EEC
	Indicates compliance with Part 15 of the FCC rules (Class A or Class B)
	Indicates the display is approved according to the UL regulations
	Indicates the display is approved according to the c-UL regulations
	Indicates the display is approved according to the DEMKO regulations
	Indicates the display is approved according to the CCC regulations
	Indicates the display is approved according to the VCCI regulations
	Indicates the USB connectors on the display
	Indicates the manufacturing date
	Indicates the temperature limitations for the display to operate within specs
	Indicates the display serial no.

	Consult the operating instructions
	Indicates this apparatus must not be thrown in the trash but must be recycled, according to the European WEEE (Waste Electrical and Electronic Equipment) directive

Legal disclaimer

DISCLAIMER NOTICE

Although every attempt has been made to achieve technical accuracy in this document, we assume no responsibility for errors that may be found. Our goal is to provide you with the most accurate and usable documentation possible; if you discover errors, please let us know.

Barco software products are the property of Barco. They are distributed under copyright by Barco N.V. or Barco, Inc., for use only under the specific terms of a software license agreement between Barco N.V. or Barco Inc. and the licensee. No other use, duplication, or disclosure of a Barco software product, in any form, is authorized.

The specifications of Barco products are subject to change without notice.

TRADEMARKS

All trademarks and registered trademarks are property of their respective owners.

COPYRIGHT NOTICE

This document is copyrighted. All rights are reserved. Neither this document, nor any part of it, may be reproduced or copied in any form or by any means - graphical, electronic, or mechanical including

photocopying, taping or information storage and retrieval systems -
without written permission of Barco.

© 2011 Barco N.V. All rights reserved.

PATENT INFORMATION

This product is covered under the following intellectual property rights:

US Patent 7,639,849

US Patent 7,038,186

US Patent 7,166,829

US Patent 6,950,098

European Patent 1 274 066.

Technical specifications

Product acronym	MDCG-10130
Screen technology	TFT AM LCD Dual Domain IPS
Active screen size (diagonal)	761 mm (29.6")
Active screen size (H x V)	645 x 403 mm (25.4 x 15.9")
Aspect ratio (H:V)	16:10
Resolution	native 10MP (4096 x 2560) configurable to 2 x 5MP (2048 x 2560)
Pixel pitch	0.1575 mm
Color imaging	No
Gray imaging	Yes
Number of grayscales (LUT in/LUT out)	1024 grey levels (10/12)
Viewing angle (H, V)	170°
Uniform Luminance Technology (ULT)	Yes
Per Pixel Uniformity (PPU)	No
Ambient Light Compensation (ALC)	Yes
Backlight Output Stabilization (BLOS)	Yes
I-Guard	Yes
Maximum luminance*	1250 cd/m ² (panel typical)
DICOM calibrated luminance (ULT off)*	500 cd/m ² (panel typical)
Contrast ratio (typical)*	950:1 (panel typical)
Response time (Tr + Tf)	35 ms

Scanning frequency (H; V)	30-150 kHz; 15-80 Hz
Housing color	Black/Silver
Video input signals	DVI-D Dual Link (2x) / DisplayPort (2x)
Video inout terminals	NA
USB ports	1 upstream (endpoint), 3 downstream
USB standard	2.0
Power requirements (nominal)	100-240V
Power consumption (nominal)	102W
Power save mode	Yes
Power management	DVI-DMPM / DP-DMPM
Dot clock	280 MHz
OSD languages	English, German, French, Dutch, Spanish, Italian, Portuguese, Polish, Russian, Swedish, Chinese (simplified), Japanese, Korean, Arabic
Dimensions with stand (W x H x D)	Portrait: NA Landscape: 731 x 580~670 x 270 mm
Dimensions w/o stand (W x H x D)	Portrait: NA Landscape: 731 x 485 x 125 mm
Dimensions packaged (W x H x D)	869 x 764 x 400 mm
Net weight with stand	24.2 kg
Net weight w/o stand	17.7 kg
Net weight packaged with stand	33.1 kg
Net weight packaged w/o stand	NA
Height adjustment range	96 mm

Tilt	-5° / +25°
Swivel	-30° / +30°
Pivot	NA
Mounting standard	VESA (100 mm)
Screen protection	Protective, non-reflective glass cover
Recommended modalities	CT, MR, US, DR, CR, NM, Film
Certifications	CE0120 (MDD 93/42/EEC class IIb product), CE - 2004/108/EC, CE - 93/42/EEC; A1:2007/47/EC class II b, UL 60601-1 1ST EDITION, CAN/CSA-C22.2 NO. 601.1-M90:2005, IEC 60601-1 2ND ED:1988 + A1:1991 + A2:1995, IEC 60950-1:2005 2ND EDITION, DEMKO - EN 60601-1:1990 + A1:1993 + A2:1995, VCCI, FCC class B, BSMI, FDA 510K, RoHS, KC
Supplied accessories	User Guide Quick-Installation Sheet Video cables (2 x DVI Dual Link, 2 x DisplayPort) Main cables (UK, European (CEBEC/KEMA), USA (UL/CSA; adaptor plug NEMA 5-15P), Chinese (CCC)) USB 2.0 cable External power supply
Optional accessories	NA
QA software	MediCal QAWeb
Unit per pallet	NA
Pallet dimensions	NA
Warranty	5 years
Operating temperature	0°C to 40°C (15°C to 35°C within specs)
Storage temperature	-20°C to 60°C
Operating humidity	8% - 70% (non-condensing)
Storage humidity	5% - 95% (non-condensing)
Operating altitude	2000 m

* In dark reading room conditions (0 lux)

Warranty statement

BARCO MID GENERAL WARRANTY TERMS AND CONDITIONS

Applicable from Jan 1st 2008

ARTICLE 1: PRODUCT WARRANTY

Barco nv, Medical Imaging Division warrants that the equipment will be free of defects in workmanship or material for the warranty period or the specific period of a warranty extension program.

Hardware: Barco warrants that upon delivery hereunder the Products shall (i) conform to its specifications in effect at the date of delivery and (ii) be free from defects in material and workmanship (the "Warranties").

Software: Barco warrants that software written by Barco shall perform substantially in accordance with the specifications in effect at the date of delivery. Software is inherently susceptible to bugs and errors. Barco makes no warranties with respect to the software which is provided to Customer on an "as-is" basis and does not warrant uninterrupted or error-free operation of the Products.

Unless otherwise indicated in Barco's Product manual or in the agreement between Barco and Customer, the Warranty Period shall be

(a) Hardware: 12 months commencing on the Barco date of invoice.

(b) Software: 3 months commencing on the Barco date of invoice.

Notwithstanding the provisions of clause 2, repair and replacement of defects in material and/or workmanship under this warranty shall be accomplished in our works according to the terms and conditions as set forth hereafter:

1.1 Any claim under the Warranties must be notified to Barco in writing within 8 days from the date the defect or failure has been discovered or noticed the first time. The Customer, upon the occurrence of any equipment failure, shall contact Barco nv, MID customer support centre (or an authorised service centre) by telephone, fax or e-mail and shall provide the applicable customer support person with a complete description of the problem being encountered, including the model and serial number of the equipment in which the problem has arisen.

1.2 The customer support person shall diagnose the problem experienced by the Customer and shall advise the Customer on how to proceed. Customer support may ask to return the faulty equipment or faulty subassemblies to the Barco nv, or a MID customer support centre (or an authorised service centre) for repair activities. In no event shall Customer return a defective Product or part thereof to Barco without Barco's prior written approval.

In the event the return to Barco of the defective Product is authorized by Barco, Barco shall issue to Customer an RMA (Return Material Authorization).

The Customer shall apply for an RMA number to the closest Barco nv, MID Customer support centre (or an authorised service centre) as listed at www.barcomedical.com, unless otherwise indicated.

The one-way cost of packing, transport and insurance related to shipping the alleged defective Product or part to Barco for repair or replacement shall be borne by Customer. The one-way cost of packing, transport and insurance related to shipping of the repaired or replacement Product or part to Customer shall be borne by Barco.

1.3 The Customer shall return, freight prepaid, the defective equipment or subassemblies in its original packaging with the assigned RMA number for repair to the Barco nv, MID Customer support centre (or an authorised service centre).

1.4 Replacement parts used shall be new or equivalent to new parts for the revision level of the equipment. A replacement LCD panel will be new or similar run time. The warranty period for the replacement parts will expire at the same moment as the original warranty period of the equipment. All parts replaced hereunder and returned to Barco nv, MID (or an authorised service centre) shall become the property of Barco nv, MID (or the authorised service centre).

1.5 The repaired equipment shall be returned to the Customer, by regular freight, at Barco nv, MID's charge.

1.6 Barco nv, MID will replace a product that fails within 90 days after shipment from Barco with a new one, ensuring color matching in the event of a diagnostic multi head display configuration.

Barco aims to ship the new replacement product within 2 business days after receipt of the Customers notification in writing.

ARTICLE 2: CONDITIONS PRECEDENT FOR WARRANTY AND ITEMS EXCLUDED FROM WARRANTY

- A. The Warranties shall apply only to the extent the Products or any parts thereof have
- (i) been transported and stored at all times in the original packaging in the conditions as specified by Barco (such as covered and secure location, minimum and maximum temperature, maximum humidity, ...) or, in absence thereof, at least in conditions consistent with generally accepted practice for this type of products;
 - (ii) been handled at all times in accordance with Barco's instructions or, in absence thereof, at least with the care and caution consistent with generally accepted practice for this type of products;
 - (iii) been installed strictly in accordance with the instructions and directions given by Barco (if and to the extent the

- Products have not been installed by Barco or its authorized subcontractors);
- (iv) not been subject to any unauthorized access, alteration, modification or repair or attempts thereto;
 - (v) been at all times "normally used" for the intended purpose and operated in strict accordance with the operating instructions set forth in the operating manual of the Product in question and shall not have been otherwise misused, abused, damaged. For the purpose hereof, "normally used" shall mean a regular, ordinary and routine usage of the Product in question as intended and/or recommended by Barco;
 - (vi) been maintained at all times in accordance with Barco's instructions or, in absence thereof, at least with intervals and in a manner consistent with generally accepted practice for this type of products;
- B. The warranty described herein shall not include the following:
- 2.1 Any hardware or software item procured from a source other than Barco nv, MID or their official agent or distributor and integrated by Customer or a third party into Barco nv, MID supplied equipment.
 - 2.2 Any host configuration not explicitly supported by Barco nv, MID.
 - 2.3 All software installed on the system, whether they are acquired from Barco nv, MID or third party. An exception is made for software delivered by Barco nv, MID that would prove to be a cause for the mal functioning of the hardware covered under this Agreement.
 - 2.4 Normal wear and tear, use under circumstances exceeding specifications, such as use in dusty environment or under excessive temperature conditions, abuse, unauthorised repair or alteration, lack of proper configuration or maintenance, damaged or modified or removed serial number, cosmetic refurbishment.
 - 2.5 Repair or replacement of consumables¹ or specific parts that by definition are subject to wear and tear, including but not limited to:
 - a. CRT's, LCD panels
 - b. Backlights in diagnostic LCD displays, when the backlight run time² is beyond the Guaranteed Backlight Lifetime³ of that model, when used at the Factory Calibrated Luminance⁴
 - Eg1.
 - A display is used at 8 hours/day; ie. +/-2.920hours/year
 - The display system is covered with a warranty period of 5 year
 - The Guaranteed Backlight Lifetime of that model is 17.000hours.
 - The Factory Calibrated Luminance cannot be achieved anymore after 4 year, thus corresponding to +/- 11.680hours
 - Result: the backlight replacement is performed under warranty
 - Eg2.
 - A display is used at 24 hours/day; ie. 8.760hours/year
 - The display system is covered with a warranty program of 5 year
 - The Guaranteed Backlight Lifetime of that model is 17.000hours.
 - The Factory Calibrated Luminance cannot be achieved anymore after 2.5years, thus corresponding to +/- 21.900hours
 - Result: the backlight replacement does not make part of the warranty coverage.
 - (1): 'Consumable' is a part that can be replaced by the user
 - (2): 'Backlight run time' is the total time that an image (including use of a screen saver) has been applied to the screen; this value can be consulted via the OSD buttons (On Screen Display).
 - (3): 'Guaranteed Backlight Lifetime' is the number of backlight hours during which a predefined luminance value, ie. the Factory Calibrated Luminance, will be provided by a specific diagnostic display model. This figure is printed on the Warranty certificate of each display or can be requested at your local Barco office.
 - (4): 'Factory Calibrated Luminance': is the typical luminance value that a specific diagnostic display model is calibrated at during the production process. This figure is printed on the Warranty certificate of each display or can be requested at your local Barco office.
 - c. Lamps, optical components in projectors
 - d. Replacement because of:
 - i. image retention as a result of:
 - not correctly using screen saver and/or Display Power Management System (DPMS) as explained in the user manual
 - prolonged operation of the display with a static image on the same screen area
 - ii. a number of missing pixels that is lower than the total allowable number as mentioned in the product specifications.

- iii. difference in color temperature that is lower than the total allowable difference as mentioned in the product specifications
- iv. difference in color temperature as a result of not using all displays of a multi-head configuration at the same rate.
- v. LCD luminance uniformity that is in within the product specifications or luminance uniformity performance that is inherent to LCD technology.

Barco nv, MID does not warrant a minimum life time nor a performance of any of the consumables.

- 2.6 Replacement of moveable parts such as power cords, remote controls, ...
- 2.7 Any product disassembly and installation costs at the operation site, travel expenses and travel time to and from the operation site for the personnel in charge of the repair works and transport charges.
- 2.8 Any failures resulting from an accident, negligence (such as but not limited to removing or deleting system files & licensed software product files), misuse, circuit failure or any change, damage due to fire, water, thunder or lightning, power failure or fluctuation, disruption of communication lines or due to force majeure, or any reason foreign to the equipment.
- 2.9 Any specific services or procedures, asked for by Customer, related to verification of repaired equipment.
- 2.10 The evaluation cost in case of a returned product deemed functional is not covered under warranty and will be charged to the Customer, at Barco's sole discretion, based on a case-by-case evaluation.

ARTICLE 3: OBLIGATIONS OF THE CUSTOMER

Customer hereby assumes the following obligations as partial consideration for Barco nv, MID performance of its requirements under the warranty condition; failure by Customer to meet its obligations under this paragraph shall excuse Barco nv, MID's performance hereunder:

- 3.1 Customer shall not expose Barco nv, MID personnel to any unsafe working conditions.
- 3.2 Repairs to equipment under warranty resulting from improper maintenance or repair performed by the Customer, or its officers, agents, employees, or representatives, shall be borne by the Customer at its additional cost and expense.
- 3.3 The Customer is responsible for installing the Barco nv, MID equipment in an environment for which it was intended. If there is an indication that the equipment was used – even temporary – outside its specifications, Barco nv, MID is entitled not to perform warranty repairs and terminate the warranty agreement. Any actions that have been taken by Barco nv, MID in this respect, may be invoiced to the Customer at normal pricing.

ARTICLE 4: REMEDIES UNDER WARRANTY

- (a) Hardware: If during the Warranty Period a Product or any part thereof, fails to meet any of the Warranties then, upon Customer's request, Barco shall, at its sole option and cost, promptly and within 20 working days, either: (i) repair or correct the Product or part in question; or (ii) replace the Product or supply part(s) or component(s) according to the terms and conditions contained in article 1. A replacement part shall be at least functionally equivalent to the original part. The replaced Product, parts and/or components shall become the property of Barco and shall, at Barco's request, be returned by Customer to Barco at Barco's cost.
- (b) Software: Barco's sole obligation shall be to rectify substantial malfunctions of the software (to the extent technically reasonably possible) by amending the software or supplying an alternative version of the software.
- (c) The repair or replacement under the Warranties covers the cost of material and labor.

ARTICLE 5: DISCLAIMER OF WARRANTIES

BARCO NV, MID DISCLAIMS ALL WARRANTIES, EXPRESSED OR IMPLIED, INCLUDING ALL IMPLIED WARRANTIES OF MERCHANTABILITY AND FITNESS FOR A PARTICULAR PURPOSE.

ARTICLE 6: LIMITATION OF LIABILITY

The remedies specified in these Terms and Conditions shall constitute Customer's sole and exclusive remedy and Barco's sole and exclusive liability for Barco's breach of the Warranties hereunder.

BARCO NV, MID SHALL NOT UNDER ANY CIRCUMSTANCES BE LIABLE TO CUSTOMER OR ANY THIRD PARTY FOR DIRECT, INDIRECT, INCIDENTAL, SPECIAL OR CONSEQUENTIAL DAMAGES, SUCH AS BUT NOT LIMITED TO, DAMAGE TO OR LOSS OF TANGIBLE OR INTANGIBLE PROPERTY OR EQUIPMENT, LOSS OF PROFITS OR REVENUES, COST OF CAPITAL, COST OF PURCHASE OF REPLACEMENT GOODS, OR CLAIMS OF USER FOR SERVICE INTERRUPTIONS. THE LIABILITY OF BARCO NV, MID FOR MANUFACTURING, SALE, DELIVERY, RESALE, INSTALLATION, OPERATION OR SUITABILITY FOR USE OF ANY PRODUCTS OR SERVICES COVERED BY OR FURNISHED UNDER THIS WARRANTY CONDITION, WHETHER ARISING OUT OF CONTRACT, NEGLIGENCE, STRICT TORT, WARRANTY OR OTHERWISE, SHALL NOT EXCEED THE PRICE OF THE ITEM OR ITEMS OF GOODS OR SERVICES UPON WHICH SUCH LIABILITY IS BASED.

ARTICLE 7: FORCE MAJEURE

Either party shall be released from performance of its obligations under this agreement to the extent, and for so long as, the performance of this agreement is impeded by reason of force majeure. For the purposes of this clause the

expression "force majeure" means, but shall not be limited to, industrial dispute, fire, mobilisation, requisition, embargo, currency transfer prohibitions, insurrection, lack of means of transport, restrictions of the use of energy, and generally any circumstances which are beyond the control of the parties and hinder performance by one party of his obligations.

ARTICLE 8: GENERAL

8.1 Customer acknowledges its understanding that all software and electronic devices, including Barco nv, MID products are subject to possible error, mechanical or electrical failure, and should not be relied upon in inappropriate applications or without proper backup and/or other safety precautions whenever personal injury or property damage may result from failure or error of the product.

8.2 Barco nv, MID shall not be responsible for machine failure and/or its failure to render service or maintenance due to causes beyond its reasonable control.

Open source license information

This product contains software components released under an Open Source license. A copy of the source code is available on request by contacting your MID customer support representative at image.careGLOB@barco.com.

The licenses are only provided in English because translations do not legally state the distribution terms for software that uses these licenses - only the original English text does that. However, translations in your local language are available at www.gnu.org.

The software running in the internal processor uses the following licenses.

GNU GENERAL PUBLIC LICENSE, Version 2, June 1991

Copyright (C) 1989, 1991 Free Software Foundation, Inc.

51 Franklin Street, Fifth Floor, Boston, MA 02110-1301 USA

Everyone is permitted to copy and distribute verbatim copies of this license document, but changing it is not allowed.

Preamble

The licenses for most software are designed to take away your freedom to share and change it. By contrast, the GNU General Public License is intended to guarantee your freedom to share and change free software—to make sure the software is free for all its users. This General Public License applies to most of the Free Software Foundation's software and to any other program whose authors commit to using it. (Some other Free Software Foundation software is covered by the GNU Lesser General Public License instead.) You can apply it to your programs, too.

When we speak of free software, we are referring to freedom, not price. Our General Public Licenses are designed to make sure that you have the freedom to distribute copies of free software (and charge for this service if you wish), that you receive source code or can get it if you want it, that you can change the software or use pieces of it in new free programs; and that you know you can do these things.

To protect your rights, we need to make restrictions that forbid anyone to deny you these rights or to ask you to surrender the rights. These restrictions translate to certain responsibilities for you if you distribute copies of the software, or if you modify it.

For example, if you distribute copies of such a program, whether gratis or for a fee, you must give the recipients all the rights that you have. You must make sure that they, too, receive or can get the source code. And you must show them these terms so they know their rights.

We protect your rights with two steps: (1) copyright the software, and (2) offer you this license which gives you legal permission to copy, distribute and/or modify the software.

Also, for each author's protection and ours, we want to make certain that everyone understands that there is no warranty for this free software. If the software is modified by someone else and passed on, we want its recipients to know that what they have is not the original, so that any problems introduced by others will not reflect on the original authors' reputations.

Finally, any free program is threatened constantly by software patents. We wish to avoid the danger that redistributors of a free program will individually obtain patent licenses, in effect making the program proprietary. To prevent this, we have made it clear that any patent must be licensed for everyone's free use or not licensed at all.

The precise terms and conditions for copying, distribution and modification follow.

GNU GENERAL PUBLIC LICENSE

TERMS AND CONDITIONS FOR COPYING, DISTRIBUTION AND MODIFICATION

0. This License applies to any program or other work which contains a notice placed by the copyright holder saying it may be distributed under the terms of this General Public License. The "Program", below, refers to any such program or

work, and a "work based on the Program" means either the Program or any derivative work under copyright law: that is to say, a work containing the Program or a portion of it, either verbatim or with modifications and/or translated into another language. (Hereinafter, translation is included without limitation in the term "modification".) Each licensee is addressed as "you".

Activities other than copying, distribution and modification are not covered by this License; they are outside its scope. The act of running the Program is not restricted, and the output from the Program is covered only if its contents constitute a work based on the Program (independent of having been made by running the Program). Whether that is true depends on what the Program does.

1. You may copy and distribute verbatim copies of the Program's source code as you receive it, in any medium, provided that you conspicuously and appropriately publish on each copy an appropriate copyright notice and disclaimer of warranty; keep intact all the notices that refer to this License and to the absence of any warranty; and give any other recipients of the Program a copy of this License along with the Program.

You may charge a fee for the physical act of transferring a copy, and you may at your option offer warranty protection in exchange for a fee.

2. You may modify your copy or copies of the Program or any portion of it, thus forming a work based on the Program, and copy and distribute such modifications or work under the terms of Section 1 above, provided that you also meet all of these conditions:

- a) You must cause the modified files to carry prominent notices stating that you changed the files and the date of any change.
- b) You must cause any work that you distribute or publish, that in whole or in part contains or is derived from the Program or any part thereof, to be licensed as a whole at no charge to all third parties under the terms of this License.
- c) If the modified program normally reads commands interactively when run, you must cause it, when started running for such interactive use in the most ordinary way, to print or display an announcement including an appropriate copyright notice and a notice that there is no warranty (or else, saying that you provide a warranty) and that users may redistribute the program under these conditions, and telling the user how to view a copy of this License. (Exception: if the Program itself is interactive but does not normally print such an announcement, your work based on the Program is not required to print an announcement.)

These requirements apply to the modified work as a whole. If identifiable sections of that work are not derived from the Program, and can be reasonably considered independent and separate works in themselves, then this License, and its terms, do not apply to those sections when you distribute them as separate works. But when you distribute the same sections as part of a whole which is a work based on the Program, the distribution of the whole must be on the terms of this License, whose permissions for other licensees extend to the entire whole, and thus to each and every part regardless of who wrote it.

Thus, it is not the intent of this section to claim rights or contest your rights to work written entirely by you; rather, the intent is to exercise the right to control the distribution of derivative or collective works based on the Program.

In addition, mere aggregation of another work not based on the Program with the Program (or with a work based on the Program) on a volume of a storage or distribution medium does not bring the other work under the scope of this License.

3. You may copy and distribute the Program (or a work based on it, under Section 2) in object code or executable form under the terms of Sections 1 and 2 above provided that you also do one of the following:

- a) Accompany it with the complete corresponding machine-readable source code, which must be distributed under the terms of Sections 1 and 2 above on a medium customarily used for software interchange; or,
- b) Accompany it with a written offer, valid for at least three years, to give any third party, for a charge no more than your cost of physically performing source distribution, a complete machine-readable copy of the corresponding source code, to be distributed under the terms of Sections 1 and 2 above on a medium customarily used for software interchange; or,
- c) Accompany it with the information you received as to the offer to distribute corresponding source code. (This alternative is allowed only for noncommercial distribution and only if you received the program in object code or executable form with such an offer, in accord with Subsection b above.)

The source code for a work means the preferred form of the work for making modifications to it. For an executable work, complete source code means all the source code for all modules it contains, plus any associated interface definition files, plus the scripts used to control compilation and installation of the executable. However, as a special exception, the source code distributed need not include anything that is normally distributed (in either source or binary form) with the major components (compiler, kernel, and so on) of the operating system on which the executable runs, unless that component itself accompanies the executable.

If distribution of executable or object code is made by offering access to copy from a designated place, then offering equivalent access to copy the source code from the same place counts as distribution of the source code, even though third parties are not compelled to copy the source along with the object code.

4. You may not copy, modify, sublicense, or distribute the Program except as expressly provided under this License. Any attempt otherwise to copy, modify, sublicense or distribute the Program is void, and will automatically terminate your rights under this License. However, parties who have received copies, or rights, from you under this License will not

have their licenses terminated so long as such parties remain in full compliance.

5. You are not required to accept this License, since you have not signed it. However, nothing else grants you permission to modify or distribute the Program or its derivative works. These actions are prohibited by law if you do not accept this License. Therefore, by modifying or distributing the Program (or any work based on the Program), you indicate your acceptance of this License to do so, and all its terms and conditions for copying, distributing or modifying the Program or works based on it.

6. Each time you redistribute the Program (or any work based on the Program), the recipient automatically receives a license from the original licensor to copy, distribute or modify the Program subject to these terms and conditions. You may not impose any further restrictions on the recipients' exercise of the rights granted herein. You are not responsible for enforcing compliance by third parties to this License.

7. If, as a consequence of a court judgment or allegation of patent infringement or for any other reason (not limited to patent issues), conditions are imposed on you (whether by court order, agreement or otherwise) that contradict the conditions of this License, they do not excuse you from the conditions of this License. If you cannot distribute so as to satisfy simultaneously your obligations under this License and any other pertinent obligations, then as a consequence you may not distribute the Program at all. For example, if a patent license would not permit royalty-free redistribution of the Program by all those who receive copies directly or indirectly through you, then the only way you could satisfy both it and this license would be to refrain entirely from distribution of the Program.

If any portion of this section is held invalid or unenforceable under any particular circumstance, the balance of the section is intended to apply and the section as a whole is intended to apply in other circumstances.

It is not the purpose of this section to induce you to infringe any patents or other property right claims or to contest validity of any such claims; this section has the sole purpose of protecting the integrity of the free software distribution system, which is implemented by public license practices. Many people have made generous contributions to the wide range of software distributed through that system in reliance on consistent application of that system; it is up to the author/donor to decide if he or she is willing to distribute software through any other system and a licensee cannot impose that choice.

This section is intended to make thoroughly clear what is believed to be a consequence of the rest of this License.

8. If the distribution and/or use of the Program is restricted in certain countries either by patents or by copyrighted interfaces, the original copyright holder who places the Program under this License may add an explicit geographical distribution limitation excluding those countries, so that distribution is permitted only in or among countries not thus excluded. In such case, this License incorporates the limitation as if written in the body of this License.

9. The Free Software Foundation may publish revised and/or new versions of the General Public License from time to time. Such new versions will be similar in spirit to the present version, but may differ in detail to address new problems or concerns.

Each version is given a distinguishing version number. If the Program specifies a version number of this License which applies to it and "any later version", you have the option of following the terms and conditions either of that version or of any later version published by the Free Software Foundation. If the Program does not specify a version number of this License, you may choose any version ever published by the Free Software Foundation.

10. If you wish to incorporate parts of the Program into other free programs whose distribution conditions are different, write to the author to ask for permission. For software which is copyrighted by the Free Software Foundation, write to the Free Software Foundation; we sometimes make exceptions for this. Our decision will be guided by the two goals of preserving the free status of all derivatives of our free software and of promoting the sharing and reuse of software generally.

NO WARRANTY

11. BECAUSE THE PROGRAM IS LICENSED FREE OF CHARGE, THERE IS NO WARRANTY FOR THE PROGRAM, TO THE EXTENT PERMITTED BY APPLICABLE LAW. EXCEPT WHEN

OTHERWISE STATED IN WRITING THE COPYRIGHT HOLDERS AND/OR OTHER PARTIES PROVIDE THE PROGRAM "AS IS" WITHOUT WARRANTY OF ANY KIND, EITHER EXPRESSED OR IMPLIED, INCLUDING, BUT NOT LIMITED TO, THE IMPLIED WARRANTIES OF MERCHANTABILITY AND FITNESS FOR A PARTICULAR PURPOSE. THE ENTIRE RISK AS TO THE QUALITY AND PERFORMANCE OF THE PROGRAM IS WITH YOU. SHOULD THE PROGRAM PROVE DEFECTIVE, YOU ASSUME THE COST OF ALL NECESSARY SERVICING, REPAIR OR CORRECTION.

12. IN NO EVENT UNLESS REQUIRED BY APPLICABLE LAW OR AGREED TO IN WRITING WILL ANY COPYRIGHT HOLDER, OR ANY OTHER PARTY WHO MAY MODIFY AND/OR

REDISTRIBUTE THE PROGRAM AS PERMITTED ABOVE, BE LIABLE TO YOU FOR DAMAGES, INCLUDING ANY GENERAL, SPECIAL, INCIDENTAL OR CONSEQUENTIAL DAMAGES ARISING OUT OF THE USE OR INABILITY TO USE THE PROGRAM (INCLUDING BUT NOT LIMITED TO LOSS OF DATA OR DATA BEING RENDERED INACCURATE OR LOSSES SUSTAINED BY YOU OR THIRD PARTIES OR A FAILURE OF THE PROGRAM TO OPERATE WITH ANY OTHER PROGRAMS), EVEN IF SUCH HOLDER OR OTHER PARTY HAS BEEN ADVISED OF THE POSSIBILITY OF SUCH DAMAGES.

END OF TERMS AND CONDITIONS

GNU GENERAL PUBLIC LICENSE, Version 3, 29 June 2007

Copyright (C) 2007 Free Software Foundation, Inc. <<http://fsf.org/>>

Everyone is permitted to copy and distribute verbatim copies of this license document, but changing it is not allowed.

Preamble

The GNU General Public License is a free, copyleft license for software and other kinds of works.

The licenses for most software and other practical works are designed to take away your freedom to share and change the works. By contrast, the GNU General Public License is intended to guarantee your freedom to share and change all versions of a program--to make sure it remains free software for all its users. We, the Free Software Foundation, use the GNU General Public License for most of our software; it applies also to any other work released this way by its authors. You can apply it to your programs, too.

When we speak of free software, we are referring to freedom, not price. Our General Public Licenses are designed to make sure that you have the freedom to distribute copies of free software (and charge for them if you wish), that you receive source code or can get it if you want it, that you can change the software or use pieces of it in new free programs, and that you know you can do these things.

To protect your rights, we need to prevent others from denying you these rights or asking you to surrender the rights. Therefore, you have certain responsibilities if you distribute copies of the software, or if you modify it: responsibilities to respect the freedom of others.

For example, if you distribute copies of such a program, whether gratis or for a fee, you must pass on to the recipients the same freedoms that you received. You must make sure that they, too, receive or can get the source code. And you must show them these terms so they know their rights.

Developers that use the GNU GPL protect your rights with two steps: (1) assert copyright on the software, and (2) offer you this License giving you legal permission to copy, distribute and/or modify it.

For the developers' and authors' protection, the GPL clearly explains that there is no warranty for this free software. For both users' and authors' sake, the GPL requires that modified versions be marked as changed, so that their problems will not be attributed erroneously to authors of previous versions.

Some devices are designed to deny users access to install or run modified versions of the software inside them, although the manufacturer can do so. This is fundamentally incompatible with the aim of protecting users' freedom to change the software. The systematic pattern of such abuse occurs in the area of products for individuals to use, which is precisely where it is most unacceptable. Therefore, we have designed this version of the GPL to prohibit the practice for those products. If such problems arise substantially in other domains, we stand ready to extend this provision to those domains in future versions of the GPL, as needed to protect the freedom of users.

Finally, every program is threatened constantly by software patents. States should not allow patents to restrict development and use of software on general-purpose computers, but in those that do, we wish to avoid the special danger that patents applied to a free program could make it effectively proprietary. To prevent this, the GPL assures that patents cannot be used to render the program non-free.

The precise terms and conditions for copying, distribution and modification follow.

TERMS AND CONDITIONS

0. Definitions.

"This License" refers to version 3 of the GNU General Public License.

"Copyright" also means copyright-like laws that apply to other kinds of works, such as semiconductor masks.

"The Program" refers to any copyrightable work licensed under this License. Each licensee is addressed as "you".

"Licensees" and "recipients" may be individuals or organizations.

To "modify" a work means to copy from or adapt all or part of the work in a fashion requiring copyright permission, other than the making of an exact copy. The resulting work is called a "modified version" of the earlier work or a work "based on" the earlier work.

A "covered work" means either the unmodified Program or a work based on the Program.

To "propagate" a work means to do anything with it that, without permission, would make you directly or secondarily liable for infringement under applicable copyright law, except executing it on a computer or modifying a private copy. Propagation includes copying, distribution (with or without modification), making available to the public, and in some countries other activities as well.

To "convey" a work means any kind of propagation that enables other parties to make or receive copies. Mere interaction with a user through a computer network, with no transfer of a copy, is not conveying.

An interactive user interface displays "Appropriate Legal Notices" to the extent that it includes a convenient and prominently visible feature that (1) displays an appropriate copyright notice, and (2) tells the user that there is no warranty for the work (except to the extent that warranties are provided), that licensees may convey the work under this License, and how to view a copy of this License. If the interface presents a list of user commands or options, such as a menu, a prominent item in the list meets this criterion.

1. Source Code.

The "source code" for a work means the preferred form of the work for making modifications to it. "Object code" means any non-source form of a work.

A "Standard Interface" means an interface that either is an official standard defined by a recognized standards body, or, in the case of interfaces specified for a particular programming language, one that is widely used among developers working in that language.

The "System Libraries" of an executable work include anything, other than the work as a whole, that (a) is included in the normal form of packaging a Major Component, but which is not part of that Major Component, and (b) serves only to enable use of the work with that Major Component, or to implement a Standard Interface for which an implementation is available to the public in source code form. A "Major Component", in this context, means a major essential component (kernel, window system, and so on) of the specific operating system (if any) on which the executable work runs, or a compiler used to produce the work, or an object code interpreter used to run it.

The "Corresponding Source" for a work in object code form means all the source code needed to generate, install, and (for an executable work) run the object code and to modify the work, including scripts to control those activities. However, it does not include the work's System Libraries, or general-purpose tools or generally available free programs which are used unmodified in performing those activities but which are not part of the work. For example, Corresponding Source includes interface definition files associated with source files for the work, and the source code for shared libraries and dynamically linked subprograms that the work is specifically designed to require, such as by intimate data communication or control flow between those subprograms and other parts of the work.

The Corresponding Source need not include anything that users can regenerate automatically from other parts of the Corresponding Source.

The Corresponding Source for a work in source code form is that same work.

2. Basic Permissions.

All rights granted under this License are granted for the term of copyright on the Program, and are irrevocable provided the stated conditions are met. This License explicitly affirms your unlimited permission to run the unmodified Program. The output from running a covered work is covered by this License only if the output, given its content, constitutes a covered work. This License acknowledges your rights of fair use or other equivalent, as provided by copyright law.

You may make, run and propagate covered works that you do not convey, without conditions so long as your license otherwise remains in force. You may convey covered works to others for the sole purpose of having them make modifications exclusively for you, or provide you with facilities for running those works, provided that you comply with the terms of this License in conveying all material for which you do not control copyright. Those thus making or running the covered works for you must do so exclusively on your behalf, under your direction and control, on terms that prohibit them from making any copies of your copyrighted material outside their relationship with you.

Conveying under any other circumstances is permitted solely under the conditions stated below. Sublicensing is not allowed; section 10 makes it unnecessary.

3. Protecting Users' Legal Rights From Anti-Circumvention Law.

No covered work shall be deemed part of an effective technological measure under any applicable law fulfilling obligations under article 11 of the WIPO copyright treaty adopted on 20 December 1996, or similar laws prohibiting or restricting circumvention of such measures.

When you convey a covered work, you waive any legal power to forbid circumvention of technological measures to the extent such circumvention is effected by exercising rights under this License with respect to the covered work, and you disclaim any intention to limit operation or modification of the work as a means of enforcing, against the work's users, your or third parties' legal rights to forbid circumvention of technological measures.

4. Conveying Verbatim Copies.

You may convey verbatim copies of the Program's source code as you receive it, in any medium, provided that you conspicuously and appropriately publish on each copy an appropriate copyright notice; keep intact all notices stating that this License and any non-permissive terms added in accord with section 7 apply to the code; keep intact all notices of the absence of any warranty; and give all recipients a copy of this License along with the Program.

You may charge any price or no price for each copy that you convey, and you may offer support or warranty protection for a fee.

5. Conveying Modified Source Versions.

You may convey a work based on the Program, or the modifications to produce it from the Program, in the form of source code under the terms of section 4, provided that you also meet all of these conditions:

- The work must carry prominent notices stating that you modified it, and giving a relevant date.
- The work must carry prominent notices stating that it is released under this License and any conditions added under section 7. This requirement modifies the requirement in section 4 to "keep intact all notices".
- You must license the entire work, as a whole, under this License to anyone who comes into possession of a copy. This license will therefore apply, along with any applicable section 7 additional terms, to the whole of the work, and all its parts, regardless of how they are packaged. This License gives no permission to license the work in any other way, but it does not invalidate such permission if you have separately received it.

- d) If the work has interactive user interfaces, each must display Appropriate Legal Notices; however, if the Program has interactive interfaces that do not display Appropriate Legal Notices, your work need not make them do so.

A compilation of a covered work with other separate and independent works, which are not by their nature extensions of the covered work, and which are not combined with it such as to form a larger program, in or on a volume of a storage or distribution medium, is called an "aggregate" if the compilation and its resulting copyright are not used to limit the access or legal rights of the compilation's users beyond what the individual works permit. Inclusion of a covered work in an aggregate does not cause this License to apply to the other parts of the aggregate.

6. Conveying Non-Source Forms.

You may convey a covered work in object code form under the terms of sections 4 and 5, provided that you also convey the machine-readable Corresponding Source under the terms of this License, in one of these ways:

- a) Convey the object code in, or embodied in, a physical product (including a physical distribution medium), accompanied by the Corresponding Source fixed on a durable physical medium customarily used for software interchange.
- b) Convey the object code in, or embodied in, a physical product (including a physical distribution medium), accompanied by a written offer, valid for at least three years and valid for as long as you offer spare parts or customer support for that product model, to give anyone who possesses the object code either (1) a copy of the Corresponding Source for all the software in the product that is covered by this License, on a durable physical medium customarily used for software interchange, for a price no more than your reasonable cost of physically performing this conveying of source, or (2) access to copy the Corresponding Source from a network server at no charge.
- c) Convey individual copies of the object code with a copy of the written offer to provide the Corresponding Source. This alternative is allowed only occasionally and noncommercially, and only if you received the object code with such an offer, in accord with subsection 6b.
- d) Convey the object code by offering access from a designated place (gratis or for a charge), and offer equivalent access to the Corresponding Source in the same way through the same place at no further charge. You need not require recipients to copy the Corresponding Source along with the object code. If the place to copy the object code is a network server, the Corresponding Source may be on a different server (operated by you or a third party) that supports equivalent copying facilities, provided you maintain clear directions next to the object code saying where to find the Corresponding Source. Regardless of what server hosts the Corresponding Source, you remain obligated to ensure that it is available for as long as needed to satisfy these requirements.
- e) Convey the object code using peer-to-peer transmission, provided you inform other peers where the object code and Corresponding Source of the work are being offered to the general public at no charge under subsection 6d.

A separable portion of the object code, whose source code is excluded from the Corresponding Source as a System Library, need not be included in conveying the object code work.

A "User Product" is either (1) a "consumer product", which means any tangible personal property which is normally used for personal, family, or household purposes, or (2) anything designed or sold for incorporation into a dwelling. In determining whether a product is a consumer product, doubtful cases shall be resolved in favor of coverage. For a particular product received by a particular user, "normally used" refers to a typical or common use of that class of product, regardless of the status of the particular user or of the way in which the particular user actually uses, or expects or is expected to use, the product. A product is a consumer product regardless of whether the product has substantial commercial, industrial or non-consumer uses, unless such uses represent the only significant mode of use of the product.

"Installation Information" for a User Product means any methods, procedures, authorization keys, or other information required to install and execute modified versions of a covered work in that User Product from a modified version of its Corresponding Source. The information must suffice to ensure that the continued functioning of the modified object code is in no case prevented or interfered with solely because modification has been made.

If you convey an object code work under this section in, or with, or specifically for use in, a User Product, and the conveying occurs as part of a transaction in which the right of possession and use of the User Product is transferred to the recipient in perpetuity or for a fixed term (regardless of how the transaction is characterized), the Corresponding Source conveyed under this section must be accompanied by the Installation Information. But this requirement does not apply if neither you nor any third party retains the ability to install modified object code on the User Product (for example, the work has been installed in ROM).

The requirement to provide Installation Information does not include a requirement to continue to provide support service, warranty, or updates for a work that has been modified or installed by the recipient, or for the User Product in which it has been modified or installed. Access to a network may be denied when the modification itself materially and adversely affects the operation of the network or violates the rules and protocols for communication across the network.

Corresponding Source conveyed, and Installation Information provided, in accord with this section must be in a format that is publicly documented (and with an implementation available to the public in source code form), and must require no special password or key for unpacking, reading or copying.

7. Additional Terms.

"Additional permissions" are terms that supplement the terms of this License by making exceptions from one or more of its conditions. Additional permissions that are applicable to the entire Program shall be treated as though they were

included in this License, to the extent that they are valid under applicable law. If additional permissions apply only to part of the Program, that part may be used separately under those permissions, but the entire Program remains governed by this License without regard to the additional permissions.

When you convey a copy of a covered work, you may at your option remove any additional permissions from that copy, or from any part of it. (Additional permissions may be written to require their own removal in certain cases when you modify the work.) You may place additional permissions on material, added by you to a covered work, for which you have or can give appropriate copyright permission.

Notwithstanding any other provision of this License, for material you add to a covered work, you may (if authorized by the copyright holders of that material) supplement the terms of this License with terms:

- a) Disclaiming warranty or limiting liability differently from the terms of sections 15 and 16 of this License; or
- b) Requiring preservation of specified reasonable legal notices or author attributions in that material or in the Appropriate Legal Notices displayed by works containing it; or
- c) Prohibiting misrepresentation of the origin of that material, or requiring that modified versions of such material be marked in reasonable ways as different from the original version; or
- d) Limiting the use for publicity purposes of names of licensors or authors of the material; or
- e) Declining to grant rights under trademark law for use of some trade names, trademarks, or service marks; or
- f) Requiring indemnification of licensors and authors of that material by anyone who conveys the material (or modified versions of it) with contractual assumptions of liability to the recipient, for any liability that these contractual assumptions directly impose on those licensors and authors.

All other non-permissive additional terms are considered "further restrictions" within the meaning of section 10. If the Program as you received it, or any part of it, contains a notice stating that it is governed by this License along with a term that is a further restriction, you may remove that term. If a license document contains a further restriction but permits relicensing or conveying under this License, you may add to a covered work material governed by the terms of that license document, provided that the further restriction does not survive such relicensing or conveying.

If you add terms to a covered work in accord with this section, you must place, in the relevant source files, a statement of the additional terms that apply to those files, or a notice indicating where to find the applicable files.

Additional terms, permissive or non-permissive, may be stated in the form of a separately written license, or stated as exceptions; the above requirements apply either way.

8. Termination.

You may not propagate or modify a covered work except as expressly provided under this License. Any attempt otherwise to propagate or modify it is void, and will automatically terminate your rights under this License (including any patent licenses granted under the third paragraph of section 11).

However, if you cease all violation of this License, then your license from a particular copyright holder is reinstated (a) provisionally, unless and until the copyright holder explicitly and finally terminates your license, and (b) permanently, if the copyright holder fails to notify you of the violation by some reasonable means prior to 60 days after the cessation.

Moreover, your license from a particular copyright holder is reinstated permanently if the copyright holder notifies you of the violation by some reasonable means, this is the first time you have received notice of violation of this License (for any work) from that copyright holder, and you cure the violation prior to 30 days after your receipt of the notice.

Termination of your rights under this section does not terminate the licenses of parties who have received copies or rights from you under this License. If your rights have been terminated and not permanently reinstated, you do not qualify to receive new licenses for the same material under section 10.

9. Acceptance Not Required for Having Copies.

You are not required to accept this License in order to receive or run a copy of the Program. Ancillary propagation of a covered work occurring solely as a consequence of using peer-to-peer transmission to receive a copy likewise does not require acceptance. However, nothing other than this License grants you permission to propagate or modify any covered work. These actions infringe copyright if you do not accept this License. Therefore, by modifying or propagating a covered work, you indicate your acceptance of this License to do so.

10. Automatic Licensing of Downstream Recipients.

Each time you convey a covered work, the recipient automatically receives a license from the original licensors, to run, modify and propagate that work, subject to this License. You are not responsible for enforcing compliance by third parties with this License.

An "entity transaction" is a transaction transferring control of an organization, or substantially all assets of one, or subdividing an organization, or merging organizations. If propagation of a covered work results from an entity transaction, each party to that transaction who receives a copy of the work also receives whatever licenses to the work the party's predecessor in interest had or could give under the previous paragraph, plus a right to possession of the Corresponding Source of the work from the predecessor in interest, if the predecessor has it or can get it with reasonable efforts.

You may not impose any further restrictions on the exercise of the rights granted or affirmed under this License. For example, you may not impose a license fee, royalty, or other charge for exercise of rights granted under this License, and

you may not initiate litigation (including a cross-claim or counterclaim in a lawsuit) alleging that any patent claim is infringed by making, using, selling, offering for sale, or importing the Program or any portion of it.

11. Patents.

A "contributor" is a copyright holder who authorizes use under this License of the Program or a work on which the Program is based. The work thus licensed is called the contributor's "contributor version".

A contributor's "essential patent claims" are all patent claims owned or controlled by the contributor, whether already acquired or hereafter acquired, that would be infringed by some manner, permitted by this License, of making, using, or selling its contributor version, but do not include claims that would be infringed only as a consequence of further modification of the contributor version. For purposes of this definition, "control" includes the right to grant patent sublicenses in a manner consistent with the requirements of this License.

Each contributor grants you a non-exclusive, worldwide, royalty-free patent license under the contributor's essential patent claims, to make, use, sell, offer for sale, import and otherwise run, modify and propagate the contents of its contributor version.

In the following three paragraphs, a "patent license" is any express agreement or commitment, however denominated, not to enforce a patent (such as an express permission to practice a patent or covenant not to sue for patent infringement). To "grant" such a patent license to a party means to make such an agreement or commitment not to enforce a patent against the party.

If you convey a covered work, knowingly relying on a patent license, and the Corresponding Source of the work is not available for anyone to copy, free of charge and under the terms of this License, through a publicly available network server or other readily accessible means, then you must either (1) cause the Corresponding Source to be so available, or (2) arrange to deprive yourself of the benefit of the patent license for this particular work, or (3) arrange, in a manner consistent with the requirements of this License, to extend the patent license to downstream recipients. "Knowingly relying" means you have actual knowledge that, but for the patent license, your conveying the covered work in a country, or your recipient's use of the covered work in a country, would infringe one or more identifiable patents in that country that you have reason to believe are valid.

If, pursuant to or in connection with a single transaction or arrangement, you convey, or propagate by procuring conveyance of, a covered work, and grant a patent license to some of the parties receiving the covered work authorizing them to use, propagate, modify or convey a specific copy of the covered work, then the patent license you grant is automatically extended to all recipients of the covered work and works based on it.

A patent license is "discriminatory" if it does not include within the scope of its coverage, prohibits the exercise of, or is conditioned on the non-exercise of one or more of the rights that are specifically granted under this License. You may not convey a covered work if you are a party to an arrangement with a third party that is in the business of distributing software, under which you make payment to the third party based on the extent of your activity of conveying the work, and under which the third party grants, to any of the parties who would receive the covered work from you, a discriminatory patent license (a) in connection with copies of the covered work conveyed by you (or copies made from those copies), or (b) primarily for and in connection with specific products or compilations that contain the covered work, unless you entered into that arrangement, or that patent license was granted, prior to 28 March 2007.

Nothing in this License shall be construed as excluding or limiting any implied license or other defenses to infringement that may otherwise be available to you under applicable patent law.

12. No Surrender of Others' Freedom.

If conditions are imposed on you (whether by court order, agreement or otherwise) that contradict the conditions of this License, they do not excuse you from the conditions of this License. If you cannot convey a covered work so as to satisfy simultaneously your obligations under this License and any other pertinent obligations, then as a consequence you may not convey it at all. For example, if you agree to terms that obligate you to collect a royalty for further conveying from those to whom you convey the Program, the only way you could satisfy both those terms and this License would be to refrain entirely from conveying the Program.

13. Use with the GNU Affero General Public License.

Notwithstanding any other provision of this License, you have permission to link or combine any covered work with a work licensed under version 3 of the GNU Affero General Public License into a single combined work, and to convey the resulting work. The terms of this License will continue to apply to the part which is the covered work, but the special requirements of the GNU Affero General Public License, section 13, concerning interaction through a network will apply to the combination as such.

14. Revised Versions of this License.

The Free Software Foundation may publish revised and/or new versions of the GNU General Public License from time to time. Such new versions will be similar in spirit to the present version, but may differ in detail to address new problems or concerns.

Each version is given a distinguishing version number. If the Program specifies that a certain numbered version of the GNU General Public License "or any later version" applies to it, you have the option of following the terms and conditions either of that numbered version or of any later version published by the Free Software Foundation. If the Program does not specify a version number of the GNU General Public License, you may choose any version ever published by the Free Software Foundation.

If the Program specifies that a proxy can decide which future versions of the GNU General Public License can be used, that proxy's public statement of acceptance of a version permanently authorizes you to choose that version for the Program.

Later license versions may give you additional or different permissions. However, no additional obligations are imposed on any author or copyright holder as a result of your choosing to follow a later version.

15. Disclaimer of Warranty.

THERE IS NO WARRANTY FOR THE PROGRAM, TO THE EXTENT PERMITTED BY APPLICABLE LAW. EXCEPT WHEN OTHERWISE STATED IN WRITING THE COPYRIGHT HOLDERS AND/OR OTHER PARTIES PROVIDE THE PROGRAM "AS IS" WITHOUT WARRANTY OF ANY KIND, EITHER EXPRESSED OR IMPLIED, INCLUDING, BUT NOT LIMITED TO, THE IMPLIED WARRANTIES OF MERCHANTABILITY AND FITNESS FOR A PARTICULAR PURPOSE. THE ENTIRE RISK AS TO THE QUALITY AND PERFORMANCE OF THE PROGRAM IS WITH YOU. SHOULD THE PROGRAM PROVE DEFECTIVE, YOU ASSUME THE COST OF ALL NECESSARY SERVICING, REPAIR OR CORRECTION.

16. Limitation of Liability.

IN NO EVENT UNLESS REQUIRED BY APPLICABLE LAW OR AGREED TO IN WRITING WILL ANY COPYRIGHT HOLDER, OR ANY OTHER PARTY WHO MODIFIES AND/OR CONVEYS THE PROGRAM AS PERMITTED ABOVE, BE LIABLE TO YOU FOR DAMAGES, INCLUDING ANY GENERAL, SPECIAL, INCIDENTAL OR CONSEQUENTIAL DAMAGES ARISING OUT OF THE USE OR INABILITY TO USE THE PROGRAM (INCLUDING BUT NOT LIMITED TO LOSS OF DATA OR DATA BEING RENDERED INACCURATE OR LOSSES SUSTAINED BY YOU OR THIRD PARTIES OR A FAILURE OF THE PROGRAM TO OPERATE WITH ANY OTHER PROGRAMS), EVEN IF SUCH HOLDER OR OTHER PARTY HAS BEEN ADVISED OF THE POSSIBILITY OF SUCH DAMAGES.

17. Interpretation of Sections 15 and 16.

If the disclaimer of warranty and limitation of liability provided above cannot be given local legal effect according to their terms, reviewing courts shall apply local law that most closely approximates an absolute waiver of all civil liability in connection with the Program, unless a warranty or assumption of liability accompanies a copy of the Program in return for a fee.

END OF TERMS AND CONDITIONS

GNU LESSER GENERAL PUBLIC LICENSE, Version 2.1, February 1999

Copyright (C) 1991, 1999 Free Software Foundation, Inc.

51 Franklin Street, Fifth Floor, Boston, MA 02110-1301 USA

Everyone is permitted to copy and distribute verbatim copies of this license document, but changing it is not allowed.

[This is the first released version of the Lesser GPL. It also counts as the successor of the GNU Library Public License, version 2, hence the version number 2.1.]

Preamble

The licenses for most software are designed to take away your freedom to share and change it. By contrast, the GNU General Public Licenses are intended to guarantee your freedom to share and change free software--to make sure the software is free for all its users.

This license, the Lesser General Public License, applies to some specially designated software packages--typically libraries--of the Free Software Foundation and other authors who decide to use it. You can use it too, but we suggest you first think carefully about whether this license or the ordinary General Public License is the better strategy to use in any particular case, based on the explanations below.

When we speak of free software, we are referring to freedom of use, not price. Our General Public Licenses are designed to make sure that you have the freedom to distribute copies of free software (and charge for this service if you wish); that you receive source code or can get it if you want it; that you can change the software and use pieces of it in new free programs; and that you are informed that you can do these things.

To protect your rights, we need to make restrictions that forbid distributors to deny you these rights or to ask you to surrender these rights. These restrictions translate to certain responsibilities for you if you distribute copies of the library or if you modify it.

For example, if you distribute copies of the library, whether gratis or for a fee, you must give the recipients all the rights that we gave you. You must make sure that they, too, receive or can get the source code. If you link other code with the library, you must provide complete object files to the recipients, so that they can relink them with the library after making changes to the library and recompiling it. And you must show them these terms so they know their rights.

We protect your rights with a two-step method: (1) we copyright the library, and (2) we offer you this license, which gives you legal permission to copy, distribute and/or modify the library.

To protect each distributor, we want to make it very clear that there is no warranty for the free library. Also, if the library is modified by someone else and passed on, the recipients should know that what they have is not the original version, so that the original author's reputation will not be affected by problems that might be introduced by others.

Finally, software patents pose a constant threat to the existence of any free program. We wish to make sure that a company cannot effectively restrict the users of a free program by obtaining a restrictive license from a patent holder.

Therefore, we insist that any patent license obtained for a version of the library must be consistent with the full freedom of use specified in this license.

Most GNU software, including some libraries, is covered by the ordinary GNU General Public License. This license, the GNU Lesser General Public License, applies to certain designated libraries, and is quite different from the ordinary General Public License. We use this license for certain libraries in order to permit linking those libraries into non-free programs.

When a program is linked with a library, whether statically or using a shared library, the combination of the two is legally speaking a combined work, a derivative of the original library. The ordinary General Public License therefore permits such linking only if the entire combination fits its criteria of freedom. The Lesser General Public License permits more lax criteria for linking other code with the library.

We call this license the "Lesser" General Public License because it does Less to protect the user's freedom than the ordinary General Public License. It also provides other free software developers Less of an advantage over competing non-free programs. These disadvantages are the reason we use the ordinary General Public License for many libraries. However, the Lesser license provides advantages in certain special circumstances.

For example, on rare occasions, there may be a special need to encourage the widest possible use of a certain library, so that it becomes a de-facto standard. To achieve this, non-free programs must be allowed to use the library. A more frequent case is that a free library does the same job as widely used non-free libraries. In this case, there is little to gain by limiting the free library to free software only, so we use the Lesser General Public License.

In other cases, permission to use a particular library in non-free programs enables a greater number of people to use a large body of free software. For example, permission to use the GNU C Library in non-free programs enables many more people to use the whole GNU operating system, as well as its variant, the GNU/Linux operating system.

Although the Lesser General Public License is Less protective of the users' freedom, it does ensure that the user of a program that is linked with the Library has the freedom and the wherewithal to run that program using a modified version of the Library.

The precise terms and conditions for copying, distribution and modification follow. Pay close attention to the difference between a "work based on the library" and a "work that uses the library". The former contains code derived from the library, whereas the latter must be combined with the library in order to run.

GNU LESSER GENERAL PUBLIC LICENSE

TERMS AND CONDITIONS FOR COPYING, DISTRIBUTION AND MODIFICATION

0. This License Agreement applies to any software library or other program which contains a notice placed by the copyright holder or other authorized party saying it may be distributed under the terms of this Lesser General Public License (also called "this License"). Each licensee is addressed as "you".

A "library" means a collection of software functions and/or data prepared so as to be conveniently linked with application programs (which use some of those functions and data) to form executables.

The "Library", below, refers to any such software library or work which has been distributed under these terms. A "work based on the Library" means either the Library or any derivative work under copyright law: that is to say, a work containing the Library or a portion of it, either verbatim or with modifications and/or translated straightforwardly into another language. (Hereinafter, translation is included without limitation in the term "modification".)

"Source code" for a work means the preferred form of the work for making modifications to it. For a library, complete source code means all the source code for all modules it contains, plus any associated interface definition files, plus the scripts used to control compilation and installation of the library.

Activities other than copying, distribution and modification are not covered by this License; they are outside its scope. The act of running a program using the Library is not restricted, and output from such a program is covered only if its contents constitute a work based on the Library (independent of the use of the Library in a tool for writing it). Whether that is true depends on what the Library does and what the program that uses the Library does.

1. You may copy and distribute verbatim copies of the Library's complete source code as you receive it, in any medium, provided that you conspicuously and appropriately publish on each copy an appropriate copyright notice and disclaimer of warranty; keep intact all the notices that refer to this License and to the absence of any warranty; and distribute a copy of this License along with the Library.

You may charge a fee for the physical act of transferring a copy, and you may at your option offer warranty protection in exchange for a fee.

2. You may modify your copy or copies of the Library or any portion of it, thus forming a work based on the Library, and copy and distribute such modifications or work under the terms of Section 1 above, provided that you also meet all of these conditions:

- a) The modified work must itself be a software library.
- b) You must cause the files modified to carry prominent notices stating that you changed the files and the date of any change.
- c) You must cause the whole of the work to be licensed at no charge to all third parties under the terms of this License.
- d) If a facility in the modified Library refers to a function or a table of data to be supplied by an application

program that uses the facility, other than as an argument passed when the facility is invoked, then you must make a good faith effort to ensure that, in the event an application does not supply such function or table, the facility still operates, and performs whatever part of its purpose remains meaningful.

(For example, a function in a library to compute square roots has a purpose that is entirely well-defined independent of the application. Therefore, Subsection 2d requires that any application-supplied function or table used by this function must be optional: if the application does not supply it, the square root function must still compute square roots.)

These requirements apply to the modified work as a whole. If identifiable sections of that work are not derived from the Library, and can be reasonably considered independent and separate works in themselves, then this License, and its terms, do not apply to those sections when you distribute them as separate works. But when you distribute the same sections as part of a whole which is a work based on the Library, the distribution of the whole must be on the terms of this License, whose permissions for other licensees extend to the entire whole, and thus to each and every part regardless of who wrote it.

Thus, it is not the intent of this section to claim rights or contest your rights to work written entirely by you; rather, the intent is to exercise the right to control the distribution of derivative or collective works based on the Library.

In addition, mere aggregation of another work not based on the Library with the Library (or with a work based on the Library) on a volume of a storage or distribution medium does not bring the other work under the scope of this License.

3. You may opt to apply the terms of the ordinary GNU General Public License instead of this License to a given copy of the Library. To do this, you must alter all the notices that refer to this License, so that they refer to the ordinary GNU General Public License, version 2, instead of to this License. (If a newer version than version 2 of the ordinary GNU General Public License has appeared, then you can specify that version instead if you wish.) Do not make any other change in these notices.

Once this change is made in a given copy, it is irreversible for that copy, so the ordinary GNU General Public License applies to all subsequent copies and derivative works made from that copy.

This option is useful when you wish to copy part of the code of the Library into a program that is not a library.

4. You may copy and distribute the Library (or a portion or derivative of it, under Section 2) in object code or executable form under the terms of Sections 1 and 2 above provided that you accompany it with the complete corresponding machine-readable source code, which must be distributed under the terms of Sections 1 and 2 above on a medium customarily used for software interchange.

If distribution of object code is made by offering access to work from a designated place, then offering equivalent access to copy the source code from the same place satisfies the requirement to distribute the source code, even though third parties are not compelled to copy the source along with the object code.

5. A program that contains no derivative of any portion of the Library, but is designed to work with the Library by being compiled or linked with it, is called a "work that uses the Library". Such a work, in isolation, is not a derivative work of the Library, and therefore falls outside the scope of this License.

However, linking a "work that uses the Library" with the Library creates an executable that is a derivative of the Library (because it contains portions of the Library), rather than a "work that uses the Library". The executable is therefore covered by this License. Section 6 states terms for distribution of such executables.

When a "work that uses the Library" uses material from a header file that is part of the Library, the object code for the work may be a derivative work of the Library even though the source code is not. Whether this is true is especially significant if the work can be linked without the Library, or if the work is itself a library. The threshold for this to be true is not precisely defined by law.

If such an object file uses only numerical parameters, data structure layouts and accessors, and small macros and small inline functions (ten lines or less in length), then the use of the object file is unrestricted, regardless of whether it is legally a derivative work. (Executables containing this object code plus portions of the Library will still fall under Section 6.)

Otherwise, if the work is a derivative of the Library, you may distribute the object code for the work under the terms of Section 6. Any executables containing that work also fall under Section 6, whether or not they are linked directly with the Library itself.

6. As an exception to the Sections above, you may also combine or link a "work that uses the Library" with the Library to produce a work containing portions of the Library, and distribute that work under terms of your choice, provided that the terms permit modification of the work for the customer's own use and reverse engineering for debugging such modifications.

You must give prominent notice with each copy of the work that the Library is used in it and that the Library and its use are covered by this License. You must supply a copy of this License. If the work during execution displays copyright notices, you must include the copyright notice for the Library among them, as well as a reference directing the user to the copy of this License. Also, you must do one of these things:

- a) Accompany the work with the complete corresponding machine-readable source code for the Library including whatever changes were used in the work (which must be distributed under Sections 1 and 2 above); and, if the work is an executable linked with the Library, with the complete machine-readable "work that uses the Library", as object code and/or source code, so that the user can modify the Library and then relink to produce a modified executable containing the modified Library. (It is understood that the user who changes the contents

- of definitions files in the Library will not necessarily be able to recompile the application to use the modified definitions.)
- b) Use a suitable shared library mechanism for linking with the Library. A suitable mechanism is one that (1) uses at run time a copy of the library already present on the user's computer system, rather than copying library functions into the executable, and (2) will operate properly with a modified version of the library, if the user installs one, as long as the modified version is interface-compatible with the version that the work was made with.
 - c) Accompany the work with a written offer, valid for at least three years, to give the same user the materials specified in Subsection 6a, above, for a charge no more than the cost of performing this distribution.
 - d) If distribution of the work is made by offering access to copy from a designated place, offer equivalent access to copy the above specified materials from the same place.
 - e) Verify that the user has already received a copy of these materials or that you have already sent this user a copy.

For an executable, the required form of the "work that uses the Library" must include any data and utility programs needed for reproducing the executable from it. However, as a special exception, the materials to be distributed need not include anything that is normally distributed (in either source or binary form) with the major components (compiler, kernel, and so on) of the operating system on which the executable runs, unless that component itself accompanies the executable.

It may happen that this requirement contradicts the license restrictions of other proprietary libraries that do not normally accompany the operating system. Such a contradiction means you cannot use both them and the Library together in an executable that you distribute.

7. You may place library facilities that are a work based on the Library side-by-side in a single library together with other library facilities not covered by this License, and distribute such a combined library, provided that the separate distribution of the work based on the Library and of the other library facilities is otherwise permitted, and provided that you do these two things:

- a) Accompany the combined library with a copy of the same work based on the Library, uncombined with any other library facilities. This must be distributed under the terms of the Sections above.
- b) Give prominent notice with the combined library of the fact that part of it is a work based on the Library, and explaining where to find the accompanying uncombined form of the same work.

8. You may not copy, modify, sublicense, link with, or distribute the Library except as expressly provided under this License. Any attempt otherwise to copy, modify, sublicense, link with, or distribute the Library is void, and will automatically terminate your rights under this License. However, parties who have received copies, or rights, from you under this license will not have their licenses terminated so long as such parties remain in full compliance.

9. You are not required to accept this License, since you have not signed it. However, nothing else grants you permission to modify or distribute the Library or its derivative works. These actions are prohibited by law if you do not accept this License. Therefore, by modifying or distributing the Library (or any work based on the Library), you indicate your acceptance of this License to do so, and all its terms and conditions for copying, distributing or modifying the Library or works based on it.

10. Each time you redistribute the Library (or any work based on the Library), the recipient automatically receives a license from the original licensor to copy, distribute, link with or modify the Library subject to these terms and conditions. You may not impose any further restrictions on the recipients' exercise of the rights granted herein. You are not responsible for enforcing compliance by third parties with this License.

11. If, as a consequence of a court judgment or allegation of patent infringement or for any other reason (not limited to patent issues), conditions are imposed on you (whether by court order, agreement or otherwise) that contradict the conditions of this License, they do not excuse you from the conditions of this License. If you cannot distribute so as to satisfy simultaneously your obligations under this License and any other pertinent obligations, then as a consequence you may not distribute the Library at all. For example, if a patent license would not permit royalty-free redistribution of the Library by all those who receive copies directly or indirectly through you, then the only way you could satisfy both it and this License would be to refrain entirely from distribution of the Library.

If any portion of this section is held invalid or unenforceable under any particular circumstance, the balance of the section is intended to apply, and the section as a whole is intended to apply in other circumstances.

It is not the purpose of this section to induce you to infringe any patents or other property right claims or to contest validity of any such claims; this section has the sole purpose of protecting the integrity of the free software distribution system which is implemented by public license practices. Many people have made generous contributions to the wide range of software distributed through that system in reliance on consistent application of that system; it is up to the author/donor to decide if he or she is willing to distribute software through any other system and a licensee cannot impose that choice.

This section is intended to make thoroughly clear what is believed to be a consequence of the rest of this License.

12. If the distribution and/or use of the Library is restricted in certain countries either by patents or by copyrighted interfaces, the original copyright holder who places the Library under this License may add an explicit geographical distribution limitation excluding those countries, so that distribution is permitted only in or among countries not thus

excluded. In such case, this License incorporates the limitation as if written in the body of this License.

13. The Free Software Foundation may publish revised and/or new versions of the Lesser General Public License from time to time. Such new versions will be similar in spirit to the present version, but may differ in detail to address new problems or concerns.

Each version is given a distinguishing version number. If the Library specifies a version number of this License which applies to it and "any later version", you have the option of following the terms and conditions either of that version or of any later version published by the Free Software Foundation. If the Library does not specify a license version number, you may choose any version ever published by the Free Software Foundation.

14. If you wish to incorporate parts of the Library into other free programs whose distribution conditions are incompatible with these, write to the author to ask for permission. For software which is copyrighted by the Free Software Foundation, write to the Free Software Foundation; we sometimes make exceptions for this. Our decision will be guided by the two goals of preserving the free status of all derivatives of our free software and of promoting the sharing and reuse of software generally.

NO WARRANTY

15. BECAUSE THE LIBRARY IS LICENSED FREE OF CHARGE, THERE IS NO WARRANTY FOR THE LIBRARY, TO THE EXTENT PERMITTED BY APPLICABLE LAW. EXCEPT WHEN OTHERWISE STATED IN WRITING THE COPYRIGHT HOLDERS AND/OR OTHER PARTIES PROVIDE THE LIBRARY "AS IS" WITHOUT WARRANTY OF ANY KIND, EITHER EXPRESSED OR IMPLIED, INCLUDING, BUT NOT LIMITED TO, THE IMPLIED WARRANTIES OF MERCHANTABILITY AND FITNESS FOR A PARTICULAR PURPOSE. THE ENTIRE RISK AS TO THE QUALITY AND PERFORMANCE OF THE LIBRARY IS WITH YOU. SHOULD THE LIBRARY PROVE DEFECTIVE, YOU ASSUME THE COST OF ALL NECESSARY SERVICING, REPAIR OR CORRECTION.

16. IN NO EVENT UNLESS REQUIRED BY APPLICABLE LAW OR AGREED TO IN WRITING WILL ANY COPYRIGHT HOLDER, OR ANY OTHER PARTY WHO MAY MODIFY AND/OR REDISTRIBUTE THE LIBRARY AS PERMITTED ABOVE, BE LIABLE TO YOU FOR DAMAGES, INCLUDING ANY GENERAL, SPECIAL, INCIDENTAL OR CONSEQUENTIAL DAMAGES ARISING OUT OF THE USE OR INABILITY TO USE THE LIBRARY (INCLUDING BUT NOT LIMITED TO LOSS OF DATA OR DATA BEING RENDERED INACCURATE OR LOSSES SUSTAINED BY YOU OR THIRD PARTIES OR A FAILURE OF THE LIBRARY TO OPERATE WITH ANY OTHER SOFTWARE), EVEN IF SUCH HOLDER OR OTHER PARTY HAS BEEN ADVISED OF THE POSSIBILITY OF SUCH DAMAGES.

END OF TERMS AND CONDITIONS

GNU LESSER GENERAL PUBLIC LICENSE, Version 3, 29 June 2007

Copyright (C) 2007 Free Software Foundation, Inc. <<http://fsf.org/>>

Everyone is permitted to copy and distribute verbatim copies of this license document, but changing it is not allowed.

This version of the GNU Lesser General Public License incorporates the terms and conditions of version 3 of the GNU General Public License, supplemented by the additional permissions listed below.

0. Additional Definitions.

As used herein, "this License" refers to version 3 of the GNU Lesser General Public License, and the "GNU GPL" refers to version 3 of the GNU General Public License.

"The Library" refers to a covered work governed by this License, other than an Application or a Combined Work as defined below.

An "Application" is any work that makes use of an interface provided by the Library, but which is not otherwise based on the Library. Defining a subclass of a class defined by the Library is deemed a mode of using an interface provided by the Library.

A "Combined Work" is a work produced by combining or linking an Application with the Library. The particular version of the Library with which the Combined Work was made is also called the "Linked Version".

The "Minimal Corresponding Source" for a Combined Work means the Corresponding Source for the Combined Work, excluding any source code for portions of the Combined Work that, considered in isolation, are based on the Application, and not on the Linked Version.

The "Corresponding Application Code" for a Combined Work means the object code and/or source code for the Application, including any data and utility programs needed for reproducing the Combined Work from the Application, but excluding the System Libraries of the Combined Work.

1. Exception to Section 3 of the GNU GPL.

You may convey a covered work under sections 3 and 4 of this License without being bound by section 3 of the GNU GPL.

2. Conveying Modified Versions.

If you modify a copy of the Library, and, in your modifications, a facility refers to a function or data to be supplied by an Application that uses the facility (other than as an argument passed when the facility is invoked), then you may convey a copy of the modified version:

- a) under this License, provided that you make a good faith effort to ensure that, in the event an Application does not supply the function or data, the facility still operates, and performs whatever part of its purpose remains meaningful, or

- b) under the GNU GPL, with none of the additional permissions of this License applicable to that copy.
- 3. Object Code Incorporating Material from Library Header Files.

The object code form of an Application may incorporate material from a header file that is part of the Library. You may convey such object code under terms of your choice, provided that, if the incorporated material is not limited to numerical parameters, data structure layouts and accessors, or small macros, inline functions and templates (ten or fewer lines in length), you do both of the following:

- a) Give prominent notice with each copy of the object code that the Library is used in it and that the Library and its use are covered by this License.
 - b) Accompany the object code with a copy of the GNU GPL and this license document.
4. Combined Works.

You may convey a Combined Work under terms of your choice that, taken together, effectively do not restrict modification of the portions of the Library contained in the Combined Work and reverse engineering for debugging such modifications, if you also do each of the following:

- a) Give prominent notice with each copy of the Combined Work that the Library is used in it and that the Library and its use are covered by this License.
 - b) Accompany the Combined Work with a copy of the GNU GPL and this license document.
 - c) For a Combined Work that displays copyright notices during execution, include the copyright notice for the Library among these notices, as well as a reference directing the user to the copies of the GNU GPL and this license document.
 - d) Do one of the following:
 - 0) Convey the Minimal Corresponding Source under the terms of this License, and the Corresponding Application Code in a form suitable for, and under terms that permit, the user to recombine or relink the Application with a modified version of the Linked Version to produce a modified Combined Work, in the manner specified by section 6 of the GNU GPL for conveying Corresponding Source.
 - 1) Use a suitable shared library mechanism for linking with the Library. A suitable mechanism is one that (a) uses at run time a copy of the Library already present on the user's computer system, and (b) will operate properly with a modified version of the Library that is interface-compatible with the Linked Version.
 - e) Provide Installation Information, but only if you would otherwise be required to provide such information under section 6 of the GNU GPL, and only to the extent that such information is necessary to install and execute a modified version of the Combined Work produced by recombining or relinking the Application with a modified version of the Linked Version. (If you use option 4d0, the Installation Information must accompany the Minimal Corresponding Source and Corresponding Application Code. If you use option 4d1, you must provide the Installation Information in the manner specified by section 6 of the GNU GPL for conveying Corresponding Source.)
5. Combined Libraries.

You may place library facilities that are a work based on the Library side by side in a single library together with other library facilities that are not Applications and are not covered by this License, and convey such a combined library under terms of your choice, if you do both of the following:

- a) Accompany the combined library with a copy of the same work based on the Library, uncombined with any other library facilities, conveyed under the terms of this License.
 - b) Give prominent notice with the combined library that part of it is a work based on the Library, and explaining where to find the accompanying uncombined form of the same work.
6. Revised Versions of the GNU Lesser General Public License.

The Free Software Foundation may publish revised and/or new versions of the GNU Lesser General Public License from time to time. Such new versions will be similar in spirit to the present version, but may differ in detail to address new problems or concerns.

Each version is given a distinguishing version number. If the Library as you received it specifies that a certain numbered version of the GNU Lesser General Public License "or any later version" applies to it, you have the option of following the terms and conditions either of that published version or of any later version published by the Free Software Foundation. If the Library as you received it does not specify a version number of the GNU Lesser General Public License, you may choose any version of the GNU Lesser General Public License ever published by the Free Software Foundation.

If the Library as you received it specifies that a proxy can decide whether future versions of the GNU Lesser General Public License shall apply, that proxy's public statement of acceptance of any version is permanent authorization for you to choose that version for the Library.

(This page intentionally left blank.)

(This page intentionally left blank.)

(This page intentionally left blank.)

K5902031-01
October 2011

CE
0120

Barco n.v.
President Kennedypark 35
8500 Kortrijk
Belgium
www.barco.com