

Quick Reference

Copy

Making copies

- 1 Load an original document into the ADF tray or on the scanner glass.

Note: To avoid a cropped image, make sure that the original document and output have the same paper size.

- 2 From the home screen, touch **Copy**, and then specify the number of copies.

If necessary, adjust the copy settings.

- 3 Copy the document.

Note: To make a quick copy, from the home screen, touch .

Copying on both sides of the paper

- 1 Load an original document into the ADF tray or on the scanner glass.

- 2 From the home screen, touch **Copy > Sides**.

- 3 Touch **1 sided to 2 sided** or **2 sided to 2 sided**.

- 4 Copy the document.

Copying multiple pages onto a single sheet

- 1 Load an original document into the ADF tray or on the scanner glass.

- 2 From the home screen, touch **Copy > Pages per Side**.

- 3 Adjust the settings.

- 4 Copy the document.

E-mail

Configuring the e-mail SMTP settings

Configure the Simple Mail Transfer Protocol (SMTP) settings to send a scanned document through e-mail. The settings vary with each e-mail service provider.

Before you begin, make sure that the printer is connected to a network and that the network is connected to the Internet.

Using the Embedded Web Server

- 1 Open a web browser, and then type the printer IP address in the address field.

Notes:

- View the printer IP address on the printer home screen. The IP address appears as four sets of numbers separated by periods, such as 123.123.123.123.
- If you are using a proxy server, then temporarily disable it to load the web page correctly.

- 2 Click **Settings > E-mail**.

- 3 From the E-mail Setup section, configure the settings.

Notes:

- For more information on the password, see the list of [e-mail service providers](#).
- For e-mail service providers that are not on the list, contact your provider and ask for the settings.

- 4 Click **Save**.

Using the Settings menu in the printer

- 1 From the home screen, touch **Settings > E-mail > E-mail Setup**.

- 2 Configure the settings.

Notes:

- For more information on the password, see the list of [e-mail service providers](#).
- For e-mail service providers that are not on the list, contact your provider and ask for the settings.

E-mail service providers

- [AOL Mail](#)
- [Comcast Mail](#)

- [Gmail](#)
- [iCloud Mail](#)
- [Mail.com](#)
- [NetEase Mail \(mail.126.com\)](#)
- [NetEase Mail \(mail.163.com\)](#)
- [NetEase Mail \(mail.yeah.net\)](#)
- [Outlook Live or Microsoft 365](#)
- [QQ Mail](#)
- [Sina Mail](#)
- [Sohu Mail](#)
- [Yahoo! Mail](#)
- [Zoho Mail](#)

Notes:

- If you encounter errors using the settings provided, then contact your e-mail service provider.
- For e-mail service providers that are not on the list, contact your provider.

AOL Mail

Setting	Value
Primary SMTP Gateway	smtp.aol.com
Primary SMTP Gateway Port	587
Use SSL/TLS	Required
Require Trusted Certificate	Disabled
Reply Address	Your e-mail address
SMTP Server Authentication	Login / Plain
Device-Initiated E-mail	Use Device SMTP Credentials
Device UserID	Your e-mail address
Device Password	App password Note: To create an app password, go to the AOL Account Security page, log in to your account, and then click Generate app password .

Comcast Mail

Setting	Value
Primary SMTP Gateway	smtp.comcast.net
Primary SMTP Gateway Port	587
Use SSL/TLS	Required
Require Trusted Certificate	Disabled
Reply Address	Your e-mail address
SMTP Server Authentication	Login / Plain
Device-Initiated E-mail	Use Device SMTP Credentials
Device UserID	Your e-mail address
Device Password	Account password

Note: Make sure that the Third Party Access Security setting is enabled on your account. For more information, go to the [Comcast Xfinity Connect help page](#).

Gmail™

Note: Make sure that two-step verification is enabled on your Google account. To enable two-step verification, go to the [Google Account Security](#) page, log in to your account, and then from the “Signing in to Google” section, click **2-Step Verification**.

Setting	Value
Primary SMTP Gateway	smtp.gmail.com
Primary SMTP Gateway Port	587
Use SSL/TLS	Required
Require Trusted Certificate	Disabled
Reply Address	Your e-mail address
SMTP Server Authentication	Login / Plain
Device-Initiated E-mail	Use Device SMTP Credentials
Device UserID	Your e-mail address

Setting	Value
Device Password	App password Notes: <ul style="list-style-type: none"> To create an app password, go to the Google Account Security page, log in to your account, and then from the “Signing in to Google” section, click App passwords. “App passwords” shows only if two-step verification is enabled.

iCloud Mail

Note: Make sure that two-step verification is enabled on your account.

Setting	Value
Primary SMTP Gateway	smtp.mail.me.com
Primary SMTP Gateway Port	587
Use SSL/TLS	Required
Require Trusted Certificate	Disabled
Reply Address	Your e-mail address
SMTP Server Authentication	Login / Plain
Device-Initiated E-mail	Use Device SMTP Credentials
Device UserID	Your e-mail address
Device Password	App password Note: To create an app password, go to the iCloud Account Management page, log in to your account, and then from the Security section, click Generate Password .

Mail.com

Setting	Value
Primary SMTP Gateway	smtp.mail.com
Primary SMTP Gateway Port	587

Setting	Value
Use SSL/TLS	Required
Require Trusted Certificate	Disabled
Reply Address	Your e-mail address
SMTP Server Authentication	Login / Plain
Device-Initiated E-mail	Use Device SMTP Credentials
Device UserID	Your e-mail address
Device Password	Account password

NetEase Mail (mail.126.com)

Note: Make sure that the SMTP service is enabled on your account. To enable the service, from the NetEase Mail home page, click **Settings > POP3/SMTP/IMAP**, and then enable either **IMAP/SMTP service** or **POP3/SMTP service**.

Setting	Value
Primary SMTP Gateway	smtp.126.com
Primary SMTP Gateway Port	465
Use SSL/TLS	Required
Require Trusted Certificate	Disabled
Reply Address	Your e-mail address
SMTP Server Authentication	Login / Plain
Device-Initiated E-mail	Use Device SMTP Credentials
Device UserID	Your e-mail address
Device Password	Authorization password Note: The authorization password is provided when IMAP/SMTP service or POP3/SMTP service is enabled.

NetEase Mail (mail.163.com)

Note: Make sure that the SMTP service is enabled on your account. To enable the service, from the NetEase Mail home page, click **Settings > POP3/SMTP/IMAP**, and then enable either **IMAP/SMTP service** or **POP3/SMTP service**.

Setting	Value
Primary SMTP Gateway	smtp.163.com
Primary SMTP Gateway Port	465
Use SSL/TLS	Required
Require Trusted Certificate	Disabled
Reply Address	Your e-mail address
SMTP Server Authentication	Login / Plain
Device-Initiated E-mail	Use Device SMTP Credentials
Device UserID	Your e-mail address
Device Password	Authorization password Note: The authorization password is provided when IMAP/SMTP service or POP3/SMTP service is enabled.

NetEase Mail (mail.yeah.net)

Note: Make sure that the SMTP service is enabled on your account. To enable the service, from the NetEase Mail home page, click **Settings > POP3/SMTP/IMAP**, and then enable either **IMAP/SMTP service** or **POP3/SMTP service**.

Setting	Value
Primary SMTP Gateway	smtp.yeah.net
Primary SMTP Gateway Port	465
Use SSL/TLS	Required
Require Trusted Certificate	Disabled
Reply Address	Your e-mail address
SMTP Server Authentication	Login / Plain
Device-Initiated E-mail	Use Device SMTP Credentials
Device UserID	Your e-mail address

Setting	Value
Device Password	Authorization password Note: The authorization password is provided when IMAP/SMTP service or POP3/SMTP service is enabled.

Outlook Live or Microsoft 365

These settings apply to outlook.com and hotmail.com e-mail domains, and Microsoft 365 accounts.

Setting	Value
Primary SMTP Gateway	smtp.office365.com
Primary SMTP Gateway Port	587
Use SSL/TLS	Required
Require Trusted Certificate	Disabled
Reply Address	Your e-mail address
SMTP Server Authentication	Login / Plain
Device-Initiated E-mail	Use Device SMTP Credentials
Device UserID	Your e-mail address
Device Password	Account password or app password Notes: <ul style="list-style-type: none"> For accounts with two-step verification disabled, use your account password. For outlook.com or hotmail.com accounts with two-step verification enabled, use an app password. To create an app password, go to the Outlook Live Account Management page, and then log in to your account.

Note: For additional setup options for business using Microsoft 365, go to the [Microsoft 365 help page](#).

QQ Mail

Note: Make sure that the SMTP service is enabled on your account. To enable the service, from the QQ Mail home page, click **Settings > Account**. From the POP3/IMAP/SMTP/Exchange/CardDAV/CalDAV Service section, enable either **POP3/SMTP service** or **IMAP/SMTP service**.

Setting	Value
Primary SMTP Gateway	smtp.qq.com
Primary SMTP Gateway Port	587
Use SSL/TLS	Required
Require Trusted Certificate	Disabled
Reply Address	Your e-mail address
SMTP Server Authentication	Login / Plain
Device-Initiated E-mail	Use Device SMTP Credentials
Device UserID	Your e-mail address
Device Password	Authorization code Note: To generate an authorization code, from the QQ Mail home page, click Settings > Account , and then from the POP3/IMAP/SMTP/Exchange/CardDAV/CalDAV Service section, click Generate authorization code .

Sina Mail

Note: Make sure that the POP3/SMTP service is enabled on your account. To enable the service, from the Sina Mail home page, click **Settings > More settings > User-end POP/IMAP/SMTP**, and then enable **POP3/SMTP service**.

Setting	Value
Primary SMTP Gateway	smtp.sina.com
Primary SMTP Gateway Port	587
Use SSL/TLS	Required

Setting	Value
Require Trusted Certificate	Disabled
Reply Address	Your e-mail address
SMTP Server Authentication	Login / Plain
Device-Initiated E-mail	Use Device SMTP Credentials
Device UserID	Your e-mail address
Device Password	Authorization code Note: To create an authorization code, from the e-mail home page, click Settings > More settings > User-end POP/IMAP/SMTP , and then enable Authorization code status .

Sohu Mail

Note: Make sure that the SMTP service is enabled on your account. To enable the service, from the Sohu Mail home page, click **Options > Settings > POP3/SMTP/IMAP**, and then enable either **IMAP/SMTP service** or **POP3/SMTP service**.

Setting	Value
Primary SMTP Gateway	smtp.sohu.com
Primary SMTP Gateway Port	465
Use SSL/TLS	Required
Require Trusted Certificate	Disabled
Reply Address	Your e-mail address
SMTP Server Authentication	Login / Plain
Device-Initiated E-mail	Use Device SMTP Credentials
Device UserID	Your e-mail address
Device Password	Independent password Note: The independent password is provided when IMAP/SMTP service or POP3/SMTP service is enabled.

Yahoo! Mail

Setting	Value
Primary SMTP Gateway	smtp.mail.yahoo.com
Primary SMTP Gateway Port	587
Use SSL/TLS	Required
Require Trusted Certificate	Disabled
Reply Address	Your e-mail address
SMTP Server Authentication	Login / Plain
Device-Initiated E-mail	Use Device SMTP Credentials
Device UserID	Your e-mail address
Device Password	App password Note: To create an app password, go to the Yahoo Account Security page, log in to your account, and then click Generate app password .

Zoho Mail

Setting	Value
Primary SMTP Gateway	smtp.zoho.com
Primary SMTP Gateway Port	587
Use SSL/TLS	Required
Require Trusted Certificate	Disabled
Reply Address	Your e-mail address
SMTP Server Authentication	Login / Plain
Device-Initiated E-mail	Use Device SMTP Credentials
Device UserID	Your e-mail address

Setting	Value
Device Password	Account password or app password Notes: <ul style="list-style-type: none"> For accounts with two-step verification disabled, use your account password. For accounts with two-step verification enabled, use an app password. To create an app password, go to the Zoho Mail Account Security page, log in to your account, and then from the Application-Specific Passwords section, click Generate New Password.

Sending an e-mail

Before you begin, make sure that the SMTP settings are configured. For more information, see "[Configuring the e-mail SMTP settings](#)" on page 1.

- 1 Load an original document into the ADF tray or on the scanner glass.
- 2 From the home screen, touch **E-mail**, and then enter the needed information.
- 3 If necessary, configure the scan settings.
- 4 Send the e-mail.

Scan

Scanning to a computer

Before you begin, make sure that the computer and the printer are connected to the same network.

For Windows users

Note: Make sure that the printer is added to the computer. For more information, see "[Adding printers to a computer](#)" on page 11.

- 1 Load an original document into the automatic document feeder or on the scanner glass.

- 2 From the computer, open **Windows Fax and Scan**.
- 3 From the Source menu, select a scanner source.
- 4 If necessary, change the scan settings.
- 5 Scan the document.

For Macintosh users

Note: Make sure that the printer is added to the computer. For more information, see [“Adding printers to a computer” on page 11](#).

- 1 Load an original document into the automatic document feeder or on the scanner glass.
- 2 From the computer, do either of the following:
 - Open **Image Capture**.
 - Open **Printers & Scanners**, and then select a printer. Click **Scan > Open Scanner**.
- 3 From the Scanner window, do one or more of the following:
 - Select where you want to save the scanned document.
 - Select the size of the original document.
 - To scan from the ADF, select **Document Feeder** from the Scan Menu or enable **Use Document Feeder**.
 - If necessary, configure the scan settings.
- 4 Click **Scan**.

Fax

Setting up the printer to fax

Setting up the fax function using analog fax

Notes:

- For some printer models, a fax card must be installed for the printer to use analog fax.
- Some connection methods are applicable only in some countries or regions.
- If the fax function is enabled and not fully set up, then the indicator light may blink red.
- If you do not have a TCP/IP environment, then use the control panel to set up fax.

Warning—Potential Damage: To avoid loss of data or printer malfunction, do not touch cables or the printer in the area shown while actively sending or receiving a fax.



Using the Settings menu in the printer

- 1 From the home screen, touch **Settings > Fax > Fax Setup > General Fax Settings**.
- 2 Configure the settings.

Using the Embedded Web Server

- 1 Open a web browser, and then type the printer IP address in the address field.

Notes:

- View the printer IP address on the home screen. The IP address appears as four sets of numbers separated by periods, such as 123.123.123.123.
- If you are using a proxy server, then temporarily disable it to load the web page correctly.

- 2 Click **Settings > Fax > Fax Setup > General Fax Settings**.
- 3 Configure the settings.
- 4 Apply the changes.

Setting up the fax function using fax server

Notes:

- This feature lets you send fax messages to a fax service provider that supports e-mail receiving.
- This feature supports outgoing fax messages only. To support fax receive, make sure that you have a device-based fax, such as analog fax, etherFAX, or Fax over IP (FoIP), configured in your printer.

- 1 Open a web browser, and then type the printer IP address in the address field.

Notes:

- View the printer IP address on the home screen. The IP address appears as four sets of numbers separated by periods, such as 123.123.123.123.
- If you are using a proxy server, then temporarily disable it to load the web page correctly.

- 2 Click **Settings > Fax**.

- 3 From the Fax Mode menu, select **Fax Server**, and then click **Save**.

- 4 Click **Fax Server Setup**.

- 5 In the To Format field, type **[#]@myfax.com**, where **[#]** is the fax number and **myfax.com** is the fax provider domain.

Notes:

- If necessary, configure the Reply Address, Subject, or Message fields.
- To let the printer receive fax messages, enable the device-based fax receive setting. Make sure that you have a device-based fax configured.

- 6 Click **Save**.

- 7 Click **Fax Server E-mail Settings**, and then do either of the following:

- Enable **Use E-mail SMTP Server**.

Note: If the E-mail SMTP settings are not configured, then see [“Configuring the e-mail SMTP settings” on page 1](#).

- Configure the SMTP settings. For more information, contact your e-mail service provider.

- 8 Apply the changes.

Sending a fax

Note: Make sure that fax is configured. For more information, see the [Setting up the printer to fax](#) section.

Using the control panel

- 1 Load an original document into the ADF tray or on the scanner glass.
- 2 From the home screen, touch **Fax**, and then enter the needed information.
If necessary, adjust the settings.
- 3 Send the fax.

Using the computer

Before you begin, make sure that the fax driver is installed. For more information, see ["Installing the fax driver" on page 11](#).

For Windows users

- 1 From the document that you are trying to fax, open the Print dialog.
- 2 Select the printer, and then click **Properties, Preferences, Options, or Setup**.
- 3 Click **Fax > Enable fax > Always display settings prior to faxing**, and then enter the recipient number.
If necessary, configure other fax settings.
- 4 Send the fax.

For Macintosh users

- 1 With a document open, choose **File > Print**.
- 2 Select the printer that has - **Fax** added after its name.
- 3 In the To field, enter the recipient number.
If necessary, configure other fax settings.
- 4 Send the fax.

Print

Printing from a computer

Note: For labels, card stock, and envelopes, set the paper size and type in the printer before printing the document.



- 1 From the document that you are trying to print, open the Print dialog.
- 2 If necessary, adjust the settings.
- 3 Print the document.

Printing from a mobile device

Printing from a mobile device using Mopria Print Service

Mopria® Print Service is a mobile printing solution for mobile devices running on Android™ version 5.0 or later. It allows you to print directly to any Mopria-certified printer.

Note: Make sure that you download the Mopria Print Service application from the Google Play™ store and enable it in the mobile device.

- 1 From your Android mobile device, launch a compatible application or select a document from your file manager.
- 2 Tap  > **Print**.
- 3 Select a printer, and then adjust the settings, if necessary.
- 4 Tap .

Printing from a mobile device using AirPrint

The AirPrint software feature is a mobile printing solution that allows you to print directly from Apple devices to an AirPrint-certified printer.

Notes:

- Make sure that the Apple device and the printer are connected to the same network. If the network has multiple wireless hubs, then make sure that both devices are connected to the same subnet.



- This application is supported only in some Apple devices.

- 1 From your mobile device, select a document from your file manager or launch a compatible application.
- 2 Tap  > **Print**.
- 3 Select a printer, and then adjust the settings, if necessary.
- 4 Print the document.

Printing from a mobile device using Wi-Fi Direct®

Wi-Fi Direct® is a printing service that lets you print to any Wi-Fi Direct-ready printer.

Note: Make sure that the mobile device is connected to the printer wireless network. For more information, see ["Connecting a mobile device to the printer" on page 12](#).

- 1 From your mobile device, launch a compatible application or select a document from your file manager.
- 2 Depending on your mobile device, do one of the following:
 - Tap  > **Print**.
 - Tap  > **Print**.
 - Tap  > **Print**.
- 3 Select a printer, and then adjust the settings, if necessary.
- 4 Print the document.

Printing confidential and other held jobs

For Windows users

- 1 With a document open, click **File > Print**.
- 2 Select a printer, and then click **Properties, Preferences, Options, or Setup**.
- 3 Click **Print and Hold**.
- 4 Select **Use Print and Hold**, and then assign a user name.
- 5 Select the print job type (Confidential, Repeat, Reserve, or Verify).
If you select **Confidential**, then secure the print job with a personal identification number (PIN).
- 6 Click **OK** or **Print**.

- 7 From the printer home screen, release the print job.
 - For confidential print jobs, touch **Held jobs** > select your user name > **Confidential** > enter the PIN > select the print job > configure the settings > **Print**.
 - For other print jobs, touch **Held jobs** > select your user name > select the print job > configure the settings > **Print**.

For Macintosh users

Using AirPrint

- 1 With a document open, choose **File > Print**.
- 2 Select a printer, and then from the drop-down menu following the Orientation menu, choose **PIN Printing**.
- 3 Enable **Print with PIN**, and then enter a four-digit PIN.
- 4 Click **Print**.
- 5 From the printer home screen, release the print job. Touch **Held jobs** > select your computer name > **Confidential** > enter the PIN > select the print job > **Print**.

Using the print driver

- 1 With a document open, choose **File > Print**.
- 2 Select a printer, and then from the drop-down menu following the Orientation menu, choose **Print and Hold**.
- 3 Choose **Confidential Print**, and then enter a four-digit PIN.
- 4 Click **Print**.
- 5 From the printer home screen, release the print job. Touch **Held jobs** > select your computer name > **Confidential** > select the print job > enter the PIN > **Print**.

Maintain the printer

Attaching cables

CAUTION—SHOCK HAZARD: To avoid the risk of electrical shock, do not set up this product or make any electrical or cabling connections, such as the power cord, fax feature, or telephone, during a lightning storm.

CAUTION—POTENTIAL INJURY: To avoid the risk of fire or electrical shock, connect the power cord to an appropriately rated and properly grounded electrical outlet that is near the product and easily accessible.

CAUTION—POTENTIAL INJURY: To avoid the risk of fire or electrical shock, use only the power cord provided with this product or the manufacturer's authorized replacement.

CAUTION—POTENTIAL INJURY: To reduce the risk of fire, use only a 26 AWG or larger telecommunications (RJ-11) cord when connecting this product to the public switched telephone network. For users in Australia, the cord must be approved by the Australian Communications and Media Authority.

Warning—Potential Damage: To avoid loss of data or printer malfunction, do not touch the USB cable, any wireless network adapter, or the printer in the areas shown while actively printing.

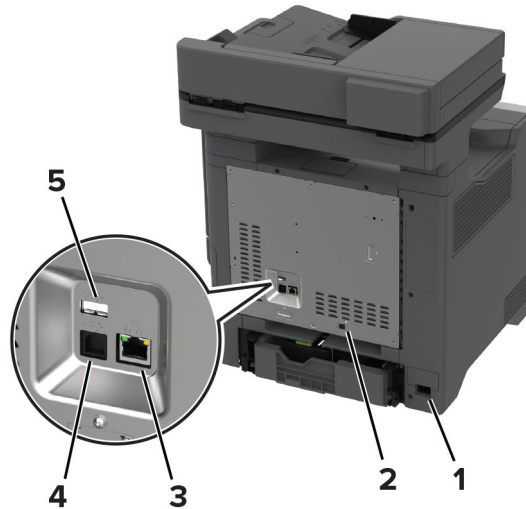

	Printer port	Function
5	USB port	Attach a keyboard or any compatible option.

	Printer port	Function
1	Power cord socket	Connect the printer to a properly grounded electrical outlet.
2	LINE port Note: Available only in some printer models.	Connect the printer to an active telephone line through a standard wall jack (RJ-11), DSL filter, or VoIP adapter, or any other adapter that allows you to access the telephone line to send and receive faxes.
3	Ethernet port	Connect the printer to a network.
4	USB printer port	Connect the printer to a computer.

Replacing a toner cartridge

1 Open door B.

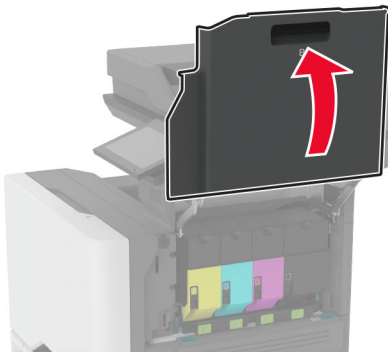
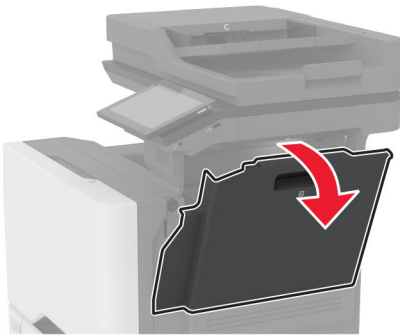
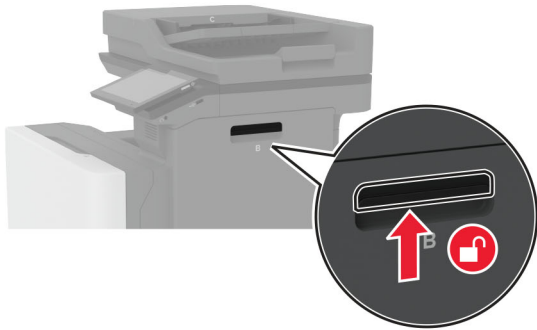

2 Remove the used toner cartridge.

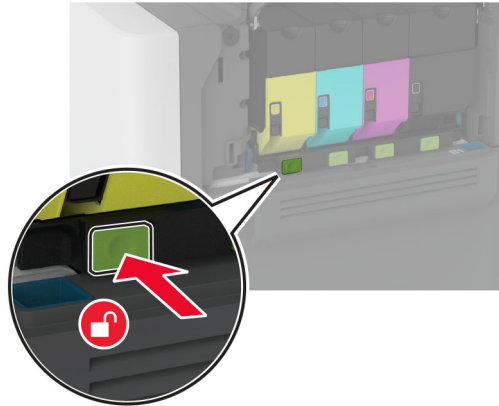

3 Unpack the new toner cartridge.

4 Insert the new toner cartridge.

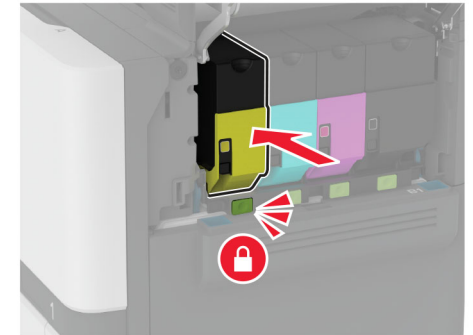

5 Close door B.

Loading trays

 **CAUTION—TIPPING HAZARD:** To reduce the risk of equipment instability, load each tray separately. Keep all other trays closed until needed.

1 Remove the tray.

Note: To avoid jams, do not remove trays while the printer is busy.

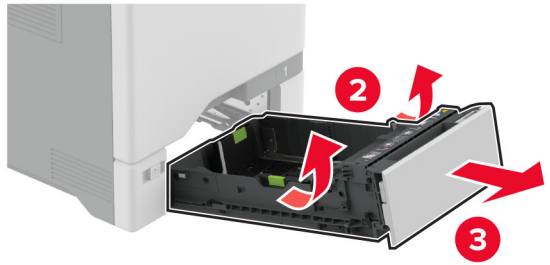
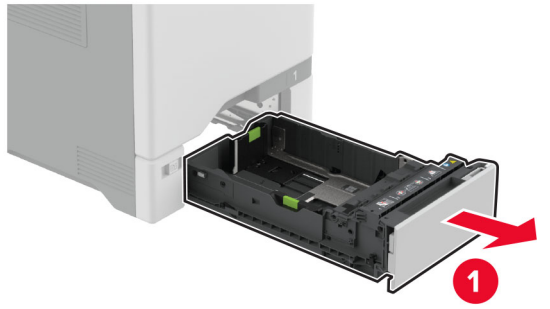

2 Adjust the guides to match the size of the paper that you are loading.

Note: Use the indicators on the bottom of the tray to position the guides.

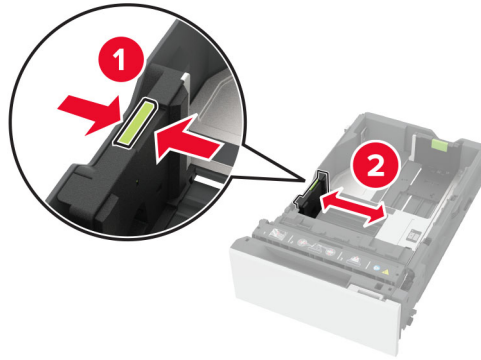

3 Flex, fan, and align the paper edges before loading.

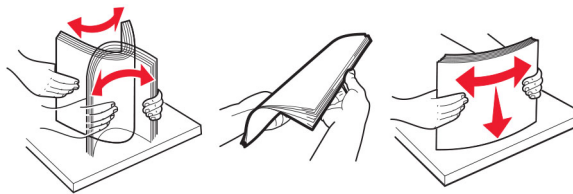

4 Load the paper stack with the printable side faceup.

- For one-sided printing, load letterhead faceup with the header toward the front of the tray.
- For two-sided printing, load letterhead facedown with the header toward the back of the tray.
- Do not slide paper into the tray.

- For plain paper, make sure that the stack height is below the maximum paper fill indicator. Overfilling may cause paper jams.

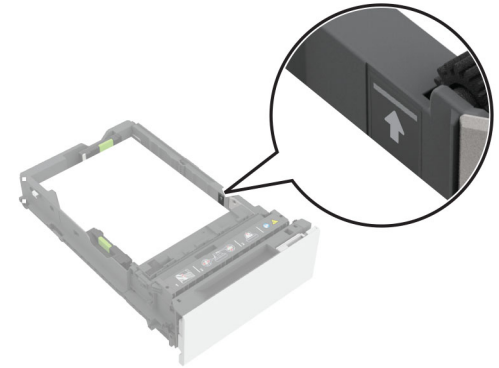

- For envelopes and other specialty media, make sure that the stack height is below the dashed line. Overfilling may cause paper jams.

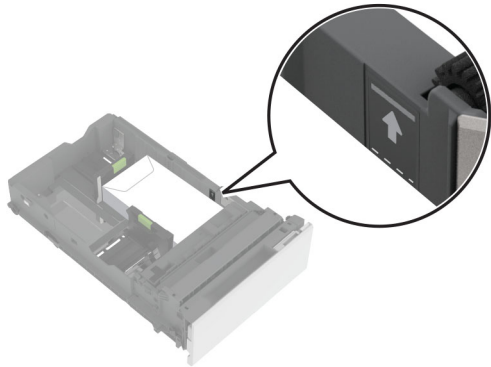
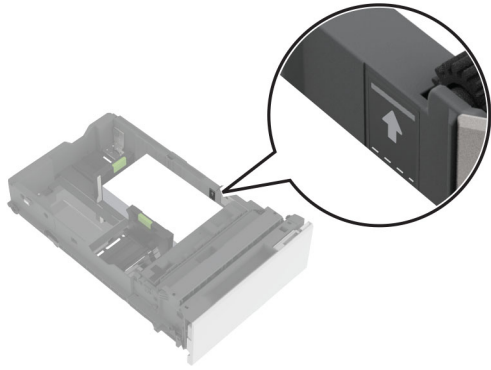

- 5** Insert the tray.
If necessary, set the paper size and type to match the paper loaded in the tray.

Loading the multipurpose feeder

- 1** Open the multipurpose feeder.

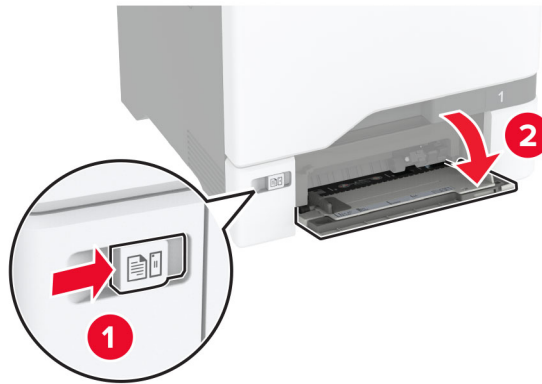

- 2** Adjust the guide to match the size of the paper that you are loading.



- 3** Flex, fan, and align the paper edges before loading.

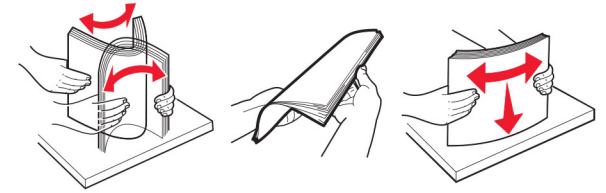

- 4** Load the paper.

- Load paper and card stock with the printable side facedown and the top edge entering the printer first.



- Load envelope with the flap side up and against the right side of the paper guide. Load European envelopes with the flap entering the printer first.



Warning—Potential Damage: Do not use envelopes with stamps, clasps, snaps, windows, coated linings, or self-stick adhesives.

Note: To avoid paper pick problems, make sure that the leading edge of the paper or specialty media is properly aligned with the separator dam.

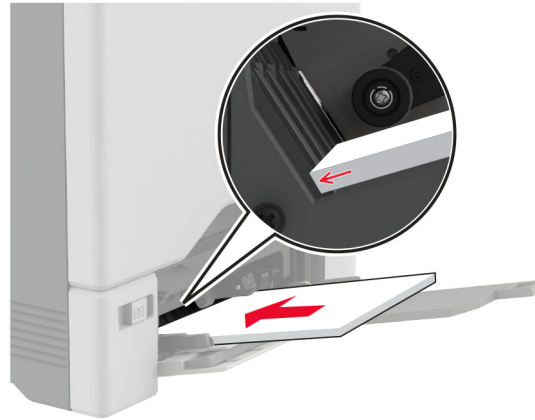

- 5 From the Paper menu in the control panel, set the paper size and type to match the paper loaded in the multipurpose feeder.

Setting the size and type of the specialty media

The trays automatically detect the size of plain paper. For specialty media like labels, card stock, or envelopes, do the following:

- 1 From the home screen, touch **Settings > Paper > Tray Configuration > Paper Size/Type** > select a paper source.
- 2 Set the size and type of the specialty media.

Installing the printer software

Notes:

- The print driver is included in the software installer package.
 - For Macintosh computers with macOS version 10.7 or later, you do not need to install the driver to print on an AirPrint-certified printer. If you want custom printing features, then download the print driver.
- 1 Obtain a copy of the software installer package.
 - From the software CD that came with your printer.
 - From our website or the place where you purchased the printer.
 - 2 Run the installer, and then follow the instructions on the computer screen.

Installing the fax driver

- 1 Go to our website or the place where you purchased the printer, and then obtain the installer package.
- 2 Run the installer, and then follow the instructions on the computer screen.

Updating firmware

To enhance printer performance and fix issues, update the printer firmware regularly.

For more information on updating the firmware, contact your sales representative.

- 1 Open a web browser, and then type the printer IP address in the address field.

Notes:

- View the printer IP address on the printer home screen. The IP address appears as four sets of numbers separated by periods, such as 123.123.123.123.
- If you are using a proxy server, then temporarily disable it to load the web page correctly.

- 2 Click **Settings > Device > Update Firmware**.

- 3 Do either of the following:

- Click **Check for updates > I agree, start update**.
- Upload the flash file.
 - a Browse to the flash file.
 - b Click **Upload > Start**.

Adding printers to a computer

Before you begin, do one of the following:

- Connect the printer and the computer to the same network. For more information on connecting the printer to a network, see [“Connecting the printer to a Wi-Fi network” on page 12](#).
- Connect the computer to the printer. For more information, see [“Connecting a computer to the printer” on page 12](#).
- Connect the printer to the computer using a USB cable. For more information, see [“Attaching cables” on page 7](#).

Note: The USB cable is sold separately.

For Windows users

- 1 From a computer, install the print driver.

Note: For more information, see [“Installing the printer software” on page 11.](#)

- 2 Open **Printers & scanners**, and then click **Add a printer or scanner**.
 - 3 Depending on your printer connection, do one of the following:
 - Select a printer from the list, and then click **Add device**.
 - Click **Show Wi-Fi Direct printers**, select a printer, and then click **Add device**.
 - Click **The printer that I want isn't listed**, and then from the Add Printer window, do the following:
 - a Select **Add a printer using a TCP/IP address or hostname**, and then click **Next**.
 - b In the “Hostname or IP address” field, type the printer IP address, and then click **Next**.
- Notes:**
- View the printer IP address on the printer home screen. The IP address appears as four sets of numbers separated by periods, such as 123.123.123.123.
 - If you are using a proxy server, then temporarily disable it to load the web page correctly.
- c Select a print driver, and then click **Next**.
 - d Select **Use the print driver that is currently installed (recommended)**, and then click **Next**.
 - e Type a printer name, and then click **Next**.
 - f Select a printer sharing option, and then click **Next**.
 - g Click **Finish**.

For Macintosh users

- 1 From a computer, open **Printers & Scanners**.
- 2 Click **+**, and then select a printer.
- 3 From the Use menu, select a print driver.

Notes:

- To use the Macintosh print driver, select either **AirPrint** or **Secure AirPrint**.
 - If you want custom printing features, then select the manufacturer print driver. To install the driver, see [“Installing the printer software” on page 11.](#)
- 4 Add the printer.

Connecting the printer to a Wi-Fi network

Before you begin, make sure that:

- A wireless module is installed in your printer.
- Active Adapter is set to Auto. From the home screen, touch **Settings > Network/Ports > Network Overview > Active Adapter**.

- 1 From the home screen, touch **Settings > Network/Ports > Wireless > Setup On Printer Panel > Choose Network**.
- 2 Select a Wi-Fi network, and then type the network password.

Note: For printers that are Wi-Fi-network-ready, a prompt to set up the Wi-Fi network appears during initial setup.

Configuring Wi-Fi Direct

Wi-Fi Direct® allows wireless devices to connect directly to a Wi-Fi Direct-enabled printer without using an access point (wireless router).

Before you begin, make sure that:

- A wireless module is installed on your printer.
- Active Adapter is set to Auto. From the home screen, touch **Settings > Network/Ports > Network Overview > Active Adapter**.

- 1 From the home screen, touch **Settings > Network/Ports > Wi-Fi Direct**.
- 2 Configure the settings.

- **Enable Wi-Fi Direct**—Enables the printer to broadcast its own Wi-Fi Direct network.
- **Wi-Fi Direct Name**—Assigns a name for the Wi-Fi Direct network.
- **Wi-Fi Direct Password**—Assigns the password for negotiating the wireless security when using the peer-to-peer connection.
- **Show Password on Setup Page**—Shows the password on the Network Setup Page.
- **Auto-Accept Push Button Requests**—Lets the printer accept connection requests automatically.

Note: Accepting push-button requests automatically is not secured.

Notes:

- By default, the Wi-Fi Direct network password is not visible on the printer display. To show the password, enable the

password peek icon. From the home screen, touch **Settings > Security > Miscellaneous > Enable Password/PIN Reveal**.

- You can see the password of the Wi-Fi Direct network without showing it on the printer display. From the home screen, touch **Settings > Reports > Network > Network Setup Page**.

Connecting a computer to the printer

Before connecting your computer, make sure that Wi-Fi Direct has been configured. For more information, see [“Configuring Wi-Fi Direct” on page 12.](#)

For Windows users

- 1 Open **Printers & scanners**, and then click **Add a printer or scanner**.
- 2 Click **Show Wi-Fi Direct printers**, and then select the printer Wi-Fi Direct name.
- 3 From the printer display, take note of the eight-digit PIN of the printer.
- 4 Enter the PIN on the computer.

Note: If the print driver is not already installed, then Windows downloads the appropriate driver.

For Macintosh users

- 1 Click the wireless icon, and then select the printer Wi-Fi Direct name.
- Note:** The string DIRECT-xy (where x and y are two random characters) is added before the Wi-Fi Direct name.
- 2 Type the Wi-Fi Direct password.

Note: Switch your computer back to its previous network after disconnecting from the Wi-Fi Direct network.

Connecting a mobile device to the printer

Before connecting your mobile device, make sure that Wi-Fi Direct has been configured. For more information, see [“Configuring Wi-Fi Direct” on page 12.](#)

Connecting using Wi-Fi Direct

Note: These instructions apply only to Android mobile devices.

- 1 From the mobile device, go to the settings menu.
- 2 Enable **Wi-Fi**, and then tap **Wi-Fi Direct**.
- 3 Select the printer Wi-Fi Direct name.
- 4 Confirm the connection on the printer control panel.

Connecting using Wi-Fi

- 1 From the mobile device, go to the settings menu.
- 2 Tap **Wi-Fi**, and then select the printer Wi-Fi Direct name.

Note: The string DIRECT-xy (where x and y are two random characters) is added before the Wi-Fi Direct name.

- 3 Enter the Wi-Fi Direct password.

Clearing jams

Avoiding jams

Load paper properly

- Make sure that the paper lies flat in the tray.

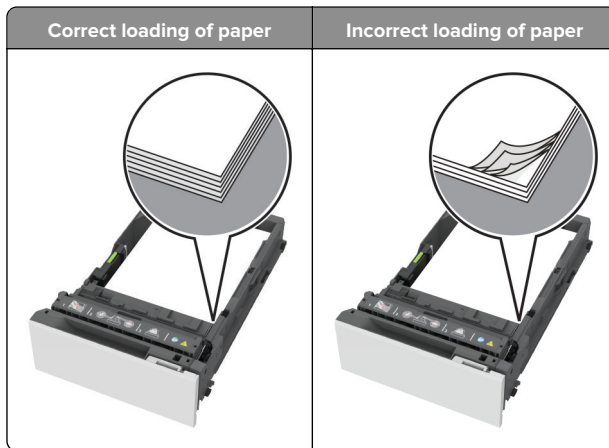

- Do not load or remove a tray while the printer is printing.
- Do not load too much paper. Make sure that the stack height is below the maximum paper fill indicator.

- Do not slide paper into the tray. Load paper as shown in the illustration.

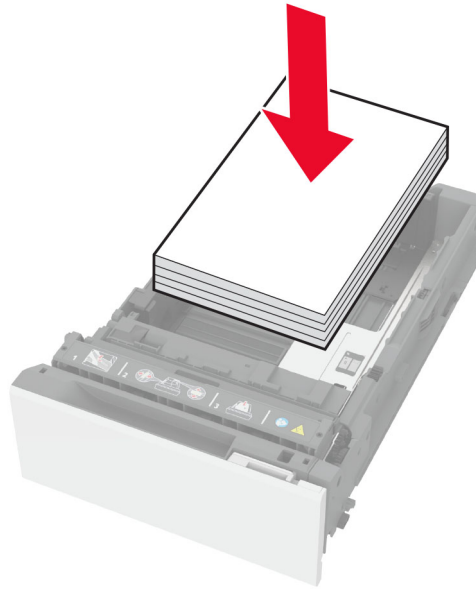

- Make sure that the paper guides are positioned correctly and are not pressing tightly against the paper or envelopes.
- Push the tray firmly into the printer after loading paper.

Use recommended paper

- Use only recommended paper or specialty media.
- Do not load paper that is wrinkled, creased, damp, bent, or curled.
- Flex, fan, and align the paper edges before loading.

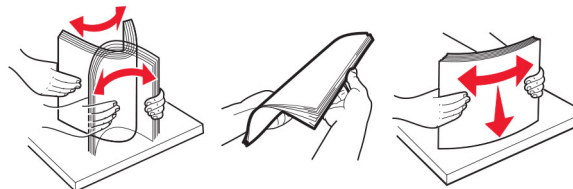

- Do not use paper that has been cut or trimmed by hand.
- Do not mix paper sizes, weights, or types in the same tray.
- Make sure that the paper size and type are set correctly on the computer or printer control panel.

- Store paper according to manufacturer recommendations.

Identifying jam locations

Notes:

- When Jam Assist is set to On, the printer flushes blank pages or pages with partial prints after a jammed page has been cleared. Check your printed output for blank pages.
- When Jam Recovery is set to On or Auto, the printer reprints jammed pages.

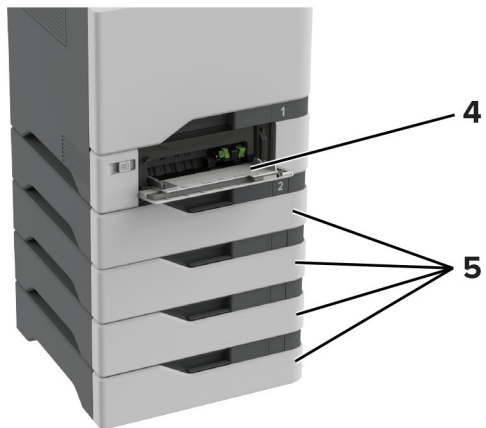
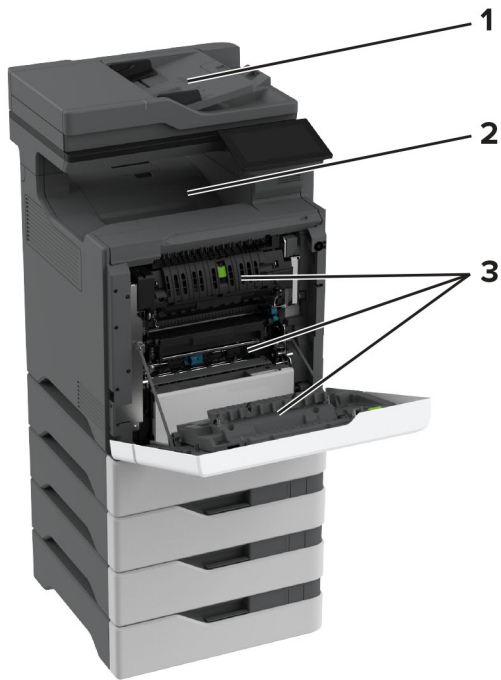

Jam locations	
1	ADF
2	Standard bin

Jam locations	
3	Door A
4	Multipurpose feeder
5	Trays

Paper jam in trays

1 Remove the tray.

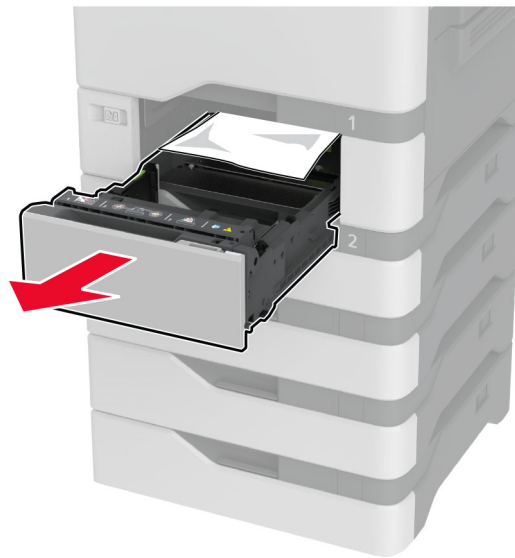

Warning—Potential Damage: A sensor inside the optional tray is easily damaged by static electricity. Touch a metal surface before removing the jammed paper in the tray.

2 Remove the jammed paper.

Note: Make sure that all paper fragments are removed.



3 Insert the tray.

Paper jam in the multipurpose feeder

1 Remove paper from the multipurpose feeder.

2 Pull out the tray.

3 Remove the jammed paper.

Note: Make sure that all paper fragments are removed.

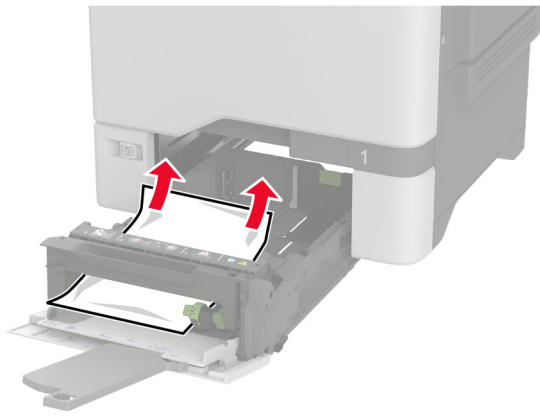

4 Insert the tray.

Paper jam in the standard bin

Remove the jammed paper.

Note: Make sure that all paper fragments are removed.

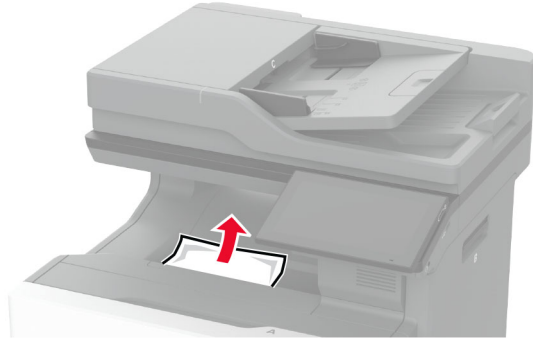

Paper jam in door A

Paper jam in the fuser area

1 Open door A.

 **CAUTION—HOT SURFACE:** The inside of the printer might be hot. To reduce the risk of injury from a hot component, allow the surface to cool before touching it.

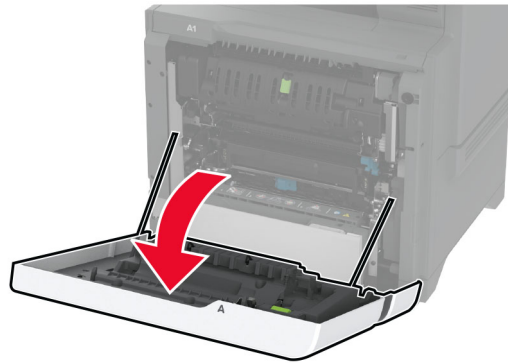

2 Remove the jammed paper.

Note: Make sure that all paper fragments are removed.

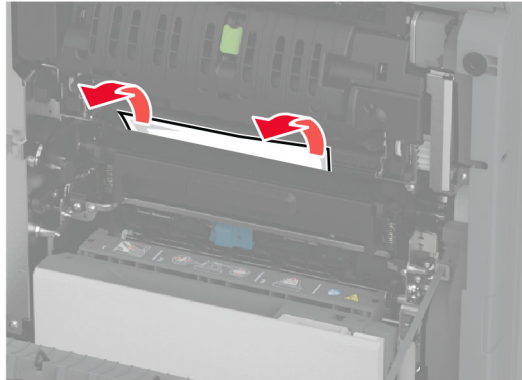

3 Open door A1.



4 Open the fuser access door.

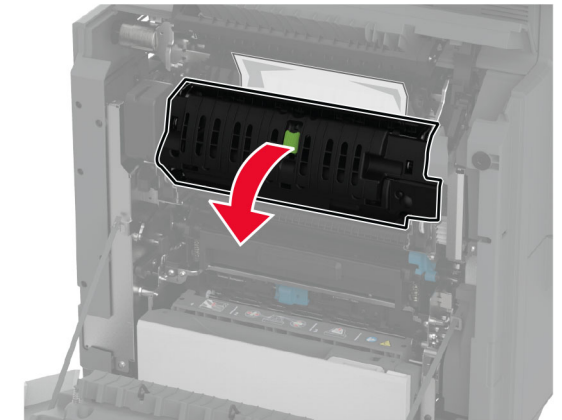

5 Remove the jammed paper.

Note: Make sure that all paper fragments are removed.

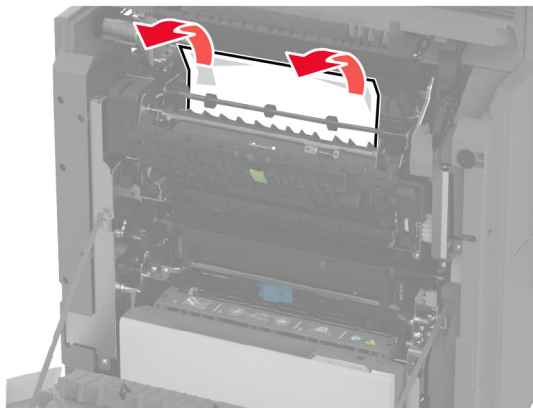

6 Close and latch the fuser access door.

7 Close door A1, and then close door A.

Paper jam behind door A

1 Open door A.

 **CAUTION—HOT SURFACE:** The inside of the printer might be hot. To reduce the risk of injury from a hot component, allow the surface to cool before touching it.

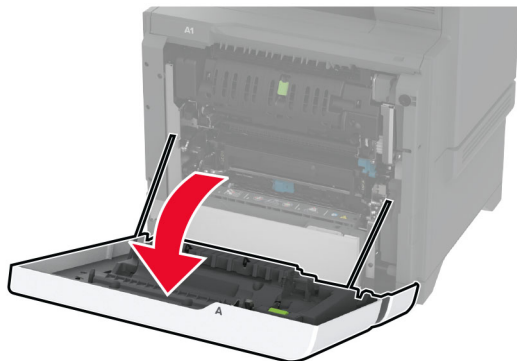

2 Open the isolation unit door.

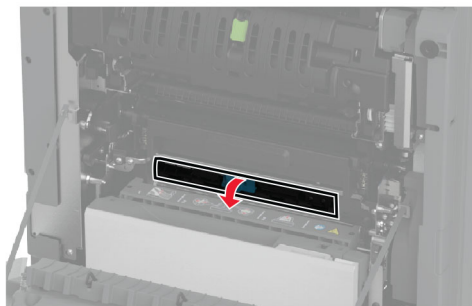
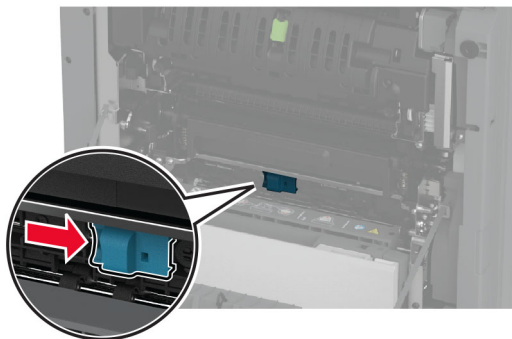

3 Remove the jammed paper.

Note: Make sure that all paper fragments are removed.

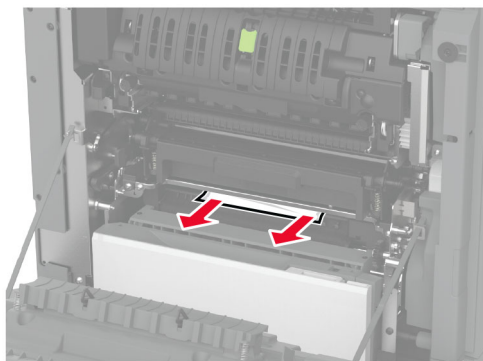

4 Close and latch the isolation unit door.

5 Close door A.

Paper jam in the duplex area

1 Open door A.

 **CAUTION—HOT SURFACE:** The inside of the printer might be hot. To reduce the risk of injury from a hot component, allow the surface to cool before touching it.

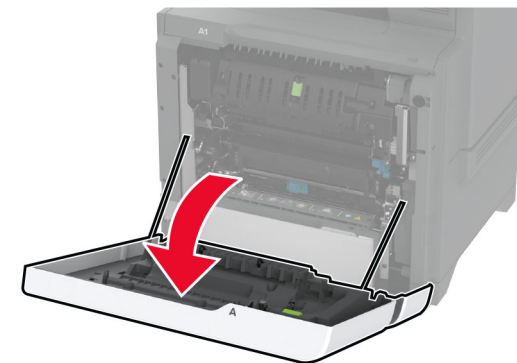

2 Open the duplex cover.

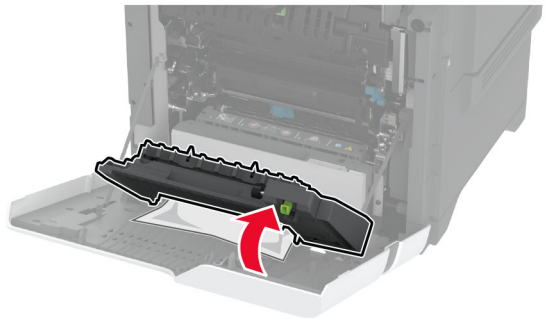
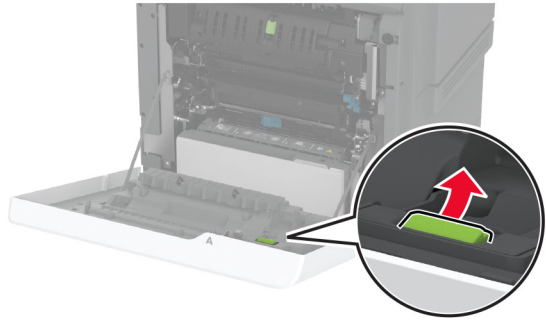

3 Remove the jammed paper.

Note: Make sure that all paper fragments are removed.

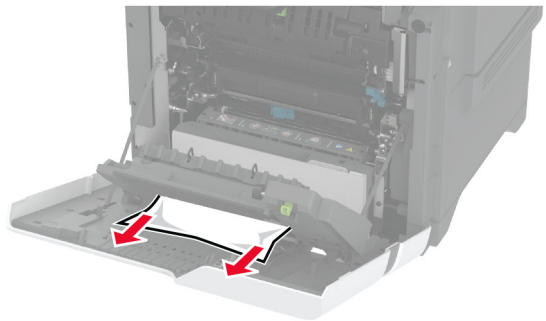

4 Close the duplex cover, and then close door A.

Paper jam in the automatic document feeder

1 Remove all original documents from the ADF tray.

2 Open door C.

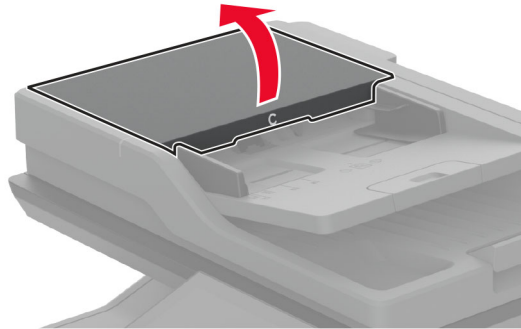

3 Remove the jammed paper.

Note: Make sure that all paper fragments are removed.

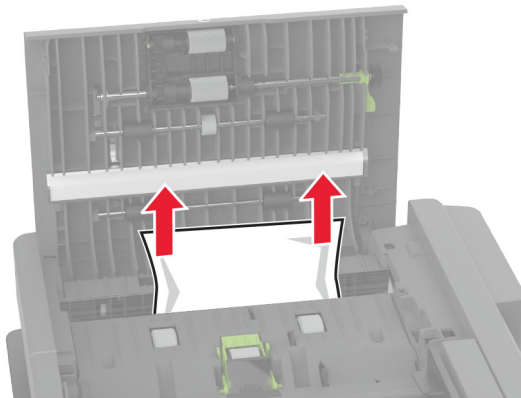

4 Close door C.