



Maintenance and Service Guide

HP Engage One Retail System, Model 141
HP Engage One Retail System, Model 143
HP Engage One Retail System, Model 145

© Copyright 2017, 2018 HP Development Company, L.P.

ENERGY STAR® is a registered mark owned by the U.S. government. Intel, Celeron, and Core are trademarks of Intel Corporation in the United States and/or other countries. Windows is either a registered trademark or trademark of Microsoft Corporation in the United States and/or other countries.

The information contained herein is subject to change without notice. The only warranties for HP products and services are set forth in the express warranty statements accompanying such products and services. Nothing herein should be construed as constituting an additional warranty. HP shall not be liable for technical or editorial errors or omissions contained herein.

Second Edition: August 2018

First Edition: August 2017

Document Part Number: 925670-002

Product notice

This guide describes features that are common to most models. Some features may not be available on your computer.

Software terms

By installing, copying, downloading, or otherwise using any software product preinstalled on this computer, you agree to be bound by the terms of the HP End User License Agreement (EULA). If you do not accept these license terms, your sole remedy is to return the entire unused product (hardware and software) within 14 days for a full refund subject to the refund policy of your seller.

For any further information or to request a full refund of the price of the computer, please contact your seller.

Safety warning notice

 **WARNING!** To reduce the possibility of heat-related injuries or of overheating the device, do not place the device directly on your lap or obstruct the device air vents. Use the device only on a hard, flat surface. Do not allow another hard surface, such as an adjoining optional printer, or a soft surface, such as pillows or rugs or clothing, to block airflow. Also, do not allow the AC adapter to contact the skin or a soft surface, such as pillows or rugs or clothing, during operation. The device and the AC adapter comply with the user-accessible surface temperature limits defined by the International Standard for Safety of Information Technology Equipment (IEC 60950-1).

Table of contents

1 Product overview	1
Standard features	1
Integrated features	3
Stand options	4
HP Engage One Basic I/O Connectivity Base components	4
HP Engage One Advanced I/O Connectivity Base components	5
Connecting an AC adapter to power	6
Locating the Engage One power button	7
Locating the I/O connectivity base power button	7
Adjusting the Engage One head unit	8
Engage One serial number location	9
I/O connectivity base serial number location	9
2 Illustrated parts catalog	10
Computer major components	10
Peripherals	12
Cables and adapters	13
3 Routine care, SATA drive guidelines, and disassembly preparation	14
Computer operating guidelines and routine care	14
Touch screen maintenance	14
MSR maintenance	15
Service considerations	15
Tools and software requirements	15
Screws	15
Cables and connectors	15
Lithium coin cell battery	15
Electrostatic discharge information	16
Generating static	16
Preventing electrostatic damage to equipment	16
Personal grounding methods and equipment	17
Grounding the work area	17
Recommended materials and equipment	18
4 Removal and replacement procedures	19
Preparation for disassembly	19

Attaching an I/O connectivity base to the Engage One	20
Connecting a standalone I/O connectivity base to the Engage One	22
Configuring the I/O connectivity base's powered serial ports	22
Connecting a standalone optional fingerprint reader to the I/O connectivity base	24
Attaching an optional fingerprint reader to the I/O connectivity base	25
Removing and attaching the Engage One head unit to the stand	27
Mounting the Engage One head unit to a wall	28
Mounting the Engage One to a counter top	30
Installing a security cable on the I/O connectivity base	32
Installing a security cable on the Engage One column	33
Installing a security screw on the Engage One head unit and stand	34
Installing a security screw on the Engage One head unit and VESA mount	35
Removing and replacing the column printer	35
Removing the display panel	41
System board components	42
Installing a 2 x 20 customer-facing display (CFD)	43
Memory modules	45
DDR4-SDRAM SODIMMs	45
Removing a SODIMM	45
Removing and installing an M.2 solid-state drive (SSD)	48
Removing the WLAN module	49
Removing the heat sink	51
Removing the fan assembly	52
Removing the speakers	53
Removing the power button board	54
Removing the MSR (Magnetic Stripe Reader)	55
MSR configuration	56
Removing the MSR LED board	58
Removing the system board	59
System board callouts	61
Removing the antennas	62
5 Using the column printer	63
Standard features	63
Printing features	63
When to change the receipt paper	64
Loading the printer receipt paper	64
Thermal paper specifications	65
Qualified paper grades	65
Troubleshooting the printer	66
Printer tone and green LED	67

Printing issues	67
Printer does not function	68
Latch failsafe	69
Cleaning the printer	69
6 Cable routing configurations	70
Cable matrix for Engage One with integrated column printer and basic I/O connectivity base	70
Cable matrix for Engage One with integrated column printer and advanced I/O connectivity base	71
Cable matrix for Engage One without I/O connectivity base	72
Cable matrix for Engage One with I/O connectivity base	73
Cable matrix for Engage One with basic I/O connectivity base and standalone printer	74
Cable matrix for Engage One with advanced I/O connectivity base and standalone printer	75
7 Configuring the software	76
Touch screen calibration for Windows 10 Professional and Windows 10 IoT Enterprise for Retail	76
Configuring optional HP integrated peripheral modules	76
8 Computer Setup (F10) Utility	77
Computer Setup (F10) Utilities	77
Using Computer Setup (F10) Utilities	77
Computer Setup—Main	79
Computer Setup—Security	81
Computer Setup—Advanced	83
Recovering the Configuration Settings	87
9 POST error messages and diagnostic front panel LEDs and audible codes	88
POST numeric codes and text messages	88
Interpreting system validation diagnostic front panel LEDs and audible codes	93
10 Password security and resetting CMOS	95
Resetting the password jumper	95
Changing a Setup or Power-On password	96
Deleting a Setup or Power-On password	97
Clearing and resetting the CMOS	97
11 Using HP PC Hardware Diagnostics (UEFI)	99
Downloading HP PC Hardware Diagnostics (UEFI) to a USB device	99
Using Remote HP PC Hardware Diagnostics (UEFI) settings (select products only)	100
Customizing Remote HP PC Hardware Diagnostics (UEFI) settings	100

12 Troubleshooting without diagnostics	101
Safety and comfort	101
Before you call for technical support	101
Helpful hints	102
Solving retail system-specific problems	103
Solving general problems	104
Solving printer problems	108
Solving hardware installation problems	109
Solving network problems	110
Solving memory problems	112
Solving USB flash drive problems	114
Solving Internet access problems	114
Solving software problems	116
13 System backup and recovery	117
Backing up, restoring, and recovering in Windows 10	117
Creating recovery media and backups	117
Creating HP Recovery media (select products only)	117
Using Windows tools	119
Restore and recovery	119
Recovering using HP Recovery Manager	119
What you need to know before you get started	119
Using the HP Recovery partition (select products only)	120
Using HP Recovery media to recover	120
Changing the computer boot order	121
Removing the HP Recovery partition (select products only)	121
Appendix A Power cord set requirements	122
General requirements	122
Japanese power cord requirements	122
Country-specific requirements	123
Appendix B Statement of memory volatility	124
Nonvolatile memory usage	126
Questions and answers	128
Using HP Sure Start (select models only)	129
Appendix C Specifications	130
Index	132

1 Product overview

Standard features



The HP Engage One Retail System is designed for long-term deployment within general retail, hospitality, and other markets. It includes the following features:

- Integrated All-in-One (AiO) form factor
- 14-inch diagonal display panel (wide-aspect ratio); FHD 1920 x 1080 resolution, sealed and chemically hardened, anti-glare; anti-smudge
- Model 141: anti-glare WLED SVA 300-nit panel with FHD 1920 x 1080 resolution and an Intel® Celeron® 3965U 2.2 GHz 2M 2133 2C6 processor
- Model 143: anti-glare WLED UWVA 500-nit panel with FHD 1920 x 1080 resolution and an Intel® Core™ i3 - 7100U 2.40 GHz 3M 2133 2C6 processor
- Model 145: anti-glare WLED UWVA 500-nit panel with FHD 1920 x 1080 resolution and an Intel® i5 - 7300U 2.60 GHz 3MB 2133 2C6 processor



NOTE: Nits is the measure of the typical brightness of the panel as specified, prior to anti-glare coating.

- Optional 100 mm x 100 mm VESA mounting bracket
- Optional counter top mounting bracket
- Choice of a rotate/tilt stand with a 10° tilt range and 180° swivel capability, or a fixed position stand
- Optional HP peripherals:
 - HP Engage One integrated magnetic strip reader (MSR) (integrated into the head unit as configure to order)
 - HP Engage One integrated 2 x 20 LCD customer-facing display (CFD), top mount
 - HP Engage One integrated column printer or standalone printer
 - HP Engage One 2D barcode scanner
 - HP Engage One biometric fingerprint reader

- DDR4 2400 MHz memory with up to 32 GB RAM
- Operating system choices:
 - Windows® 10 IoT Enterprise 2016 LTSB 64-bit
 - Windows 10 Professional 64-bit
 - FreeDOS 2.0
- HP Engage One Advanced I/O Connectivity Base (optional)
 - 2 powered serial ports (0 V, 5 V, 12 V)
 - (2) 12 V powered USB ports
 - (1) 24 V powered USB port
 - 4 USB 3.0 ports
 - 1 cash drawer jack
 - 1 RJ-45 network jack
 - 1 video-out USB Type-C port
- HP Engage One Basic I/O Connectivity Base (optional)
 - 3 powered serial ports (0 V, 5 V, 12 V)
 - 4 USB 2.0 ports
 - 2 USB 3.0 ports
 - 1 cash drawer jack
 - 1 RJ-45 network jack
 - 1 video out USB Type-C port
- One internal SD card reader on the computer head unit and one external microSD card reader on the I/O connectivity base
- Universal audio jack with CTIA headset support on the I/O connectivity base
- One M.2 SSD internal drive on the computer head unit
- ENERGY STAR® compliant

Integrated features

The integrated devices shown below are optional.



Features

(1) 14-inch diagonal display panel (wide-aspect ratio); FHD 1920 x 1080 resolution, sealed and chemically hardened, anti-glare; anti-smudge	(4) HP Engage One 2 x 20 Customer-facing Display (CFD)
(2) HP Engage One Integrated Column Printer	(5) HP Engage One Integrated MSR
(3) Choice of 2 Engage One I/O Connectivity Bases	(6) HP Engage One Biometric Fingerprint Reader

Display panel options:

- Anti-glare WLED SVA 300 nits panel
- Anti-glare WLED UWVA 500 nits panel

NOTE: Nits is the measure of the typical brightness of the panel as specified, prior to anti-glare coating.

Stand options



Options

- (1) HP Engage One Rotate/Tilt Stand with Integrated Column Printer
- (2) HP Engage One Rotate/Tilt Stand
- (3) HP Engage One Fixed Position Stand

NOTE: The stands are shown on a stability base.

HP Engage One Basic I/O Connectivity Base components

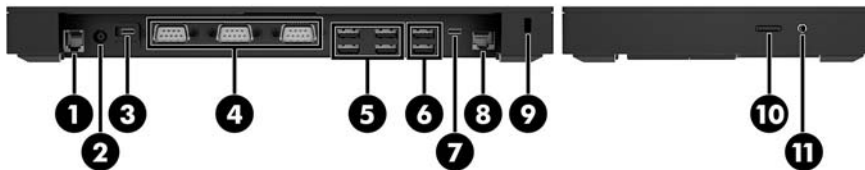

Basic components

- | | |
|------------------------------|--------------------------|
| (1) Cash drawer jack | (7) USB Type-C port |
| (2) Power connector | (8) RJ-45 network jack |
| (3) USB Type-C power port | (9) Security cable slot |
| (4) Powered serial ports (3) | (10) MicroSD card reader |
| (5) USB 2.0 ports (4) | (11) Headset jack |
| (6) USB 3.0 ports (2) | |

IMPORTANT: To avoid damage to the computer, DO NOT plug a telephone cable into the cash drawer jack.

HP Engage One Advanced I/O Connectivity Base components

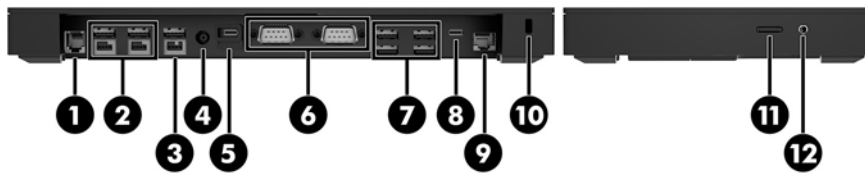

Advanced components

(1) Cash drawer jack	(7) USB 3.0 ports (4)
(2) Powered USB 12 V ports (2)	(8) USB Type-C port
(3) Powered USB 24 V port	(9) RJ-45 network jack
(4) Power connector	(10) Security cable slot
(5) USB Type-C power port	(11) MicroSD card reader
(6) Powered serial ports (2)	(12) Headset jack

IMPORTANT: To avoid damage to the computer, DO NOT plug a telephone cable into the cash drawer jack.

Connecting an AC adapter to power

To connect an AC adapter to the I/O connectivity base, connect one end of the power cord to the AC adapter (1) and the other end to a grounded AC outlet (2), and then connect the AC adapter to the power connector on the I/O connectivity base (3).

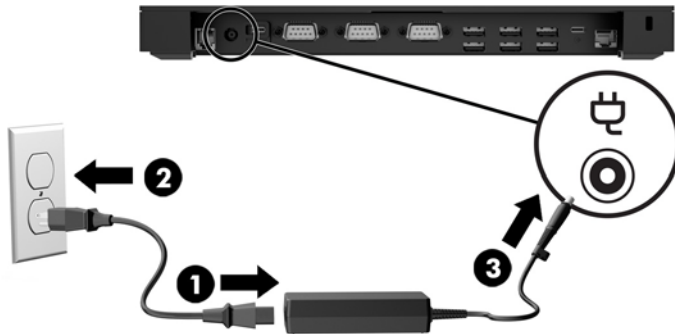

To connect an AC adapter to the computer when it is not connected to an I/O connectivity base, connect the AC adapter to a grounded AC outlet (1), and then connect the power adapter's USB Type-C connector to the USB Type-C power port on the underside of the stand or stability base (2).

 **NOTE:** The image below is shown with a stability base.

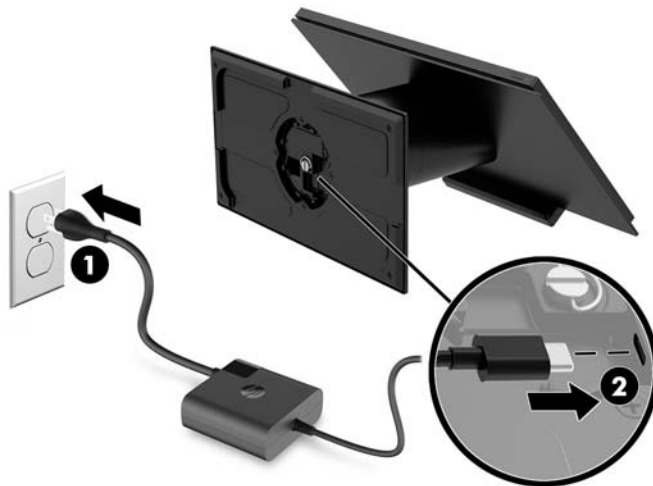

Locating the Engage One power button

The computer power button is located on the bottom right edge of the bezel.

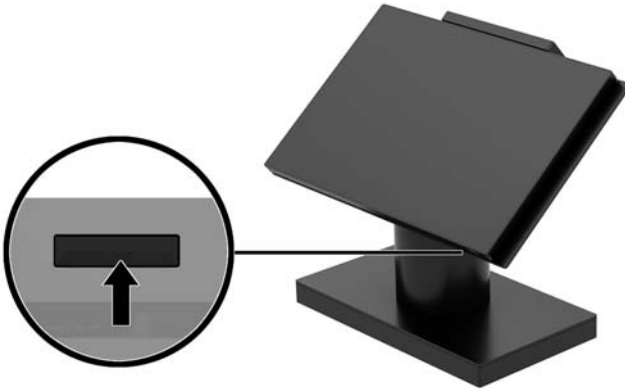

Locating the I/O connectivity base power button

The I/O connectivity base power button is located on the underside of the I/O connectivity base.

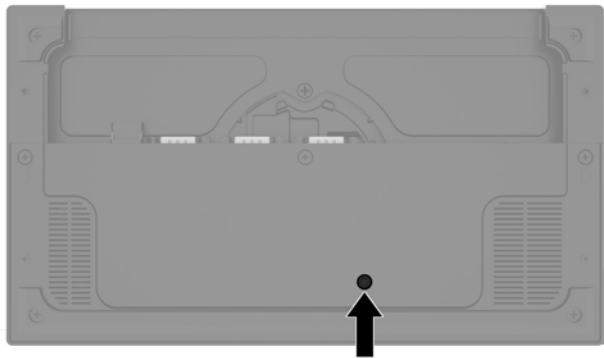

The head unit controls the I/O connectivity base. When the head unit is turned off, the I/O connectivity base is turned off and power is not available from the I/O connectivity base ports. The exception is the I/O connectivity base's USB Type-C port that connects to the head unit. That port will remain powered so that it can continue to communicate with the head unit and allow the I/O connectivity base to turn back on when the head unit is turned on.

After the system has been turned off, you can press the power button on the underside of the I/O connectivity base to allow power to be available on the I/O connectivity base ports while the head unit remains turned off.

Adjusting the Engage One head unit

 **NOTE:** The tilt and swivel features are only available on performance stands.

You can tilt and swivel the computer head to set it to a comfortable viewing angle. There is a 10° tilt range that can be set between 50° and 60°.

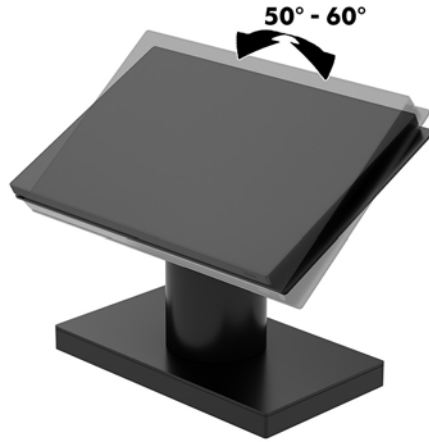

The computer head unit can be swiveled 180° in either direction.

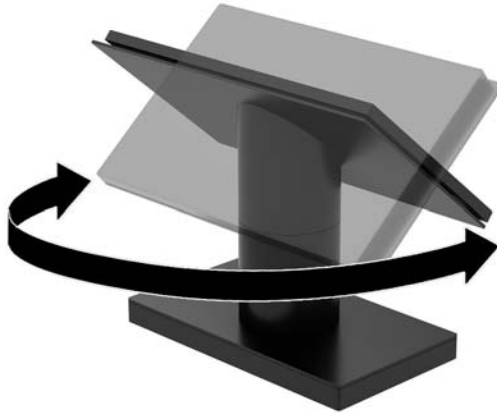

Engage One serial number location

Each computer has a unique serial number and a product ID number that are located on the exterior of the computer. Keep these numbers available for use when contacting customer service for assistance.

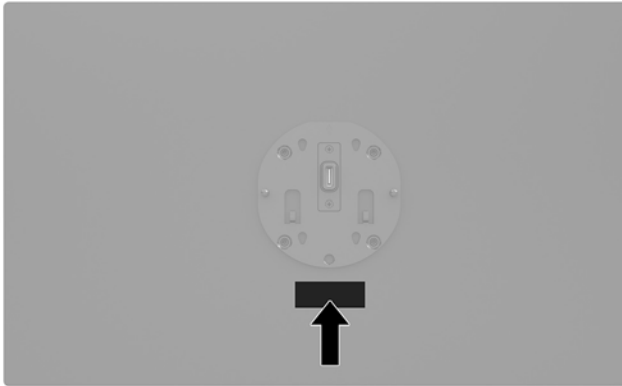

I/O connectivity base serial number location

Each I/O connectivity base has a unique serial number and a product ID number that are located on the exterior of the I/O connectivity base. Keep these numbers available for use when contacting customer service for assistance.

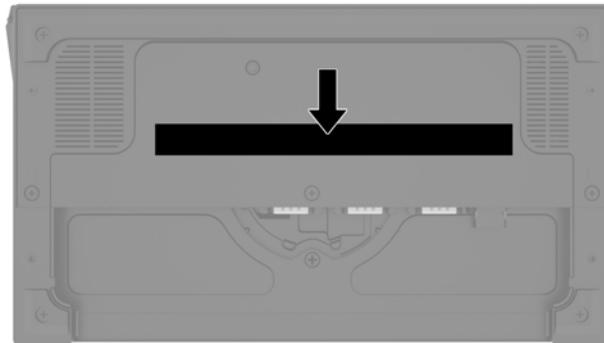

Regulatory information is located in the base plate or wall mount. Install the base plate or wall mount back after disassembly.

2 Illustrated parts catalog

 **NOTE:** HP continually improves and changes product parts. For complete and current information on supported parts for your computer, go to <http://partsurfer.hp.com>, select your country or region, and then follow the on-screen instructions.

Computer major components

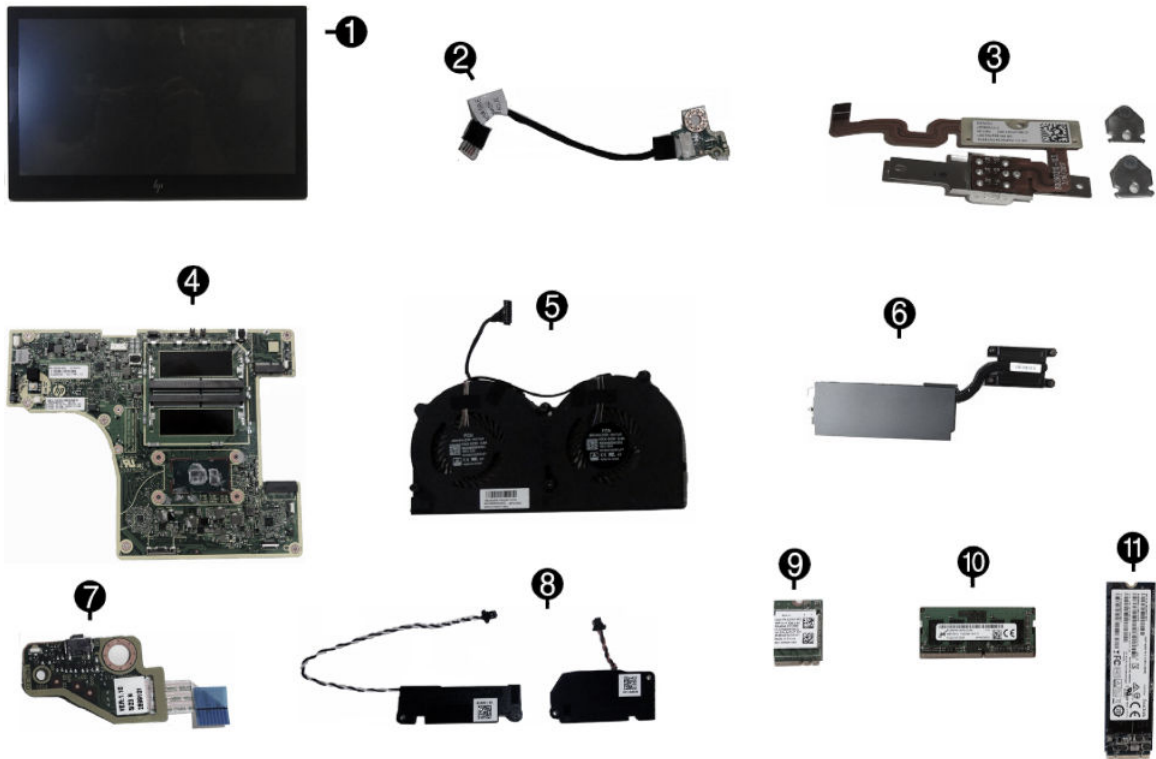

Item	Description
(*)	Whole unit (not illustrated)
(1)	Display panel
	Touch, 500 nits
	Touch, 300 nits
(2)	MSR LED board and cable
(3)	MSR board and cable
(4)	System board (includes replacement thermal material)
	Includes embedded Intel Core i5-7300U processor
	Includes embedded Intel Core i3-7100U processor
	Includes embedded Intel Celeron 3965U processor

Item	Description
(5)	Fan assembly
(6)	Heat sink
	For use in models with 500 nit displays
	For use in models with 300 nit displays
(7)	Power button board
(8)	Speakers, left and right
(9)	WLAN module
	Intel Dual Band Wireless-AC 8265 (vPro)
	Intel Dual Band Wireless-AC 8265 (non-vPro)
	Realtek RTL8723BE-VB 802.11 bgn 1x1 Wi-Fi + BT4.0 Combo Adapter
(10)	Memory modules (SODIMM, DDR4-2400)
	16 GB
	8 GB
	4 GB
(11)	Solid state drives (NVMe)
	1 TB, TLC
	512 GB, PCIe
	512 GB, TLC, PCIe
	512 GB, value, PCIe
	512 GB, SATA-3, TLC
	256 GB, TLC, PCIe
	256 GB, value, PCIe
	256 GB, SATA-3, TLC
	128 GB, PCIe
	128 GB, SATA-3, TLC
*	Power supply, external
	180 W
	120 W
	65 W, USB Type-C
*	Stand, fixed position
*	Stand, rotate/tilt
*	Thumb screw, stand base
*	Security locking screw
*	Printer external power supply

Item	Description
*	Table Mount Kit
*	VESA wall mount
*	Backplate guide

* not illustrated

Peripherals



	Description
(1)	HP Engage One Serial USB Thermal Printer
(2)	HP Engage One 2D Barcode Scanner
(3)	HP Engage One Fingerprint Reader
(4)	HP Engage One Top Mount 2x20 CFD
	HP L8010t 10.1" Touch CFD
	HP L8010 10.1" Non-Touch CFD
(5)	HP Engage One Column Printer, black or white
(6)	I/O Connectivity Base
	Advanced (includes powered USBs)
	Basic (does not include powered USBs)

Cables and adapters

Description
Touch cable, 300/500nits
WLAN antenna cables
Printer serial cable
Printer USB cable
Fingerprint reader cable, USB Type-A to micro USB, 0.3 meter
Fingerprint reader cable, USB Type-A to micro USB, 1.8 meter
Column printer cable, 2 meter, 24V powered USB
Column printer cable, 26 cm, 24V powered USB
Column printer cable, 2 meter, USB Type-B to Type-A
Column printer cable, 23 cm, USB Type-B to Type-A
Column printer cable, 50 cm, cash drawer
24V to Y (Hosiden/Type-B), powered USB cable (for use with HP POS Hybrid Printer, MICR with Imaging Module)
24V powered USB cable (power only), Hosiden
USB Type-C cable, coiled
USB Type-C cable, straight
USB Type-C cable, 20V/3A, 0.43 meter
USB Type-C cable, 20V/3A, 1.8 meter
USB Type-C cable, VESA
USB Type-C cable connector restraint kit
Adapters
USB to serial
USB Type-C to VGA
USB Type-C to DisplayPort
USB Type-C to HDMI

3 Routine care, SATA drive guidelines, and disassembly preparation

This chapter provides general service information for the computer. Adherence to the procedures and precautions described in this chapter is essential for proper service.

 **CAUTION:** When the computer is plugged into an AC power source, voltage is always applied to the system board. You must disconnect the power cord from the power source before opening the computer to prevent system board or component damage.

Computer operating guidelines and routine care

Follow the guidelines below to properly set up and care for the computer:

- HP recommends a 17 mm clearance around the vents on the computer head unit and I/O connectivity base for heat dissipation.
- Keep the computer away from excessive moisture, direct sunlight, and extremes of heat and cold.
- Never operate the computer with any access panels removed.
- Do not stack computers on top of each other or place computers so near each other that they are subject to each other's recirculated or preheated air.
- If the computer is to be operated within a separate enclosure, intake and exhaust ventilation must be provided on the enclosure, and the same operating guidelines listed above will still apply.
- Keep liquids away from the computer and I/O connectivity base.
- Never cover the vents on the computer or I/O connectivity base with any type of material.
- Install or enable power management functions of the operating system or other software, including sleep states.
- Turn off the computer before you do either of the following:
 - Wipe the exterior of the computer with a soft, damp cloth as needed. Using cleaning products may discolor or damage the finish.
 - Occasionally clean the air vents on all vented sides of the computer. Lint, dust, and other foreign matter can block the vents and limit the airflow.

 **NOTE:** For more information on your retail system care and maintenance, refer to “Retail Point of Sales Systems - Routine Care and Maintenance” available at <http://www.hp.com/support>.

Touch screen maintenance

Keep your display and touch sensor clean. The touch sensor requires very little maintenance. HP recommends that you periodically clean the glass touch sensor surface. Be sure to turn off your display before cleaning. Typically, an isopropyl alcohol and water solution ratio of 50:50 is the best cleaning agent for your touch sensor. It is important to avoid using any caustic chemicals on the touch sensor. Do not use any vinegar-based solutions.

Apply the cleaner with a soft, lint-free cloth. Avoid using gritty cloths. Always dampen the cloth and then clean the sensor. Be sure to spray the cleaning liquid onto the cloth, not the sensor, so that drips do not seep inside the display or stain the bezel.

MSR maintenance

To clean the MSR (magnetic strip reader), swipe a standard cleaning card through the MSR a couple of times. You can order a standard cleaning card online. You can also put a thin oil-free cloth around a credit card.

Service considerations

Listed below are some of the considerations that you should keep in mind during the disassembly and assembly of the computer.

Tools and software requirements

To service the computer, you need the following:

- Torx T-15 screwdriver
- Flat-bladed screwdriver (may sometimes be used in place of the Torx screwdriver)
- Phillips #2 screwdriver
- Phillips #1 screwdriver
- Diagnostics software
- Tamper-resistant T-10 screwdriver

Screws

The screws used in the computer are not interchangeable. They may have standard or metric threads and may be of different lengths. If an incorrect screw is used during the reassembly process, it can damage the unit. HP strongly recommends that all screws removed during disassembly be kept with the part that was removed, then returned to their proper locations.

⚠ CAUTION: As each subassembly is removed from the computer, it should be placed away from the work area to prevent damage.

Cables and connectors

Most cables used throughout the unit are flat, flexible cables. These cables must be handled with care to avoid damage. Apply only the tension required to seat or unseat the cables during insertion or removal from the connector. Handle cables by the connector whenever possible. In all cases, avoid bending or twisting the cables, and ensure that the cables are routed in such a way that they cannot be caught or snagged by parts being removed or replaced.

⚠ CAUTION: When servicing this computer, ensure that cables are placed in their proper location during the reassembly process. Improper cable placement can damage the computer.

Lithium coin cell battery

The battery that comes with the computer provides power to the real-time clock and has a minimum lifetime of about three years.

See the appropriate removal and replacement chapter for the chassis you are working on in this guide for instructions on the replacement procedures.

 **WARNING!** This computer contains a lithium battery. There is a risk of fire and chemical burn if the battery is handled improperly. Do not disassemble, crush, puncture, short external contacts, dispose in water or fire, or expose it to temperatures higher than 140°F (60°C). Do not attempt to recharge the battery.

 **NOTE:** Batteries, battery packs, and accumulators should not be disposed of together with the general household waste. In order to forward them to recycling or proper disposal, please use the public collection system or return them to HP, their authorized partners, or their agents.

Electrostatic discharge information

A sudden discharge of static electricity from your finger or other conductor can destroy static-sensitive devices or microcircuitry. Often the spark is neither felt nor heard, but damage occurs. An electronic device exposed to electrostatic discharge (ESD) may not appear to be affected at all and can work perfectly throughout a normal cycle. The device may function normally for a while, but it has been degraded in the internal layers, reducing its life expectancy.

Networks built into many integrated circuits provide some protection, but in many cases, the discharge contains enough power to alter device parameters or melt silicon junctions.

Generating static

The following table shows that:

- Different activities generate different amounts of static electricity.
- Static electricity increases as humidity decreases.

Event	Relative Humidity		
	55%	40%	10%
Walking across carpet	7,500 V	15,000 V	35,000 V
Walking across vinyl floor	3,000 V	5,000 V	12,000 V
Motions of bench worker	400 V	800 V	6,000 V
Removing DIPs from plastic tube	400 V	700 V	2,000 V
Removing DIPs from vinyl tray	2,000 V	4,000 V	11,500 V
Removing DIPs from Styrofoam	3,500 V	5,000 V	14,500 V
Removing bubble pack from PCB	7,000 V	20,000 V	26,500 V
Packing PCBs in foam-lined box	5,000 V	11,000 V	21,000 V

These are then multi-packaged inside plastic tubes, trays, or Styrofoam.

 **NOTE:** 700 volts can degrade a product.

Preventing electrostatic damage to equipment

Many electronic components are sensitive to ESD. Circuitry design and structure determine the degree of sensitivity. The following packaging and grounding precautions are necessary to prevent damage to electric components and accessories.

- To avoid hand contact, transport products in static-safe containers such as tubes, bags, or boxes.
- Protect all electrostatic parts and assemblies with conductive or approved containers or packaging.
- Keep electrostatic sensitive parts in their containers until they arrive at static-free stations.
- Place items on a grounded surface before removing them from their container.
- Always be properly grounded when touching a sensitive component or assembly.
- Avoid contact with pins, leads, or circuitry.
- Place reusable electrostatic-sensitive parts from assemblies in protective packaging or conductive foam.

Personal grounding methods and equipment

Use the following equipment to prevent static electricity damage to equipment:

- **Wrist straps** are flexible straps with a maximum of one-megohm \pm 10% resistance in the ground cords. To provide proper ground, a strap must be worn snug against bare skin. The ground cord must be connected and fit snugly into the banana plug connector on the grounding mat or workstation.
- **Heel straps/Toe straps/Boot straps** can be used at standing workstations and are compatible with most types of shoes or boots. On conductive floors or dissipative floor mats, use them on both feet with a maximum of one-megohm \pm 10% resistance between the operator and ground.

Static Shielding Protection Levels

Method	Voltage
Antistatic plastic	1,500
Carbon-loaded plastic	7,500
Metallized laminate	15,000

Grounding the work area

To prevent static damage at the work area, use the following precautions:

- Cover the work surface with approved static-dissipative material. Provide a wrist strap connected to the work surface and properly grounded tools and equipment.
- Use static-dissipative mats, foot straps, or air ionizers to give added protection.
- Handle electrostatic sensitive components, parts, and assemblies by the case or PCB laminate. Handle them only at static-free work areas.
- Turn off power and input signals before inserting and removing connectors or test equipment.
- Use fixtures made of static-safe materials when fixtures must directly contact dissipative surfaces.
- Keep work area free of nonconductive materials such as ordinary plastic assembly aids and Styrofoam.
- Use field service tools, such as cutters, screwdrivers, and vacuums, that are conductive.

Recommended materials and equipment

Materials and equipment that are recommended for use in preventing static electricity include:

- Antistatic tape
- Antistatic smocks, aprons, or sleeve protectors
- Conductive bins and other assembly or soldering aids
- Conductive foam
- Conductive tabletop workstations with ground cord of one-megohm +/- 10% resistance
- Static-dissipative table or floor mats with hard tie to ground
- Field service kits
- Static awareness labels
- Wrist straps and footwear straps providing one-megohm +/- 10% resistance
- Material handling packages
- Conductive plastic bags
- Conductive plastic tubes
- Conductive tote boxes
- Opaque shielding bags
- Transparent metallized shielding bags
- Transparent shielding tubes

4 Removal and replacement procedures

 **NOTE:** HP continually improves and changes product parts. For complete and current information on supported parts for your computer, go to <http://partsurfer.hp.com>, select your country or region, and then follow the on-screen instructions.

Adherence to the procedures and precautions described in this chapter is essential for proper service. After completing all necessary removal and replacement procedures, run the Diagnostics utility to verify that all components operate properly.

 **NOTE:** Not all features listed in this guide are available on all computers.

Preparation for disassembly

See [Routine care, SATA drive guidelines, and disassembly preparation on page 14](#) for initial safety procedures.

1. Remove/disengage any security devices that prohibit opening the computer.
2. Shut down the computer properly through the operating system, then turn off any external devices.
3. Disconnect the power cord from the power outlet.

 **CAUTION:** Regardless of the power-on state, voltage is always present on the system board as long as the system is plugged into an active AC outlet. You must disconnect the power cord and wait approximately 30 seconds for the power to drain to avoid damage to the internal components of the computer.

4. Disconnect all cables from the rear I/O connectors.

 **CAUTION:** The screws used in the computer are of different thread sizes and lengths; using the wrong screw in an application may damage the unit.

 **NOTE:** During disassembly, label each cable as you remove it, noting its position and routing. Keep all screws with the units removed.

Attaching an I/O connectivity base to the Engage One

You can attach an I/O connectivity base to the bottom of the computer's stand.

1. Prepare the computer for disassembly ([Preparation for disassembly on page 19](#)).
2. Remove the cover on the I/O connectivity base by removing the four screws on the underside of the I/O connectivity base (1), and then lifting the cover off the I/O connectivity base (2).

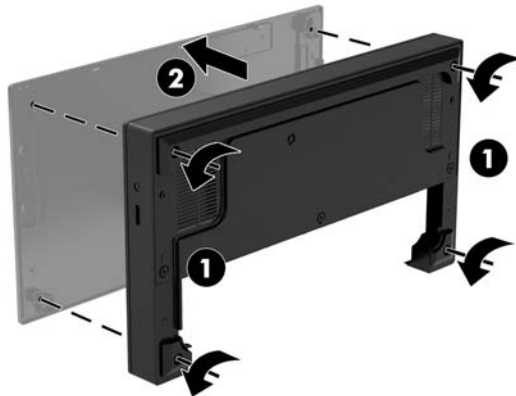

3. Connect the USB Type-C power cable to the USB Type-C port on the underside of the stand's column.

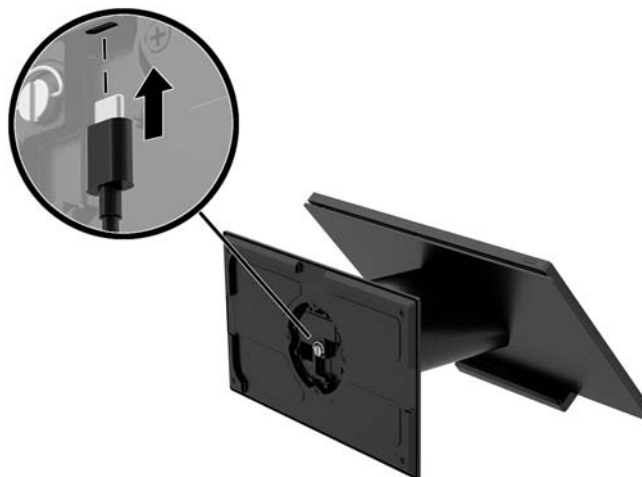

4. Place the I/O connectivity base onto the bottom of the stand (1), and then tighten the four screws on the underside of the I/O connectivity base (2) to secure the I/O connectivity base to the stand. Be sure that the USB Type-C power cable is routed through the gap between the back of the I/O connectivity base and the stand.

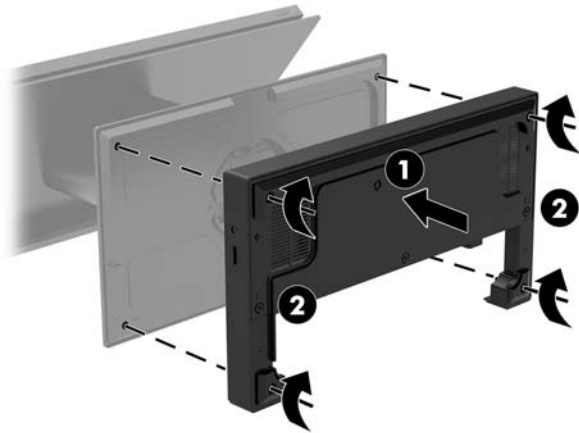

5. To connect and secure the USB Type-C power cable, attach the cable clip to the cable (1), insert the cable tie into the hole (2) below the USB Type-C port on the hub, and then slide the cable clip onto the cable tie and connect the cable to the port (3).

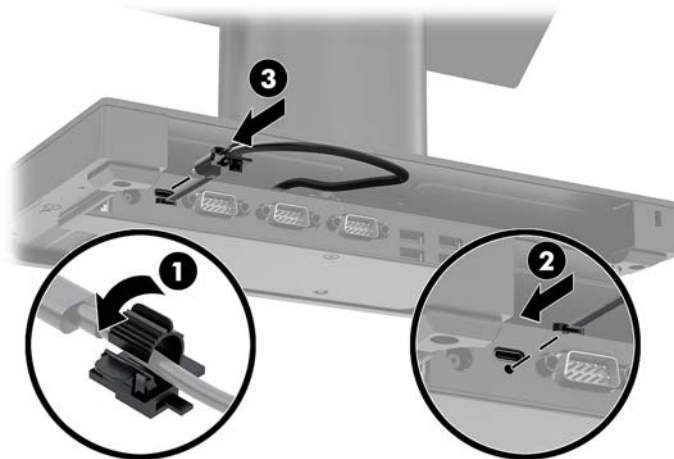

6. Connect the I/O connectivity base's AC adapter to the I/O connectivity base and a grounded AC outlet.

Connecting a standalone I/O connectivity base to the Engage One

1. Prepare the computer for disassembly ([Preparation for disassembly on page 19](#)).
2. Connect the USB Type-C power cable to the USB Type-C port on the underside of the stand's column and to the USB Type-C power port on the I/O connectivity base.

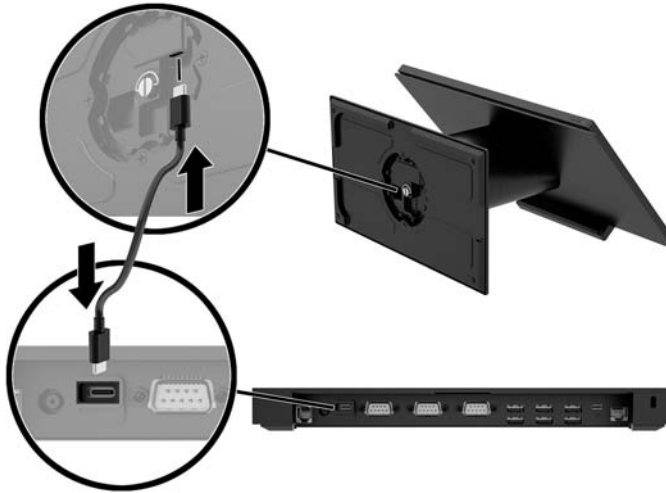

3. Connect the I/O connectivity base's power supply to the I/O connectivity base and a grounded AC outlet.

Configuring the I/O connectivity base's powered serial ports

The serial ports can be configured as standard (non-powered) serial ports or powered serial ports. Some devices use a powered serial port. If the serial port is configured as a powered port, devices that support a powered serial interface do not require an external power source.

IMPORTANT: The system must be powered off before connecting or disconnecting serial port devices.

NOTE: The I/O connectivity base ships with all serial ports configured in standard non-powered serial mode (0 volts) by default.

There are three voltage settings for each serial port.

- 0 volts
- 5 volts
- 12 volts

To change the voltage settings for a powered serial port:

1. Prepare the computer for disassembly ([Preparation for disassembly on page 19](#)).

2. Remove the five screws on the underside of the I/O connectivity base (1) that secure the bottom plate to the I/O connectivity base, and then remove the bottom plate from the I/O connectivity base (2).

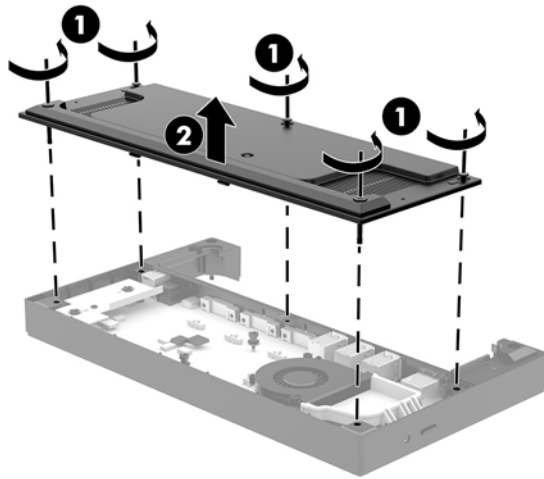

3. Adjust the voltage select switch behind each serial port to the desired setting.

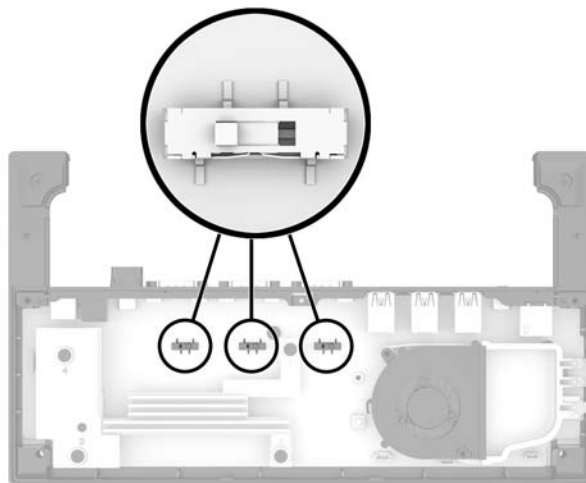

4. Place the bottom plate onto the I/O connectivity base (1), and then secure the plate to the I/O connectivity base with the five screws (2).

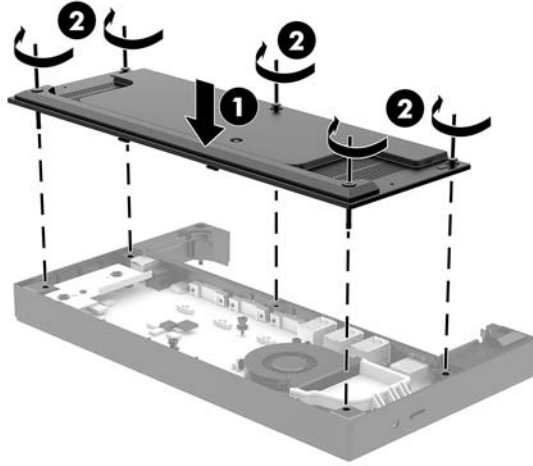

5. Reconnect the I/O connectivity base's power cord and peripheral devices.

Connecting a standalone optional fingerprint reader to the I/O connectivity base

The optional fingerprint reader can be used as a standalone device or it can be attached to the I/O connectivity base. Follow the procedure below to connect a standalone fingerprint reader to the I/O connectivity base.

1. Prepare the computer for disassembly ([Preparation for disassembly on page 19](#)).
2. Connect the USB cable to the fingerprint reader (1) and route the cable through the routing channel (2) on the fingerprint reader.

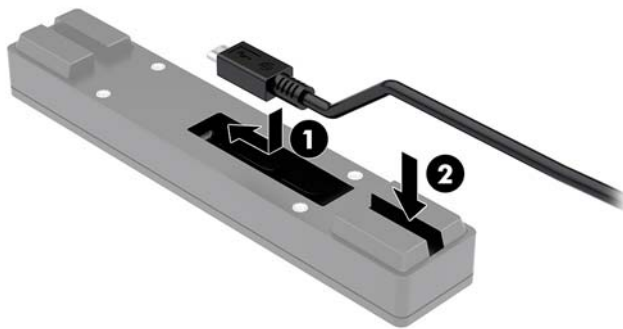

3. Connect the fingerprint reader USB cable to a USB Type-A port on the I/O connectivity base.



4. Reconnect the I/O connectivity base and computer power cords.

Attaching an optional fingerprint reader to the I/O connectivity base

The optional fingerprint reader can be used as a standalone device or it can be attached to the I/O connectivity base. Follow the procedure below to attach the fingerprint reader to the I/O connectivity base.

 **NOTE:** You can attach the fingerprint reader to either side of the I/O connectivity base, but if you attach it to the left side of the I/O connectivity base, the fingerprint reader will cover the microSD slot and the headset jack on the I/O connectivity base.

1. Prepare the computer for disassembly ([Preparation for disassembly on page 19](#)).
2. Place the fingerprint reader (1) on the riser (2), and then attach the mounting bracket (3) and cable routing clip (4) to the fingerprint reader and riser with the two long screws (5) included with the fingerprint reader.

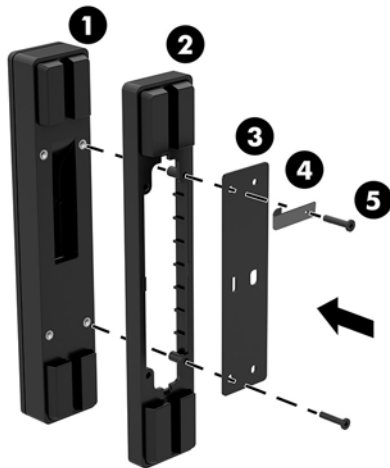

3. Connect the USB cable to the fingerprint reader (1) and route the cable under the routing clip on the fingerprint reader (2). Remove the mounting screw (3) from the underside of the I/O connectivity base, and then attach the bracket on the fingerprint reader assembly to the underside of the I/O connectivity base (4) using the screw that was removed from the base and the short screw included in the kit.

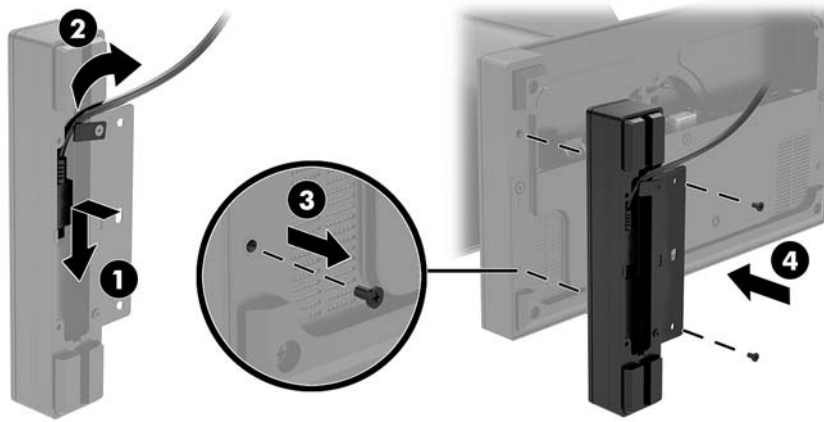

4. Connect the fingerprint reader cable to a USB Type-A port on the I/O connectivity base.



5. Reconnect the I/O connectivity base and computer power cords.

Removing and attaching the Engage One head unit to the stand

1. Prepare the computer for disassembly ([Preparation for disassembly on page 19](#)).
2. Insert a thin metal tool, such as a screwdriver, into the computer head unit release hole (1) on the stand to depress the release button, and then pull the head unit from the stand (2).

 **NOTE:** If a security screw is installed in the release hole, remove the screw with a T-10 screwdriver to access the release button.

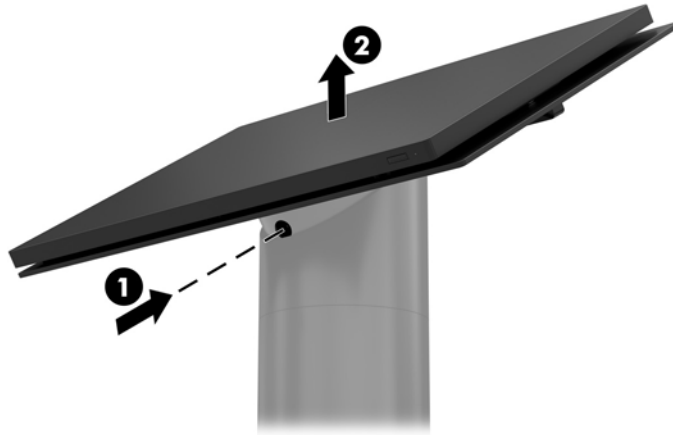

To attach the head unit to the stand, align the guide posts on the rear of the computer head unit with the corresponding holes in the stand's column, and then press the head unit onto the column.

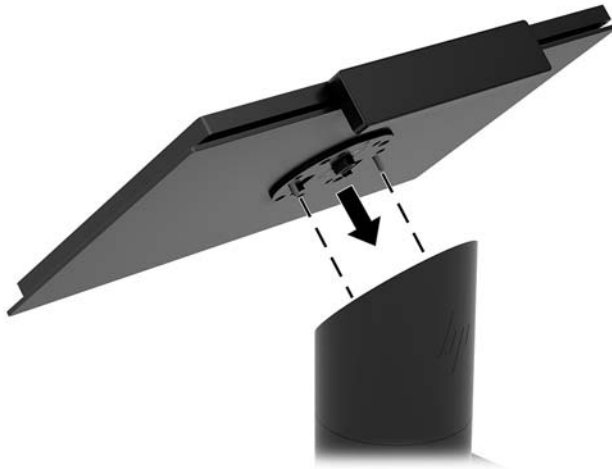

Mounting the Engage One head unit to a wall

You can use an optional VESA mounting bracket to mount the computer head unit to a wall.

Screws sizes are 241-I052-M004 for the security screw and 241-I042-M059 for the VESA mount screw.

1. Prepare the computer for disassembly ([Preparation for disassembly on page 19](#)).
2. Remove the computer head unit from the stand (if necessary) ([Removing and attaching the Engage One head unit to the stand on page 27](#)).
3. Attach the VESA mounting bracket to a wall.
4. Connect the USB Type-C power cable to the USB Type-C port on the VESA mounting bracket (1). Align the guide posts on the rear of the computer head unit with the corresponding holes in the VESA mounting bracket, and then press the head unit onto the VESA mounting bracket (2).

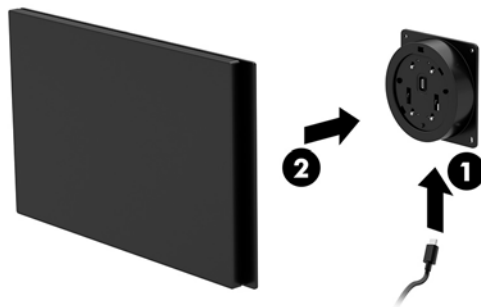

You also have the option of routing the USB Type-C cable out the rear of the VESA bracket and through a wall instead of attaching a USB Type-C cable to the port on the side of the bracket.

- a. Press the rear cover release tab (1) on the VESA bracket, and then pull the rear cover off the VESA bracket (2). Unplug the cable from the inside of the VESA bracket.

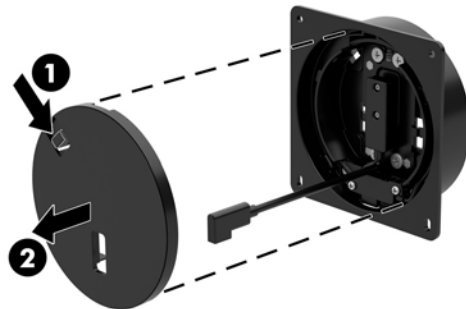

- b.** Route the USB Type-C cable from the inside of the VESA bracket through the slot on the bracket's rear cover (1), and then replace the rear cover (2).

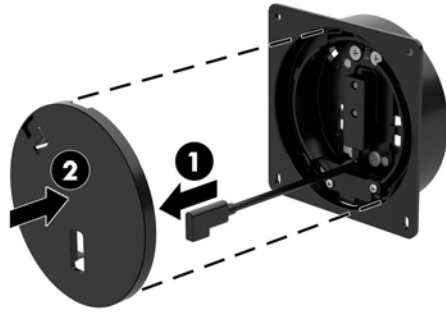

- 5.** Connect the power cable from the VESA bracket to a wall outlet or I/O connectivity base.

Mounting the Engage One to a counter top

You can use an optional counter top mounting bracket to mount the computer head unit and column to a counter top.

 **NOTE:** The mounting bracket requires an 80 mm hole in the counter top. The thickness of the counter top must be 10 mm to 50 mm.

1. If the stand's base is attached to the column, remove the screw on the underside of the column (1), and then remove the base from the column (2).

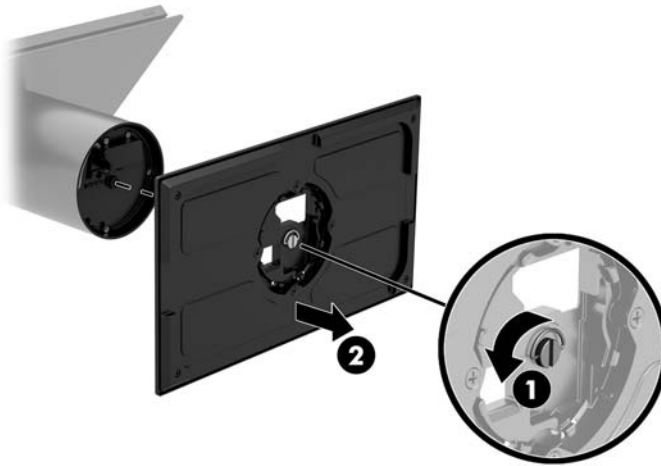

2. Route the cable(s) through the routing hole on the top piece of the mounting bracket (1) and attach the cable(s) to the bottom of the column (2).

 **NOTE:** If the column has a printer, there are four cables to connect. If it does not have a printer, there is one cable to connect.



3. Hold the top piece of the mounting bracket against the bottom of the column, route the cables through the hole in the mounting surface, and then place the column over the hole on the mounting surface.



4. The bottom piece of the mounting bracket can be oriented in two ways, depending on the thickness of your mounting surface. Orient the bracket properly for your application before attaching it.



5. Route the cables through the hole in the bottom piece of the mounting bracket (1). Press the mounting bracket against the bottom of the mounting surface (2), and then insert the screw (3) through the mounting bracket. Tighten the screw (4) so that the screw is fully inserted into the column, and then tighten the wing nut (5) on the screw to fasten the bracket to the mounting surface.

 **NOTE:** Screw size: 221-M006-001.

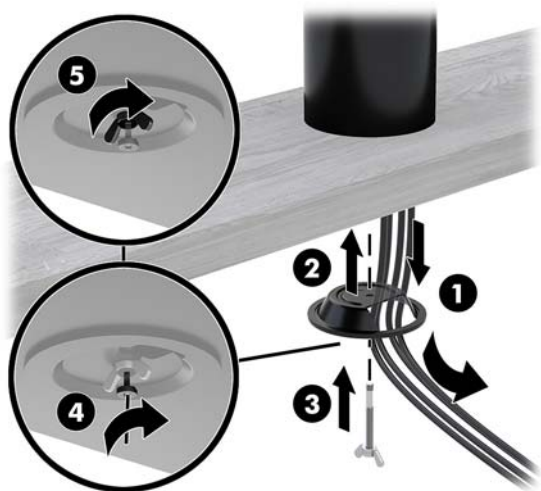

Installing a security cable on the I/O connectivity base

You can secure the I/O connectivity base to a fixed object with an optional Keyed Cable lock security cable extension and an optional security cable available from HP.

 **NOTE:** The security cable is sold separately as an aftermarket option kit only.

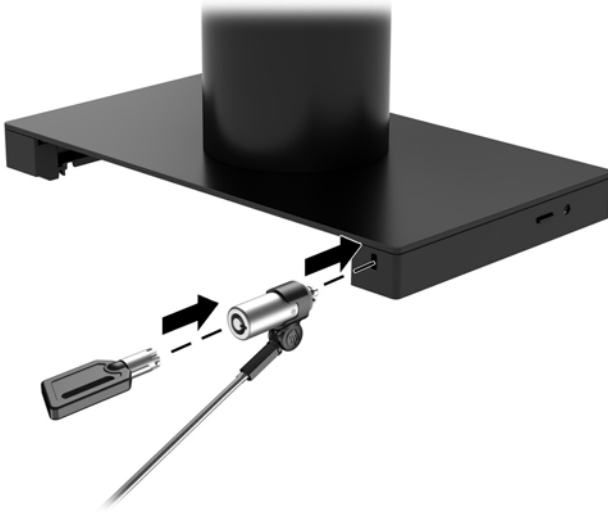

Installing a security cable on the Engage One column

You can secure the I/O connectivity base to a fixed object with an optional Keyed Cable lock security cable extension and an optional security cable available from HP.

 **NOTE:** The security cable is sold separately as an aftermarket option kit only.

1. Remove the screw from the bottom of the column (1).
2. Attach the security cable extension to the bottom of the column using the tamper-resistant screw (2) included with the security cable extension.
3. Secure the other end of the security cable extension with a security cable (3).

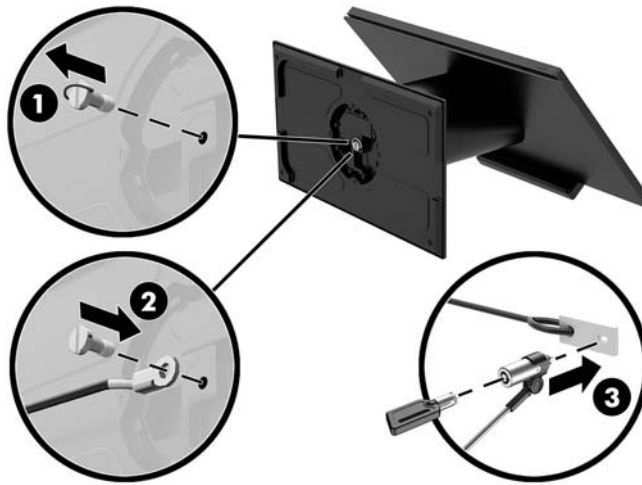

Installing a security screw on the Engage One head unit and stand

You can insert a tamper-resistant security screw into the computer's column with a T-10 screwdriver to prevent access to the computer head unit's release button.

1. Remove the security screw from the bottom of the stand's column.

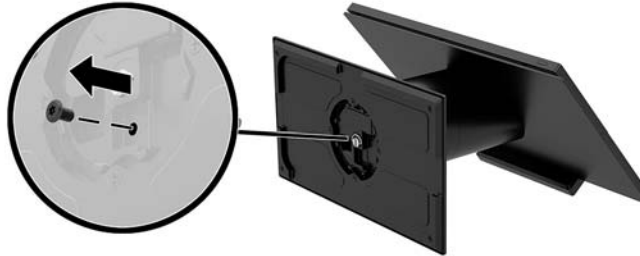

2. Install the security screw in the release button hole on the stand's column.

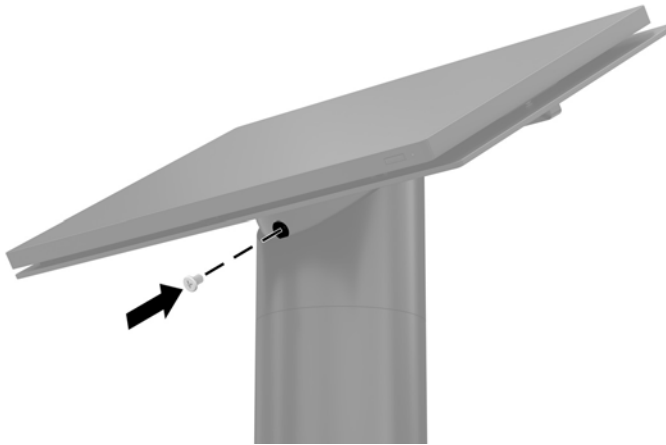

Installing a security screw on the Engage One head unit and VESA mount

You can insert a tamper-resistant security screw into the computer's VESA mount with a T-10 screwdriver to prevent access to the computer head unit's release button.

1. Press the rear cover release tab (1) on the VESA bracket, and then pull the rear cover off the VESA bracket (2). Then remove the security screw (3) from inside the VESA bracket, and then replace the rear cover (4).

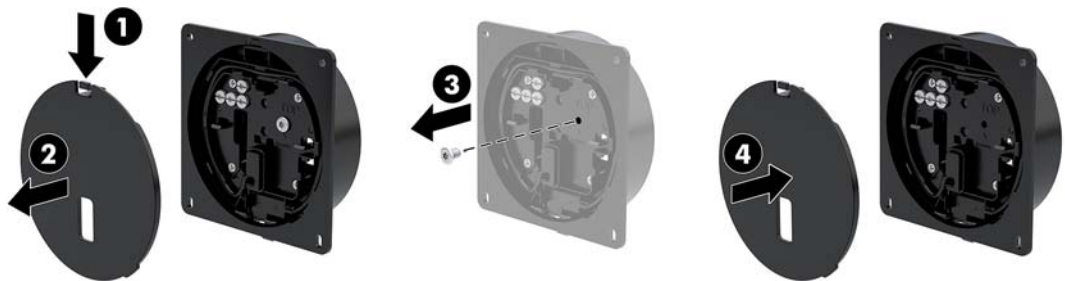

2. Press the head unit onto the VESA mount (1) if it is not already attached, and then install the security screw (2) in the release button hole on the VESA mount.

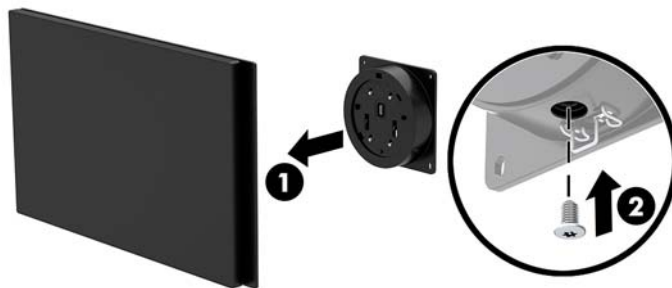

Removing and replacing the column printer

1. Prepare the computer for disassembly ([Preparation for disassembly on page 19](#)).
2. Remove the receipt paper from the printer.
3. Disconnect the printer and system power sources and any attached devices.
4. Place the computer with the display panel face down on a flat surface covered by a soft clean cloth, and then remove the I/O connectivity base ([Attaching an I/O connectivity base to the Engage One on page 20](#)).
5. Remove the USB-C power cable.
6. Loosen the captive screw that secures the stand base to the printer base plate (1).

7. Lift stand base **(2)** to access the cables connected to the printer.

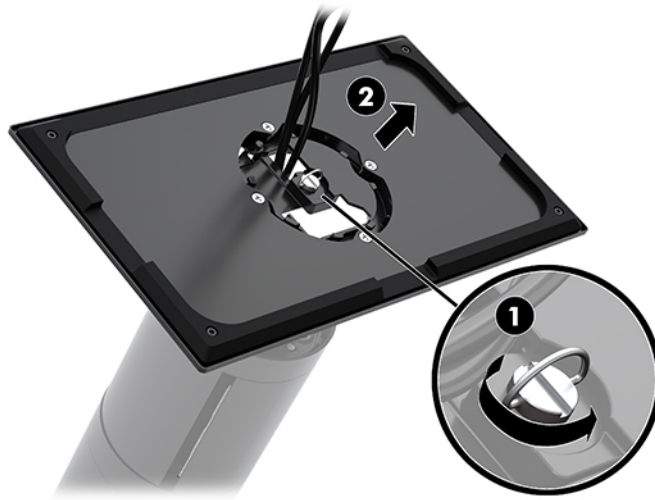

8. Remove the cables from the clips on the printer base plate **(1)**.
9. Disconnect the cables from the printer and remove the cables and stand base **(2)**.

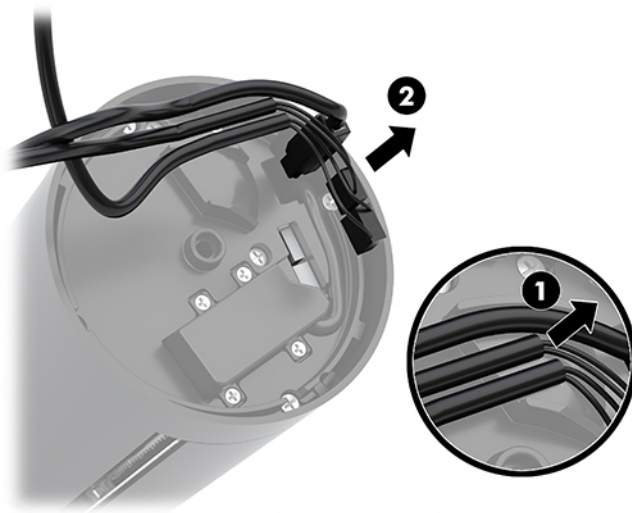

10. Rotate the column up to expose the head unit release hole **(1)**.

 **IMPORTANT:** If a security screw is installed in the release hole, remove it to access the release button .

- 11.** Insert a screwdriver into the release hole to depress the release button **(2)**, and then pull the column up and off of the head unit **(3)**.

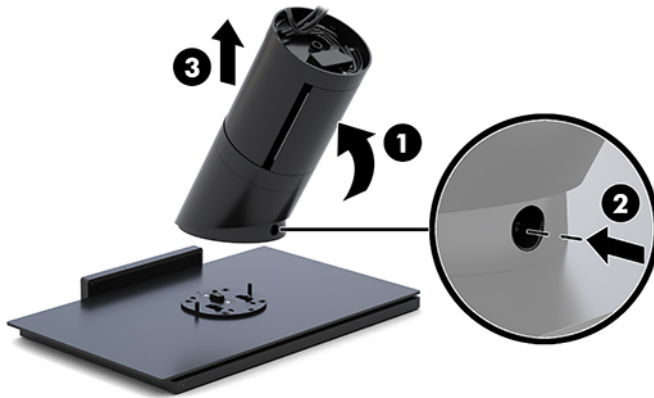

- 12.** Remove the column printer door cover:

- a. Open the printer door **(1)**.
- b. Remove the two Phillips head screws with the lock washers and bushings **(2)** from the top and bottom of the door cover.



- c. Use a small flat head screwdriver to pry the retaining tab from behind the door cover hook **(1)**.
- d. Press the door cover hook out of the slot in the door frame **(2)**.



NOTE: You may need to use a flat head screwdriver to help disengage the hook from the slot.

- e. Pull the door cover off of the door frame (3).

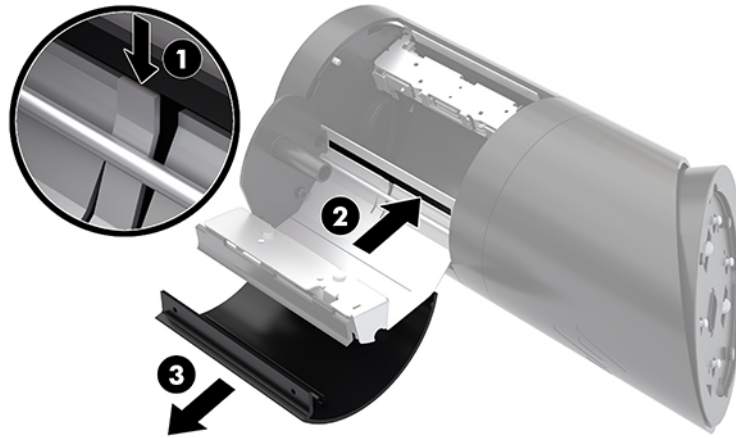

13. Close the printer door.

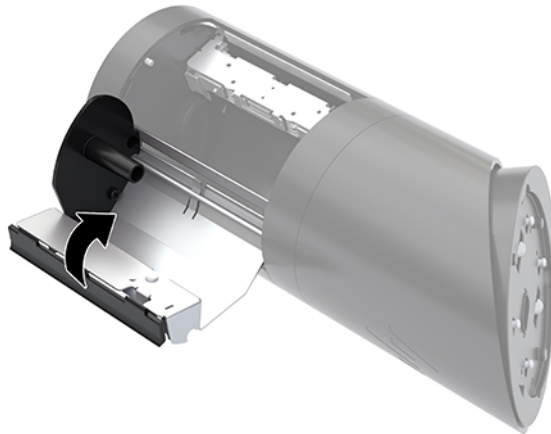

14. Remove the four Phillips screws that secure the stand cable connector housing, and then pull the cable cover away from the printer base.

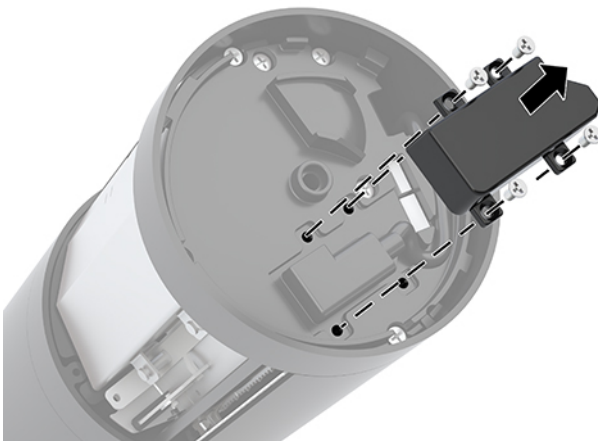

15. Remove the three Phillips head screws that secure the printer engine to the bottom of the column.

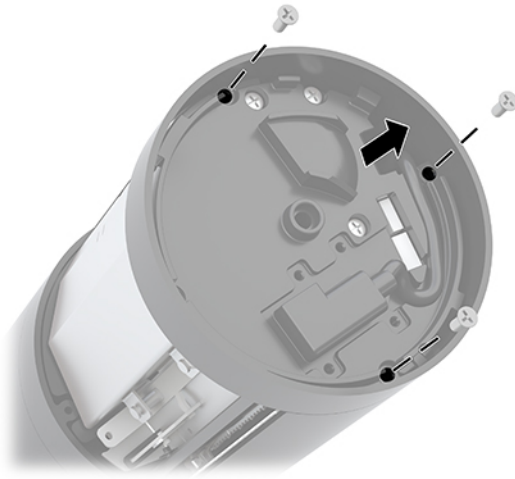

 **IMPORTANT:** Do not remove any screws marked with 'P' on the base plate.

16. Slide the printer engine about ¼ inch (0.6 cm) out of the column **(1)**.
17. Carefully remove the paper feed button from the opening in the column **(2)**.
18. Continue sliding the printer engine out of the column and remove **(3)**.

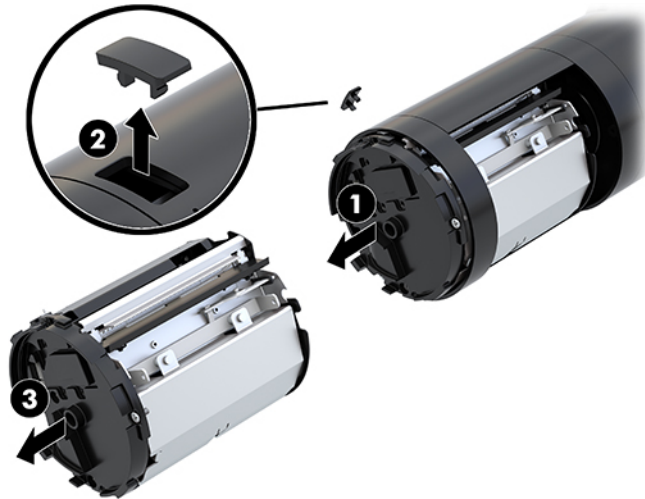

To replace the column printer, reverse the removal procedures. Please note the following tips when replacing the column printer.

- Remove the alignment pin from the bottom of printer engine.

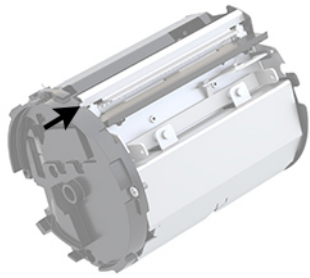

- Holding the column with the door side up, ensure that the stand cable is on the far side of the alignment rod **(1)**.

While holding the paper feed actuator arm down, slide the printer engine into the column until the actuator arm is visible through hole **(2)**.

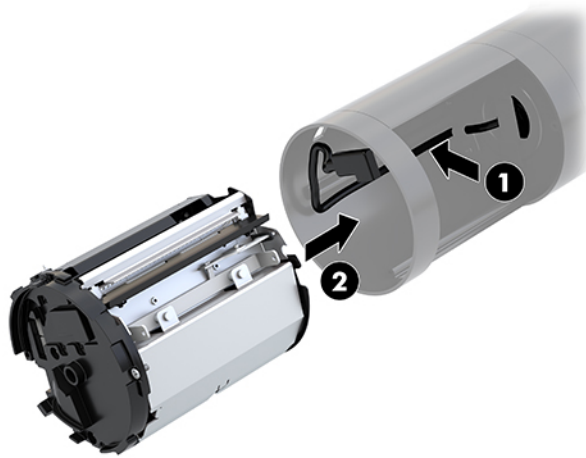

- With the alignment stud oriented toward the top of the column, place the paper feed button into the opening in the column **(1)**.

Continue sliding the printer engine into the column until the button is fully engaged and the engine is fully seated **(2)**.

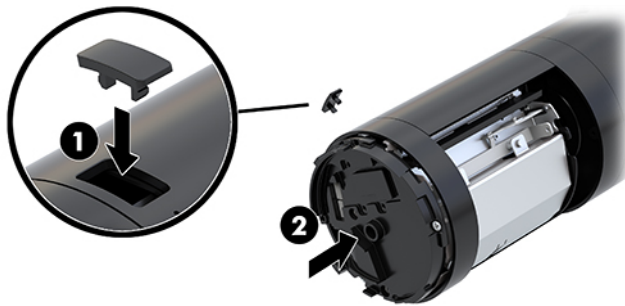

Removing the display panel

You must remove the display panel from the computer head unit to access internal computer components.

1. Prepare the computer for disassembly ([Preparation for disassembly on page 19](#)).
2. Remove the computer head unit from the stand ([Removing and attaching the Engage One head unit to the stand on page 27](#)).
3. Loosen the three captive screws in the slot on the bottom of the computer head unit.

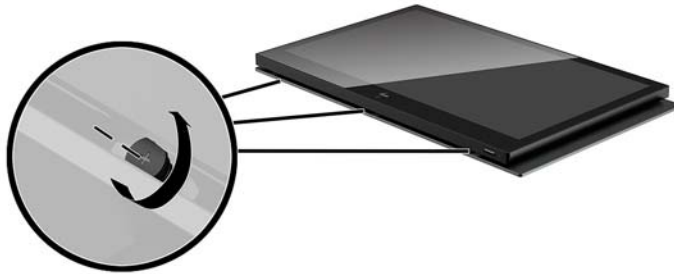

4. Separate the computer's display panel from the computer head unit at the connection points, and then lift the display panel up approximately 2.5 cm (one inch).

 **IMPORTANT:** Do not lift the display panel higher than 2.5 cm (one inch) from the computer head unit. An internal cable must be disconnected before the display panel can be fully removed.

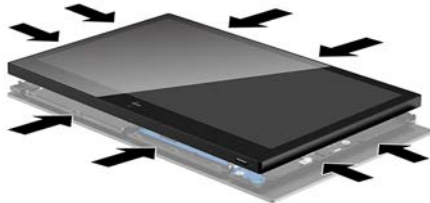

5. Holding the display panel 2.5 cm (one inch) from the computer head unit, shift the display panel forward no more than 7.5 cm (three inches) (1) to access the display cable connection. Lift the edges of the tape that covers the display cable connection (2), and then disconnect the display cable from the connector on the system board (3) by pulling the tab on the cable end.

 **IMPORTANT:** Be careful not to fold the edges of the tape. It must be replaced when the display cable is reconnected.

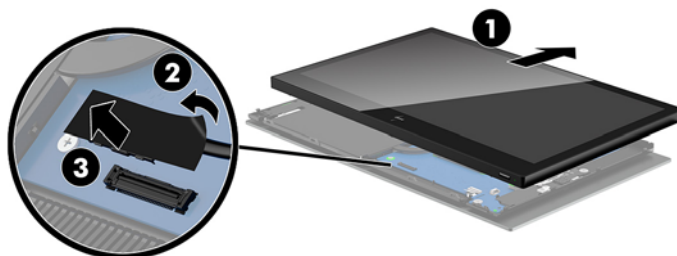

6. Rotate the display panel over the top of the computer head unit and onto a flat surface covered by a soft clean cloth.

 **IMPORTANT:** The touch and WLAN cables will still be connected between the top of the display panel and the top of the computer head unit. Be careful when removing the display panel so that the cables do not become disconnected.

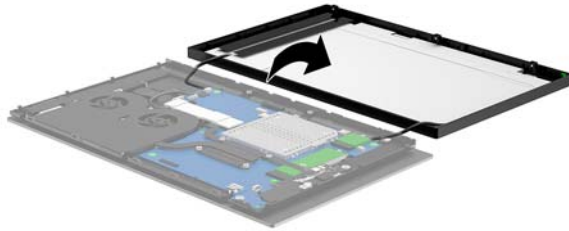

7. Disconnect the touch cable from the system board and the WLAN antennas from the WLAN module.
To replace the display panel, reverse the removal procedures.

System board components

Refer to the table below to locate the system board components referenced in this guide.

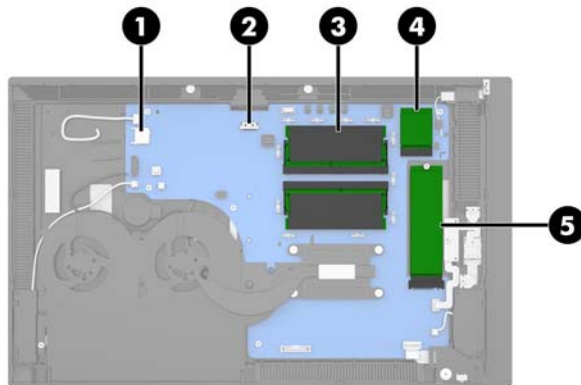

System board components

(1) SD card slot	(4) WLAN module
(2) CFID connector	(5) M.2 SSD
(3) Memory modules	

Installing a 2 x 20 customer-facing display (CFD)

1. Prepare the computer for disassembly ([Preparation for disassembly on page 19](#)).
2. Remove the computer head unit from the stand ([Removing and attaching the Engage One head unit to the stand on page 27](#)).
3. Remove the display panel from the computer head unit ([Removing the display panel on page 41](#))
4. Remove the rubber stoppers from the CFD cable routing channel and the two CFD screw holes.

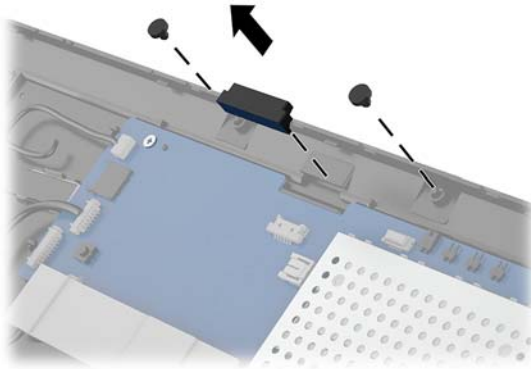

5. Route the CFD cable through the routing channel on the computer head unit (1). Pull the cable all the way through the channel (2), and then slide the screw tabs on the CFD into the slots on the computer head unit (3).

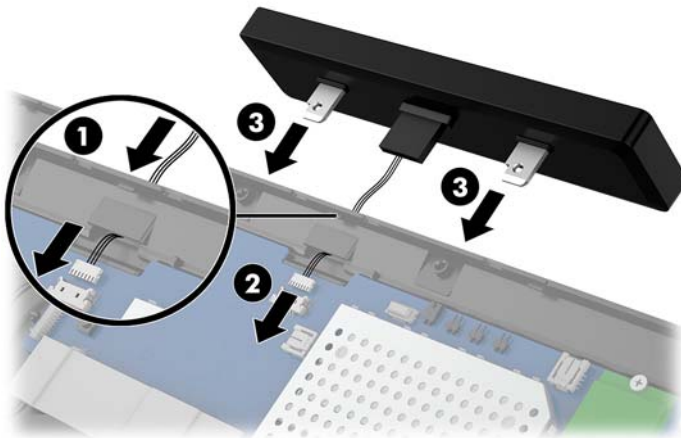

6. Install the two screws that attach the CFD to the computer head unit (1), and then connect the CFD cable to the connector on the system board (2).

 **IMPORTANT:** Make sure the entire CFD cable is pulled all the way through the head unit routing channel before installing the CFD so that the cable does not get pinched between the CFD and the head unit.

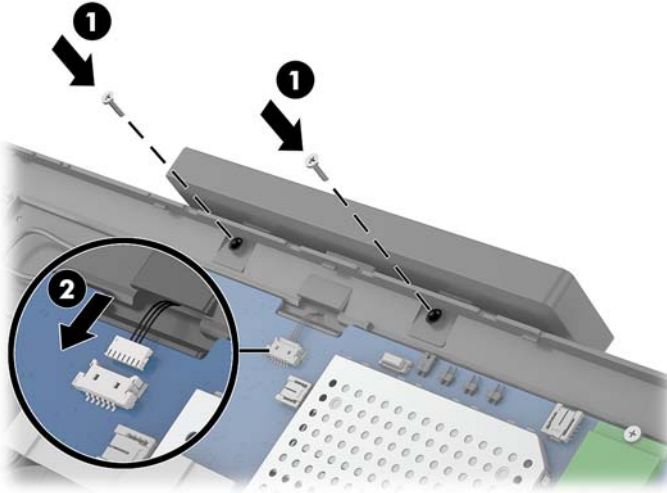

7. Replace the computer head unit's display panel.
8. Attach the computer head unit to the stand. See [Removing and attaching the Engage One head unit to the stand on page 27](#).
9. Reconnect the power cord and press the power button.

Memory modules

The computer comes with at least one preinstalled double data rate 4 synchronous dynamic random access memory (DDR4-SDRAM) small outline dual in-line memory module (SODIMM). There are two memory sockets on the system board that can be populated with up to 32 GB of memory.

DDR4-SDRAM SODIMMs

For proper system operation, the memory modules must be 1.2 volt DDR4-SDRAM SODIMMs and adhere to the following specifications:

- Industry-standard 260-pin
- Unbuffered non-ECC PC4-19200 DDR4-2400 MHz-compliant
- Support CAS latency DDR4 2400 MHz (17-17-17 timing)
- Contain the mandatory Joint Electronic Device Engineering Council (JEDEC) specification

The computer supports the following:

- 512-Mbit, 1-Gbit, 2-Gbit, 4-Gbit, and 8-Gbit non-ECC memory technologies
- Single-sided and double-sided SODIMMs
- The following SODIMMs are offered:
 - 4 GB (1 x 4 GB) DDR 42400 SODIMM memory
 - 8 GB (1 x 8 GB) DDR 42400 SODIMM memory
 - 8 GB (2 x 4 GB) DDR 42400 SODIMM memory
 - 16 GB (1 x 16 GB) DDR 42400 SODIMM memory
 - 16 GB (2 x 8 GB) DDR 42400 SODIMM memory
 - 32 GB (2 x 16 GB) DDR 42400 SODIMM memory

 **NOTE:** The system will not operate properly if you install unsupported SODIMMs.

Removing a SODIMM

 **CAUTION:** You must disconnect the power cord and wait approximately 30 seconds for the power to drain before replacing the memory module. Regardless of the power-on state, voltage is always supplied to the memory module as long as the computer is plugged into an active AC outlet. Adding or removing the memory module while voltage is present may cause irreparable damage to the memory module or system board.

The memory module socket has gold-plated metal contacts. When upgrading the memory, it is important to use a memory module with gold-plated metal contacts to prevent corrosion and/or oxidation resulting from having incompatible metals in contact with each other.

Static electricity can damage the electronic components of the computer or optional cards. Before beginning these procedures, ensure that you are discharged of static electricity by briefly touching a grounded metal object. For more information, refer to [Electrostatic discharge information on page 16](#).

When handling a memory module, be careful not to touch any of the contacts. Doing so may damage the module.

To remove and install a memory module:

1. Prepare the computer for disassembly ([Preparation for disassembly on page 19](#)).
2. Remove the computer head unit from the stand ([Removing and attaching the Engage One head unit to the stand on page 27](#)).
3. Remove the display panel from the computer head unit ([Removing the display panel on page 41](#))
4. Remove the shield over the memory modules by pulling the tab on the shield up (1), and then lifting the shield from the system board (2).

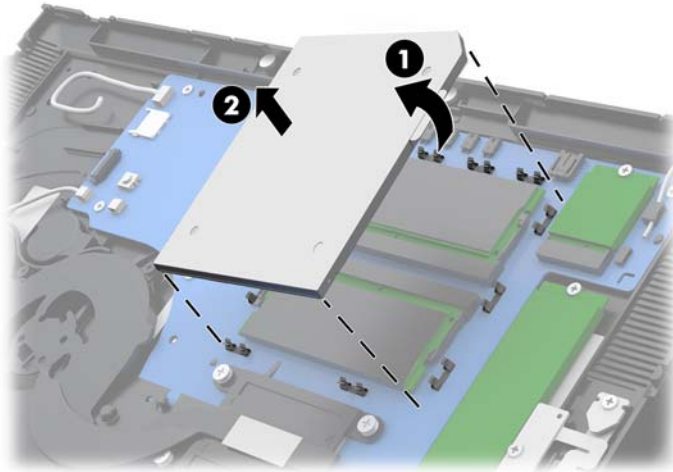

5. To remove a memory module, press outward on the two latches on each side of the memory module (1), and then pull the memory module out of the socket (2).

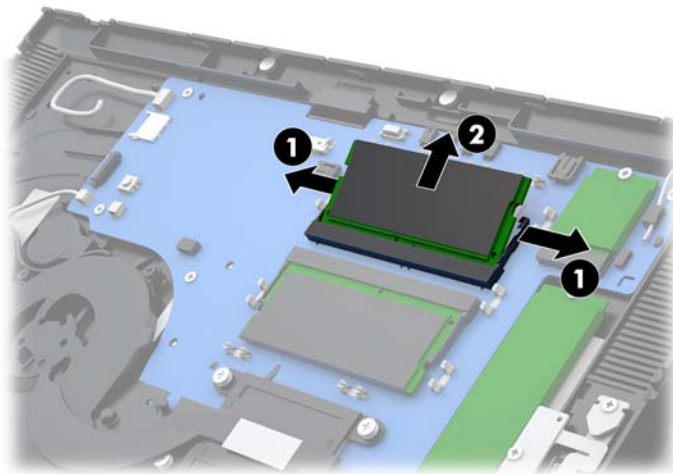

6. To install a memory module, slide the new memory module into the socket at approximately a 30° angle (1), and then press the memory module down into the socket (2) so that the latches lock it in place.

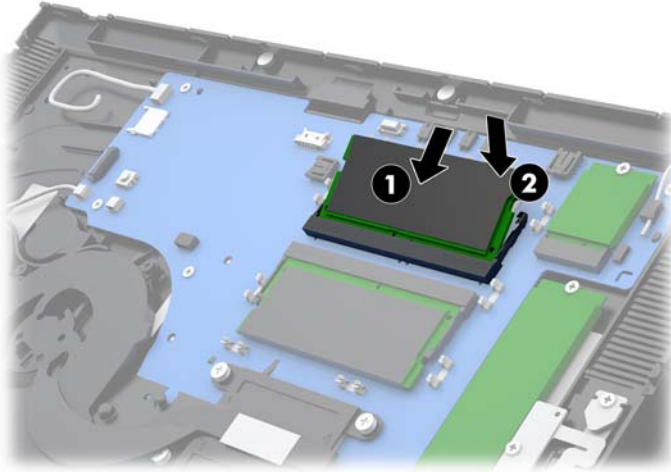

 **NOTE:** A memory module can be installed in only one way. Match the notch on the module with the tab on the memory socket.

7. Replace the shield over the memory modules by pressing the left side of the shield down onto the system board (1) and then the pressing the right side down (2).

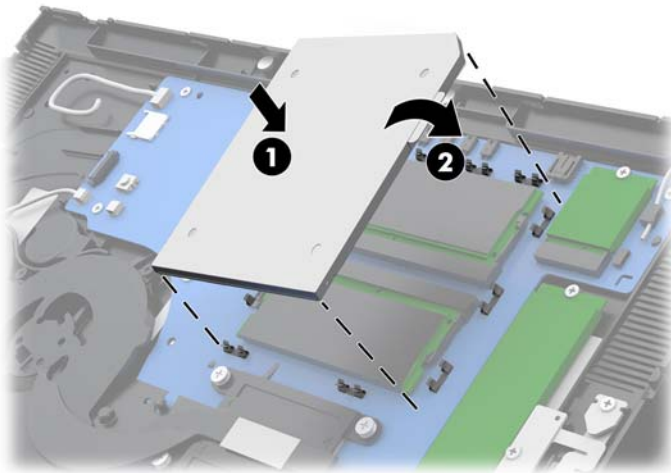

The computer automatically recognizes the additional memory when you turn on the computer.

Removing and installing an M.2 solid-state drive (SSD)

 **IMPORTANT:** If you are replacing an SSD, be sure to back up the data from the old SSD so that you can transfer the data to the new SSD.

To remove and install an M.2 storage device:

1. Prepare the computer for disassembly ([Preparation for disassembly on page 19](#)).
2. Remove the computer head unit from the stand ([Removing and attaching the Engage One head unit to the stand on page 27](#)).
3. Remove the display panel from the computer head unit ([Removing the display panel on page 41](#)).
4. To remove an SSD, remove the screw that secures the SSD to the system board (1), and then slide the SSD out of the system board connector (2).

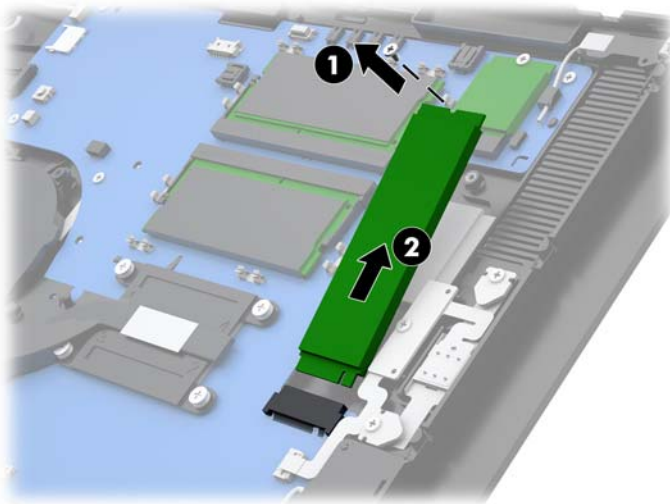

5. To install an SSD, slide the connector end of the SSD into the system board connector (1), and then secure the other end of the SSD to the system board with the screw (2).

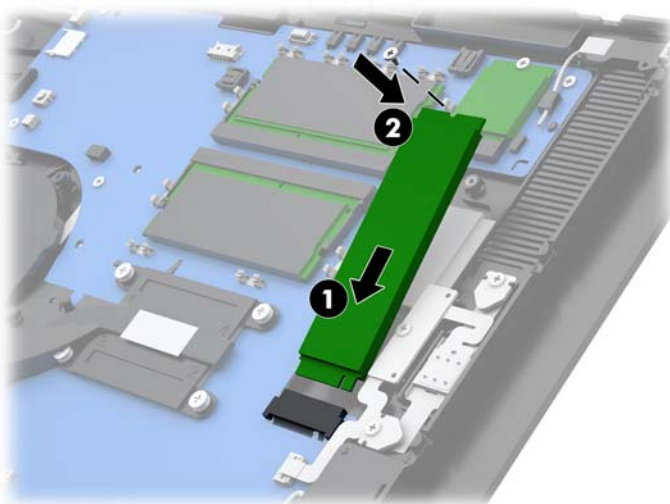

Removing the WLAN module

Description

802.11 a/b/g/n + Bluetooth 4.0, 2x2

802.11 a/b/g/n + Bluetooth 4.0, 2x2 (for use only in Indonesia)

Intel Dual Band Wireless-AC 8260

The WLAN module is secured with one screw and has two connected antennas.

To remove the WLAN module:

1. Prepare the computer for disassembly ([Preparation for disassembly on page 19](#))
2. Remove the computer head unit from the stand ([Removing and attaching the Engage One head unit to the stand on page 27](#)).
3. Remove the display panel from the computer head unit ([Removing the display panel on page 41](#))
4. To remove a WLAN module, disconnect the WLAN cables (1), remove the screw (2) that secures the module to the system board, and then slide the module out of the system board connector (3).

 **IMPORTANT:** The WLAN cables and connectors are labeled **1** and **2**. Make sure that you match the numbered labels on the WLAN module with the numbered labels on the cables when reconnecting the cables.

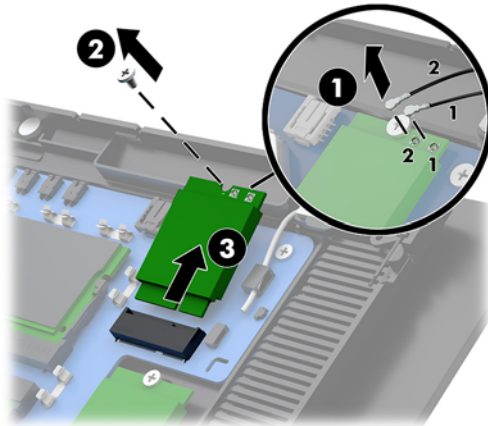

5. To install a WLAN module, slide the connector end of the module into the system board connector (1), then secure the other end of the module to the system board with the screw (2), and then connect the two cables from the display panel to the connectors on the WLAN module (3).

 **IMPORTANT:** The WLAN cables and connectors are labeled **1** and **2**. Make sure that you match the numbered labels on the WLAN module with the numbered labels on the cables when connecting the cables.

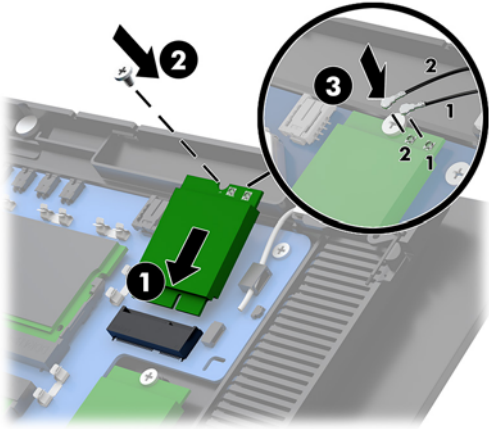

To install a WLAN module, reverse the removal procedures.

Removing the heat sink

The heat sink is secured to the system board, under the heat sink shield.

To remove the heat sink:

1. Prepare the computer for disassembly ([Preparation for disassembly on page 19](#)).
2. Remove the computer head unit from the stand ([Removing and attaching the Engage One head unit to the stand on page 27](#)).
3. Remove the display panel from the computer head unit ([Removing the display panel on page 41](#)).
4. In the order indicated on the heat sink, loosen the five captive Phillips screws that secure the heat sink to the system board **(1) - (5)**.
5. Lift the heat sink off the system board **(6)**.

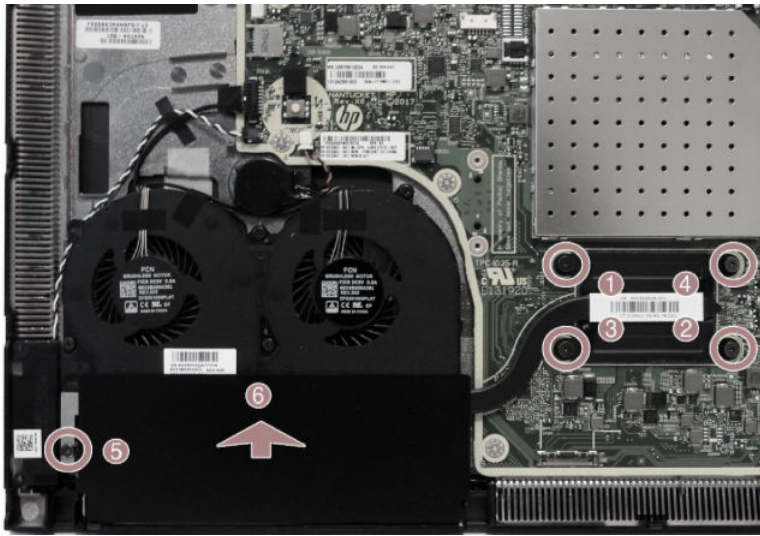

⚠ CAUTION: To reduce a degradation in thermal performance, be sure not to touch the thermal grease on the surface of the processor or the heat sink.

To replace the heat sink, reverse the removal procedures.

Removing the fan assembly

The fan assembly is secured with four screws and has one cable.

To remove the fan:

1. Prepare the computer for disassembly ([Preparation for disassembly on page 19](#)).
2. Remove the computer head unit from the stand ([Removing and attaching the Engage One head unit to the stand on page 27](#)).
3. Remove the display panel from the computer head unit ([Removing the display panel on page 41](#))
4. Disconnect the fan cable from the system board (**1**), and then remove the tape that secures the cable to the system board (**2**).
5. Loosen the four captive Phillips screws (**3**) that secure the fan assembly to the computer head unit.
6. Remove the fan assembly from the computer head unit (**4**).

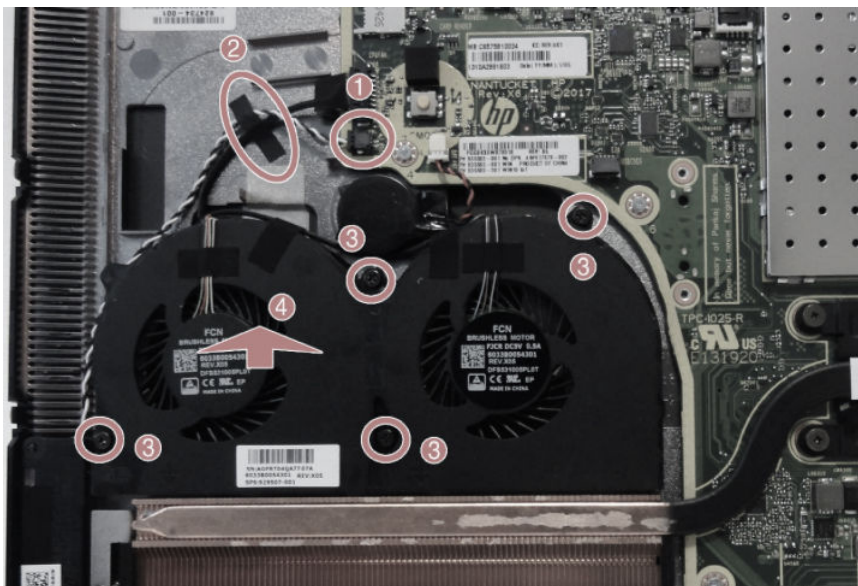

To reinstall the fan assembly, reverse the removal procedure.

Removing the speakers

The computer uses two separate speakers located on the left and right sides. Each speaker has a cable that connects to a separate connector.

To remove the speakers:

1. Prepare the computer for disassembly ([Preparation for disassembly on page 19](#)).
2. Remove the computer head unit from the stand ([Removing and attaching the Engage One head unit to the stand on page 27](#)).
3. Remove the display panel from the computer head unit ([Removing the display panel on page 41](#))
4. For each speaker, disconnect the cable from the system board (1), and then use a flat tool to pry each speaker out of the computer head unit (2). The speakers are held in place with adhesive.

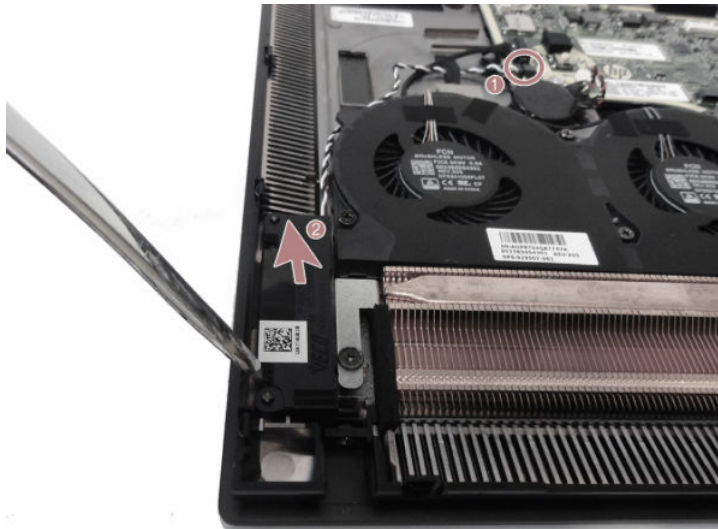

To replace the speakers, reverse the removal procedures.

Removing the power button board

The power button board is secured with one Phillips screws.

To remove the power button board:

1. Prepare the computer for disassembly ([Preparation for disassembly on page 19](#)).
2. Remove the computer head unit from the stand ([Removing and attaching the Engage One head unit to the stand on page 27](#)).
3. Remove the display panel from the computer head unit ([Removing the display panel on page 41](#))
4. Disconnect the cable from the system board ZIF connector **(1)**, and then lift the cable up to disengage it from the adhesive that secures the cable to the system board.
5. Remove the Phillips screw **(2)**.
6. Lift the power button board out of the computer head unit **(3)**.

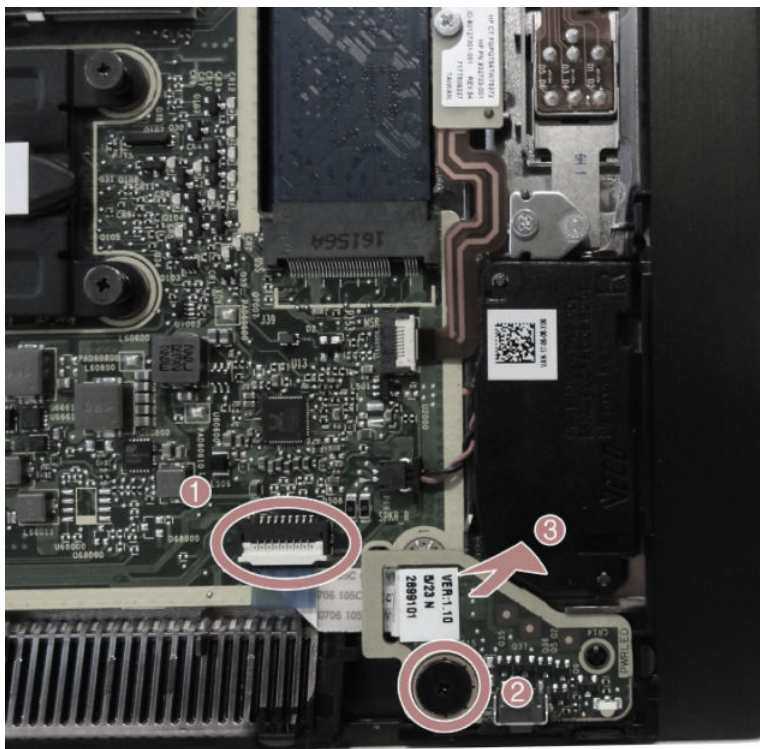

To reinstall the power button board, reverse the removal procedure.

Removing the MSR (Magnetic Stripe Reader)

The MSR consists of two main components that are connected together into one assembly.

To remove the MSR assembly:

1. Prepare the computer for disassembly ([Preparation for disassembly on page 19](#)).
2. Remove the computer head unit from the stand ([Removing and attaching the Engage One head unit to the stand on page 27](#)).
3. Remove the display panel from the computer head unit ([Removing the display panel on page 41](#))
4. Remove the top screw **(1)** and bracket **(2)**, and then remove the bottom Phillips screw **(3)** and bracket **(4)** from the reader.



5. Disconnect the MSR board cable from the system board **(1)**.

 **TIP:** Take extra care when disconnecting the cable. Pulling on the cable prematurely, before it is disconnected, could cause damage to the connector.

6. Remove the Phillips screw **(2)** from the MSR board.

7. Lift the board straight up and off the posts (3).

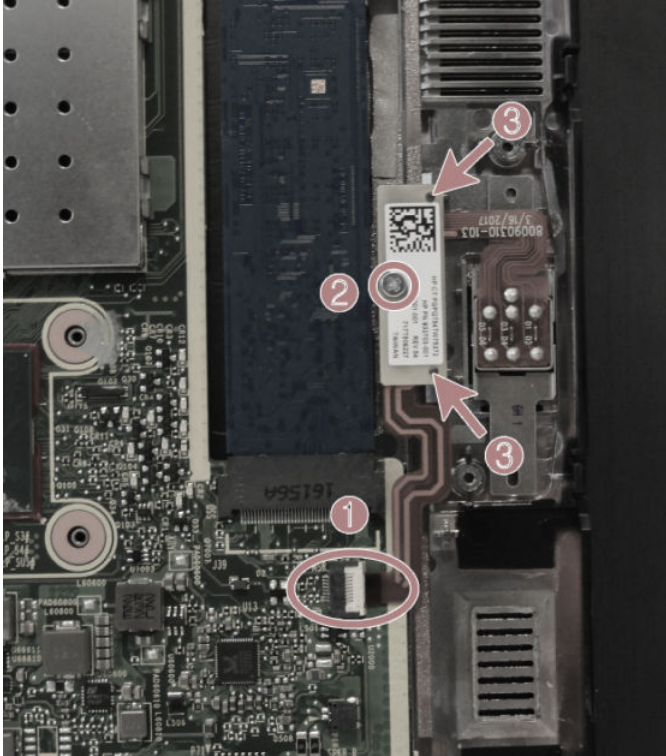

8. Remove the MSR (assembly from the computer head unit).

MSR configuration

LED swipe code: green = good; red = bad

Single beep = good read; three beeps = good read on all three tracks

For information about MSR encryption, see [Solving retail system-specific problems on page 103](#).

Verifying a successful installation of the MSR

To verify a successful installation of the MSR:

1. Check Device Manager and verify that the computer has found the MSR hardware and loaded its drivers successfully.
2. Test the MSR to ensure it is reading magnetic data as follows:
 - a. Make sure the device is in USB-HID-KBD mode (default for the MSR).
 - b. Open Microsoft Notepad and swipe a credit card.
 - c. Verify that data appears in Notepad (the data will be unreadable). If nothing appears in Notepad, confirm that the MSR is in USB-HID-KB mode.

Testing the MSR in USG HID mode

To test the MSR in USB HID mode, the MSR OPOS driver must be installed. To verify the installation:

1. Launch the MSR OPOS Test utility from Windows start menu.
2. Open, Claim, and Enable [O/C/E] (DeviceEnabled) the device in OPOS or JPOS.

3. Swipe a credit card.
4. Disable, Release, and Close [D/R/C] the test application.

 **TIP:** USB HID mode requires an application that uses OPOS or JPOS drivers to confirm that the MSR is able to read the data.

Non-encrypted or encrypted:

HID MODE + NATIVE DRIVER

Human Interface Devices\USB Input Device

USB\VID_03F0&PID_0457

HID-KEYBOARD MODE + NATIVE DRIVER (DEFAULT)

Human Interface Devices\USB Input Device

USB\VID_03F0&PID_0557

Keyboards\HID Keyboard Device

HID\VID_03F0&PID_0557

To reinstall the MSR assembly, reverse the removal procedure.

Enabling encryption on the MSR

RKI (Remote Key Injection) over the Internet is the only way to encrypt the MSR other than sending the entire system to a Key Injection Facility (KIF).

 **NOTE:** Injecting the key using RKI can only be performed by the company named 'ID Tech.'

ID Tech provides the necessary forms, procedures, tools, information, and timelines.

1. Contact ID Tech, which will provide a Windows-based computer remote key loading software application. The software can run independently or be integrated within the business application.
2. The Remote Key Loading software communicates with ID Tech devices through serial (RS232) and USB interfaces.

You can also use Remote Key Loading software to retrieve a serial number and to find out if readers support remote key injection.

3. Make sure that the computer has internet connectivity. The Remote Key Loading software will automatically connect to an ID Tech remote key loading server and send/receive an encrypted package between the remote key loading server and ID Tech devices.

Removing the MSR LED board

The MSR LED board is a separate component from the MSR. It is secured with one Phillips screw.

To remove the MSR LED board:

1. Prepare the computer for disassembly ([Preparation for disassembly on page 19](#)).
2. Remove the computer head unit from the stand ([Removing and attaching the Engage One head unit to the stand on page 27](#)).
3. Remove the display panel from the computer head unit ([Removing the display panel on page 41](#))
4. Disconnect the cable from the system board **(1)**.

 **TIP:** Take extra care when disconnecting the cable. Pulling on the cable prematurely, before it is disconnected, could cause damage to the connector.

5. Remove the Phillips screw **(2)** that secures the board to the computer head unit.
6. Remove the board and cable assembly from the computer head unit **(3)**.

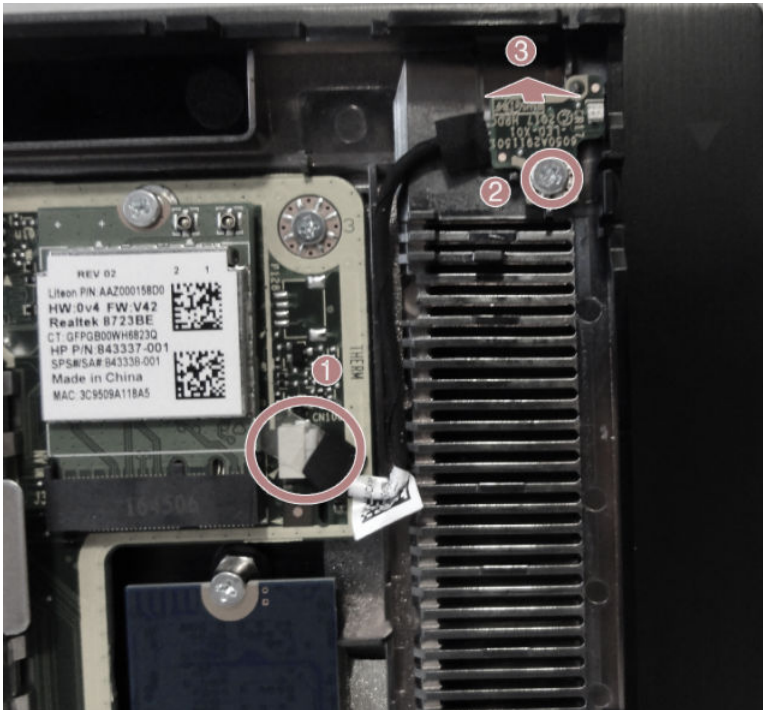

To install the MSR LED board, reverse the removal procedures.

Removing the system board

 **NOTE:** All system board spare part kits include replacement thermal material. System boards include an integrated Intel processor.

The system board is secured with six screws. Additionally, the system board is secured by the display connector from the rear of the display.

To remove the system board:

1. Prepare the computer for disassembly ([Preparation for disassembly on page 19](#)).
2. Remove the computer head unit from the stand ([Removing and attaching the Engage One head unit to the stand on page 27](#)).
3. Remove the display panel from the computer head unit ([Removing the display panel on page 41](#)).
4. Remove the heat sink ([Removing the heat sink on page 51](#)).
5. Remove the power button board ([Removing the power button board on page 54](#)).
6. When replacing the system board, make sure the following components are removed from the defective system board and installed on the replacement system board:
 - Memory modules ([Memory modules on page 45](#))
 - M.2 storage device ([Removing and installing an M.2 solid-state drive \(SSD\) on page 48](#))
 - WLAN module ([Removing the WLAN module on page 49](#))
7. Position the computer head unit upside down.
8. Remove the two Phillips screws and lift off the connector.

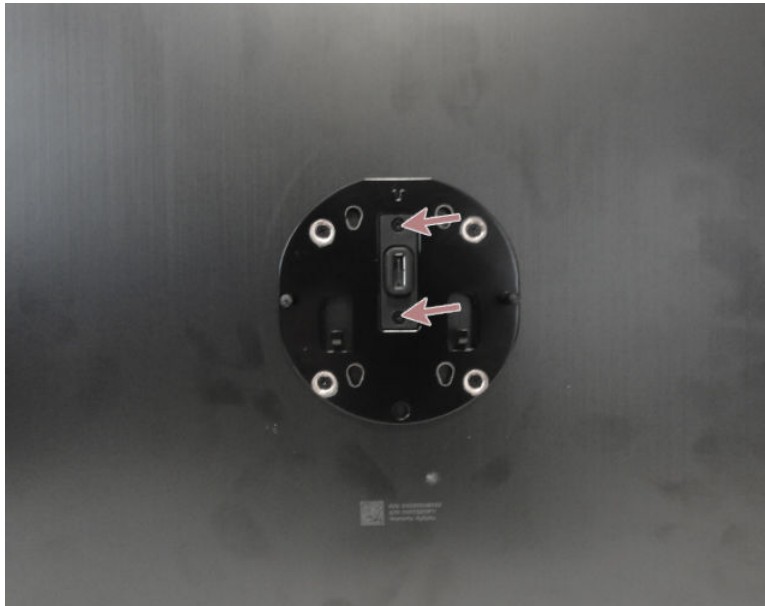

9. Disconnect the following cables from the system board:

- (1) MSR LED board
- (2) Fingerprint reader board
- (3) Right speaker
- (4) Power button board
- (5) RTC battery
- (6) Left speaker
- (7) Fan assembly

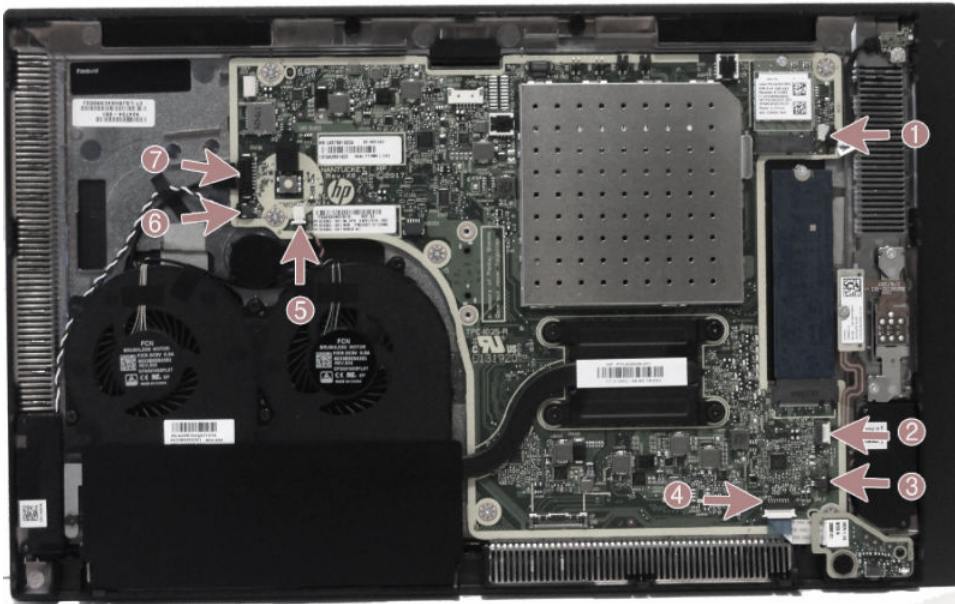

10. Remove the 6 Phillips screws that secure the system board to the computer head unit (1).

11. Remove the system board from the computer head unit (2).

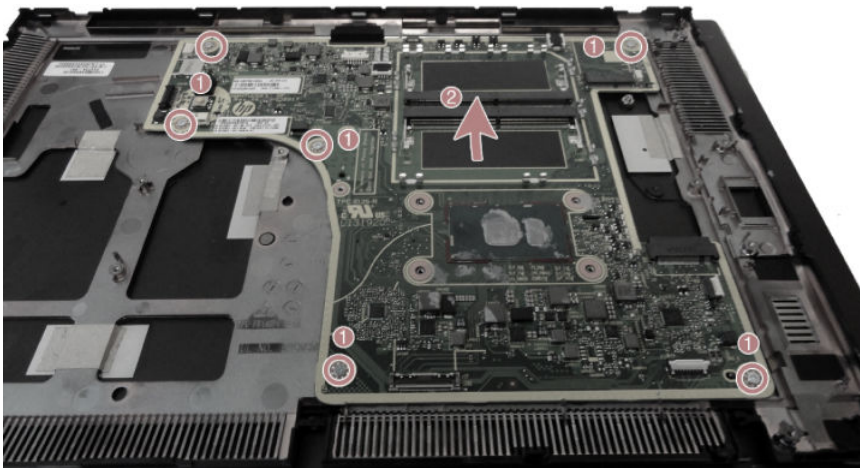

To install the system board, reverse the removal procedures.

 **NOTE:** When replacing the system board, you must change the chassis serial number in the BIOS.

System board callouts

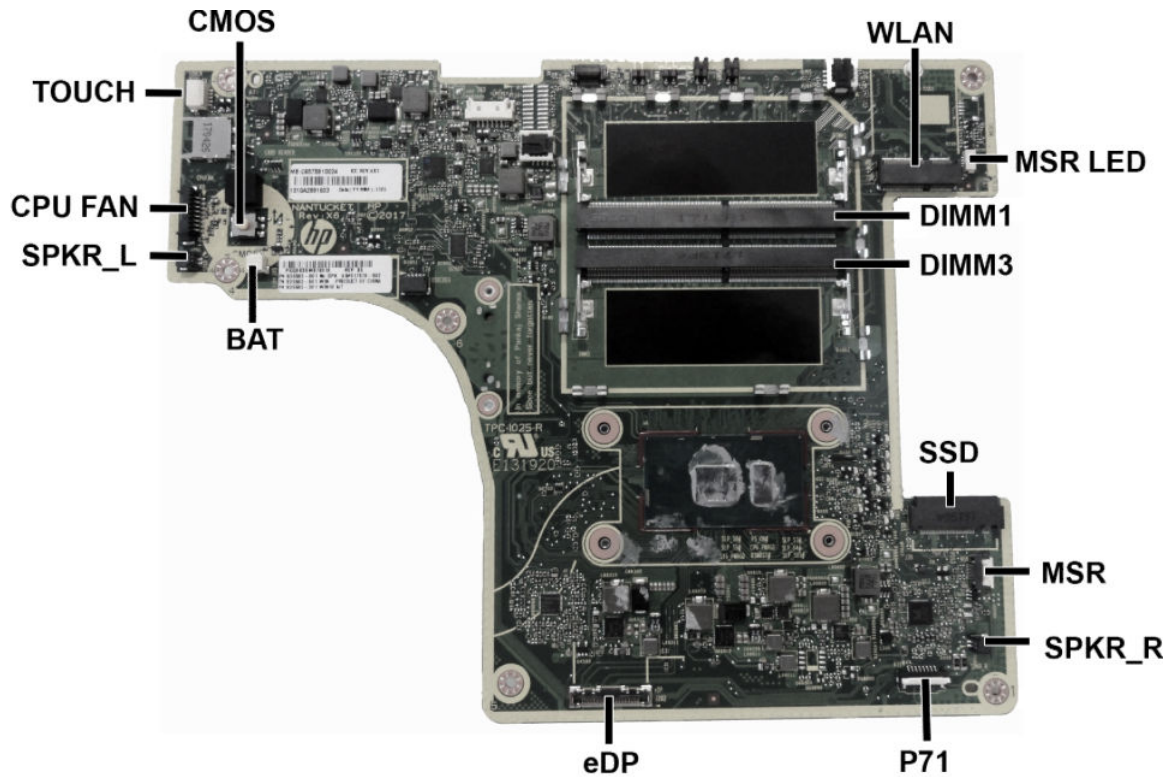

Sys Bd Label	Color	Component	Sys Bd Label	Color	Component
BAT	White	RTC battery	MSR LED	White	MSR LED board
CMOS	Yellow	Reset CMOS	P71	Black	Power button board
CPU FAN	Black	Fan assembly	SSD	Black	Solid-state drive
DIMM1	Black	Memory module	SPKR_L	Black	Speaker
DIMM3	Black	Memory module	SPKR_R	Black	Speaker
eDP	Silver	Display connector	TOUCH	White	Touch board
MSR	Black	MSR board	WLAN	Black	WLAN module

Removing the antennas

The wireless antenna cables connect from the WLAN module to antennas at the top of the computer.

To remove the antennas:

1. Prepare the computer for disassembly ([Preparation for disassembly on page 19](#)).
2. Remove the computer head unit from the stand ([Removing and attaching the Engage One head unit to the stand on page 27](#)).
3. Remove the display panel from the computer head unit ([Removing the display panel on page 41](#))
4. Position the display panel upside down.
5. Peel the foam off the top of the display panel.

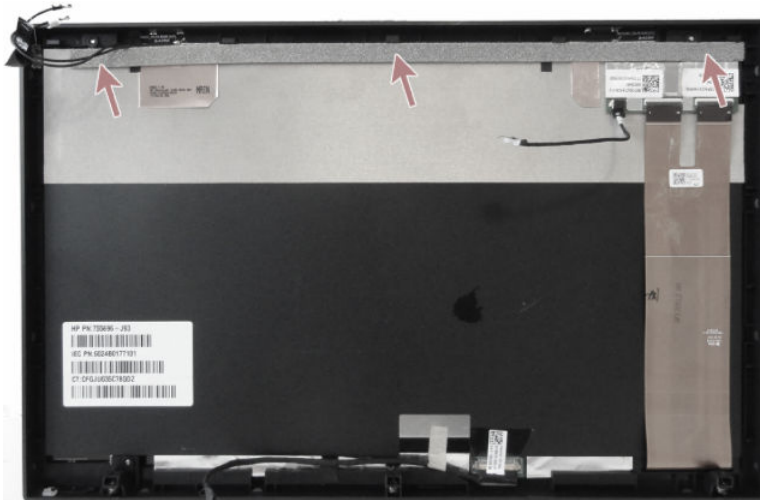

6. Peel the antennas off the top of the display panel (1), and then remove the cables from the routing paths along the top of the display (2).

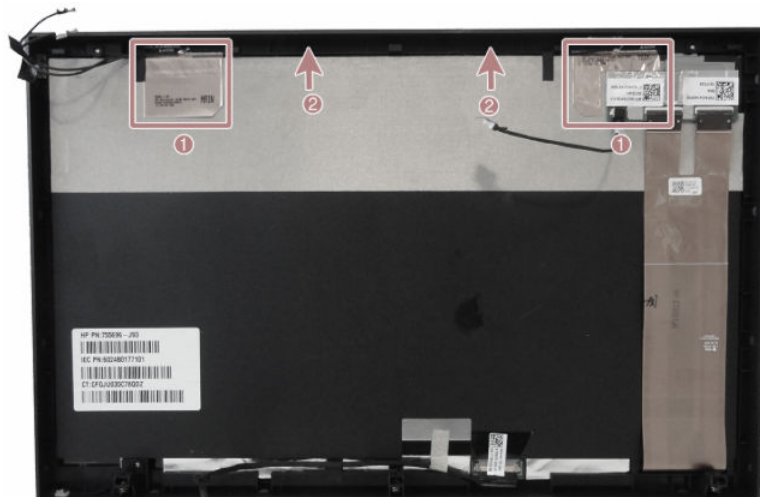

To reinstall the antennas, reverse the removal procedure.

5 Using the column printer

The column printer is an optional component that may be included with your system.

Standard features

Standard features	
Interface	USB
Memory/firmware	8 MB flash memory, History EEROM, 4k buffer
Energy-savings	Option to configure printer to enter low-power (1 watt) idle state if no data is received after user-specified number of minutes
Resident character sets	PC code pages 437 (US), 720 (Arabic), 737 (Greek), 775 (Baltic), 850 (Multilingual), 852 (Latin II), 857 (Turkish), 858 (with Eurosymbol), 860 (Portuguese), 862 (Hebrew), 863 (French Canadian), 864 (Arabic), 865 (Nordic), 866 (Cyrillic), 874 (Thai), 1250 (Windows Central Europe), 1251 (Windows Cyrillic), 1252 (Windows Latin I), 1254 (Windows Turkish), 1255 (Windows Hebrew), 1256 (Windows Arabic), 1257 (Windows Baltic), 28591 (Windows Latin 1), 28592 (Windows Latin 2), 28594 (Windows Baltic), 28596 (Windows Arabic), 28599 (Windows Turkish), 28605 (Windows Latin 9), Katakana, and KZ_1048 (Kazakh)
Downloadable fonts	Code pages 932 (Kanji), 949 (Korean), 936 (Simplified Chinese), and 950 (Traditional Chinese)
Integrated bar codes	Code 39, Code 93, Code 128, UPC-A, UPC-E, JAN8 (EAN), JAN13 (EAN), Interleaved 2 of 5, Codabar, Code 128, PDF-417 (two-dimensional), Code 128 extended, GS1 Databar, QR code, and Datamatrix
Print	Monochrome in either 44 (standard) or 56 (compressed) columns on 80 mm wide thermal paper
Paper path	80.0 mm
Roll Diameter	50.8 mm max. (2 inches)
Print resolution	8-dots/mm
Speed	Up to 114 mm/second throughput (monochrome)
Paper sensing	Paper out
Human interface	Audible tone from speaker (software-driven). Simple commands in configuration menu issued through paper feed button. Green LED status light, located next to the paper feed button.
Cash drawer driver	Connector for one or two cash drawers (obtain a "Y" cord for two drawers)
Knife	Paper cutter standard on all units

Printing features

The printer is versatile, with diverse printing options available. Text, graphics, and bar codes can be presented in many different forms and sizes. For more information on programming the printer to change text, graphics, or other characteristics, refer to the *Programming Guide*.

When to change the receipt paper

Change the paper when it is near the end of the roll or when the roll is empty. When the paper is low, you must monitor usage to avoid running out part of the way through a transaction. When the roll is empty, you must load a new roll immediately or data may be lost.

- When the paper is low, a colored stripe appears on the receipt paper (if the paper purchased has a stripe) indicating that enough paper remains for a small transaction.
- When the roll is empty, a green LED on the printer flashes quickly indicating the paper must be installed.

 **IMPORTANT:** Do not try to operate the printer or host computer if the printer runs out of paper. The printer may continue to accept data from the host computer even though it is unable to print. Data may be lost as a result.

Loading the printer receipt paper

1. Open the receipt cover by pushing up evenly on each side of the cover until it unsnaps (1).
2. Remove the test printout or used paper roll if necessary.
3. Place the receipt paper into the paper compartment on the spindle so that it unrolls from the inside (2). Leave a few inches of paper sticking out of the printer. To prevent jamming, make sure the paper is between the guidelines.
4. While holding the paper in place, close the receipt cover (3) making sure to apply a little more pressure after the first click to ensure that it is fully latched. When fully latched with paper installed, the LED will stop blinking.

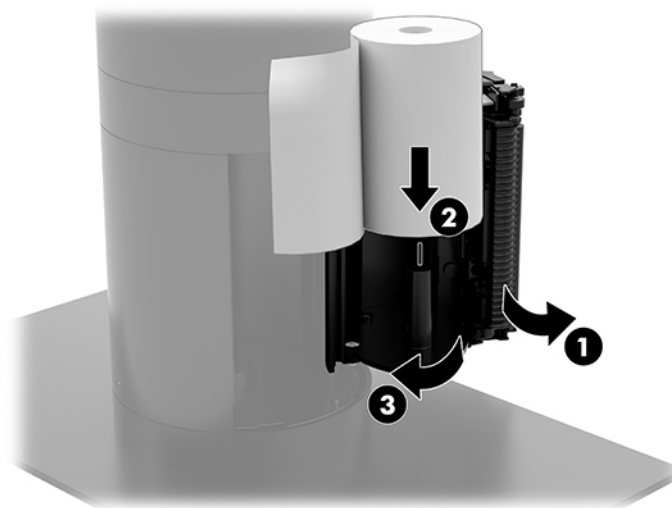

- To test that the paper is loaded correctly, advance the paper with the paper feed button (1), and then tear the excess paper off against the knife on the cover. A steady green LED (2) means the printer is on and operating normally. If the LED is flashing, the cover may not be completely shut.

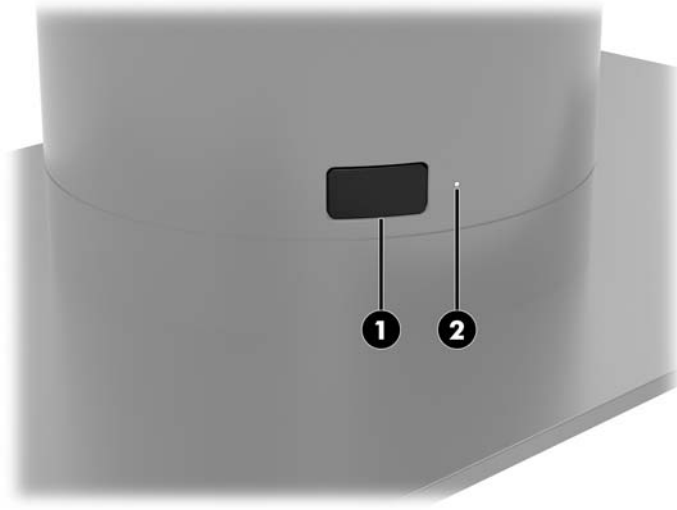

Thermal paper specifications

The printer requires qualified thermal paper with the following dimensions:

- Width:** 80 +0/-0.6 mm (3.15 +0/-0.03")
- Diameter:** 50.8 mm max. (2")

The paper must not be attached at the roll's core. Use paper with a colored stripe at the end to indicate that the paper is running low.

The above figures are based on a core diameter of 22 ± 0.5 mm (0.87") outside and 11.5 ± 0.5 mm (0.45") inside.

Qualified paper grades

Contact the manufacturer of your choice to order paper. HP recommends the following paper grades produced by their respective manufacturers. There are a number of paper manufacturers qualified to provide this paper, provided the POS paper rolls are from the recommended grades for monochrome (black ink) paper.

Qualified manufacturers	Phone/Fax	Paper grade
Appvion, Inc. (USA) 825 E. Wisconsin Ave. Appleton, WI 54912 http://www.appvion.com	Voice: (800) 922-1729 Fax: (800) 922-1712	Alpha 400-2.3 (was T1030) Alpha 800-2.4 (was T1012A) POS-Plus 600-2.4 Alpha 900-3.4 (was Superior) All current Appvion papers are BPA-free
Jujo Thermal Ltd. P.O. Box 92 FI-27501 Kaukua, Finland	Voice: 358 (0) 10 303 200 Fax: 358 (0) 10 303 2419	AF50KS-E3 AP62KS-E3

Qualified manufacturers	Phone/Fax	Paper grade
http://www.jujothermal.com/		
Kanzaki Specialty Papers (USA) 20 Cummings St. Ware, MA 01082-2002 http://www.kanzakiusa.com/	Voice: (888) 526-9254 Fax: (413) 731-8864	P30023 (was P-300), P31023 (was P-310), P35024 (was P-350), P35032 (was P-354), P39023 (BPA free, was P-390), P30521 (BPA free), P30523 (BPA free), P31523 (BPA free), P35532 (BPA free)
Koehler UK Ltd. (Great Britain) 2 White Oak Square London Road Swanley, Kent BR8 7AG, U.K. http://www.koehlerpaper.com/en/	Voice: (44) 1322 661010 Fax: (44) 1322 614656	KT55-F20
Koehler AG Hauptstr. 2-4 D-77704 Oberkirch, Germany http://www.koehlerpaper.com/en/	Voice: (49) 7802 81-0 Fax: (49) 7802 81-4330	KT55-F20
Mitsubishi Int'l Corp. (USA) 655 Third Ave. New York, New York 10017 http://www.mitsubishicorp.com/us/en/	Voice: (212) 605-2000 Fax: (212) 605-2597	P-5035 T-8051 TP-8065 PP-5051
OJI Paper Company Ltd. Ginza 4-chome Tokyo 104, Japan http://www.ojipaper.co.jp/english/	Voice: (81)3-3563-1111 Fax: (81)3-3563-1135	KF-60 PD-170R PD-170R
Thermal Solutions Intl, Inc. 6740 Broadview Ave, Suite D Jacksonville, FL 32254 http://thermalsolutionsinternational.com	Voice: (800) 479-6070, (904) 860-1966 Fax: (904) 646-4530	19018RDT Features: 30% post-consumer waste, recycled/BPA free

Troubleshooting the printer

The printer is generally trouble-free; however, unexpected conditions may arise. Refer to the following sections to diagnose and solve these printer conditions. To resolve complex issues, you may need to contact an authorized HP service representative.

Printer tone and green LED

Condition	Possible causes	Possible solutions	Where to go for more information
Green LED, quick steady flashing.	Paper roll is empty.	Load a new paper roll.	See Loading the printer receipt paper on page 64 .
	Receipt cover is open.	Close the cover. If the problem persists, continue opening and closing the cover until the LED stops blinking.	
Green LED, slow steady flashing.	The knife is unable to return to the home position.	Stop using the printer.	Contact your authorized HP service representative.
	Other problems may be indicated.	Stop using the printer.	Contact your authorized HP service representative.
Printer beeps (two-tone—low frequency, high frequency).	Printer has been turned on and is ready to operate.	No action is required.	
Printer beeps and flashes green LED in various combinations.	These all indicate a serious condition.	Stop using the printer.	Contact your authorized HP service representative.

Printing issues

Condition	Possible causes	Possible solutions	Where to go for more information
Colored stripe on the receipt.	Paper is low.	Change the paper.	See Loading the printer receipt paper on page 64 .
Receipt does not come out all the way.	Paper is jammed.	Open the receipt cover, inspect the knife, and clear any jammed paper.	
Printer starts to print, but stops while the receipt is being printed.	Paper is jammed.	Open the receipt cover, inspect the knife, and clear any jammed paper.	
Receipt is not cut.	Paper is jammed.	Open the receipt cover, inspect the knife, and clear any jammed paper.	
Print is light or spotty.	Paper roll is loaded incorrectly.	Reload the paper correctly.	See Loading the printer receipt paper on page 64 .
	Thermal printhead is dirty.	Use recommended thermal receipt paper and clean the printhead with 99% isopropyl alcohol.	
Vertical column of print is missing.	Variations in paper.	Increase print density in Set Hardware Options of printer configuration menu to 110% or 120% as needed.	Contact your authorized HP service representative.
	This indicates a serious condition with the printer	Stop using the printer.	

Condition	Possible causes	Possible solutions	Where to go for more information
	electronics or missing dot on printhead.		
One side of receipt is missing.	This indicates a serious condition with the printer electronics.	Stop using the printer.	Contact your authorized HP service representative.



NOTE: Using nonrecommended paper may damage the printhead and void the warranty.

Printer does not function

Condition	Possible causes	Possible solutions	Where to go for more information
Printer does not function when turned on and LED is off.	Power is not plugged in.	Check that the host or power supply is getting power.	
Printer does not function when turned on and LED is blinking.	Receipt cover is not fully closed.	Close and latch the receipt cover.	
Printer stops functioning.	Printhead has overheated.	Allow the printhead to cool down.	
	Printer is in energy-saving mode.	Press the paper feed button to revive the printer.	
Printer does not open.	Receipt cover is stuck.	Release the latch failsafe.	See Latch failsafe on page 69 .

Latch failsafe

In the event that the receipt cover becomes stuck, the printer has a failsafe to release the cover's latches. Using a thin pointed object, press the rectangular button adjacent to the printhead. With enough pressure, the latches should release, and the receipt cover should open.

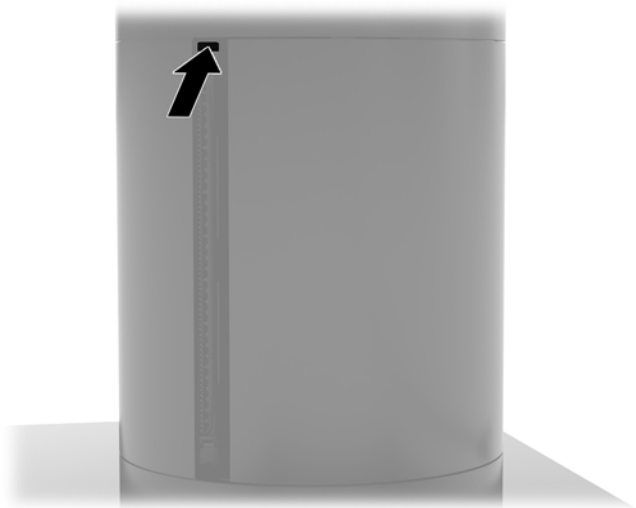

Cleaning the printer

Because of the way the printer sits while in use, it is likely there will be buildup of paper and other debris from the knife. HP recommends that you keep the printer in working order by periodically cleaning the debris from the printer.

To clean the printer, open the cover, remove the paper roll, and then use a can of compressed air to blow the debris out from the bottom plate where it accumulates.

6 Cable routing configurations

Cable matrix for Engage One with integrated column printer and basic I/O connectivity base

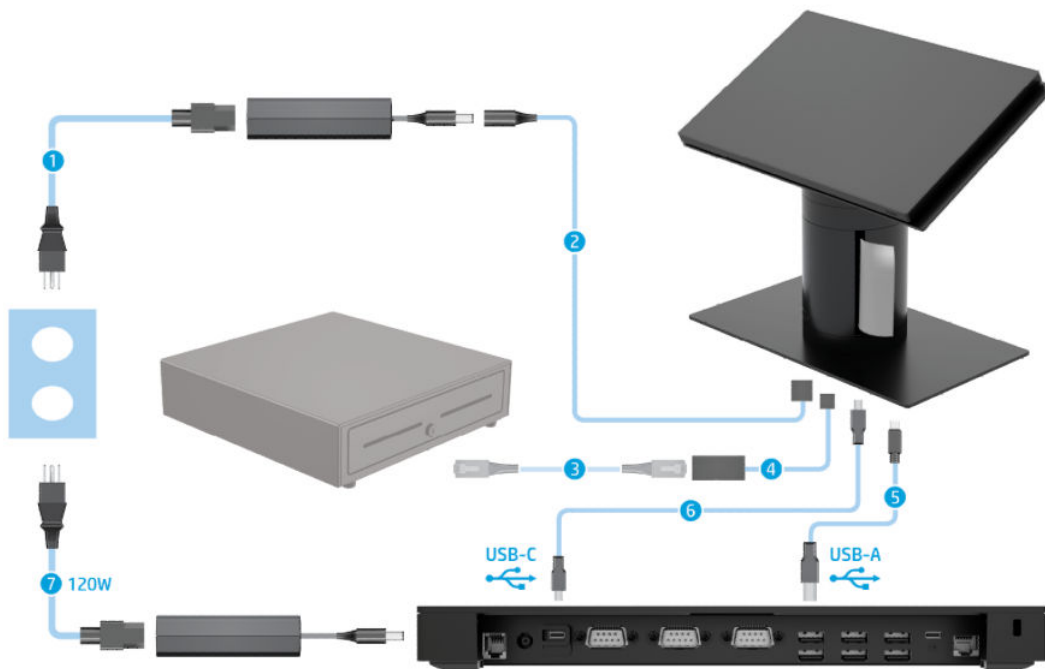

Cables

(1)	Column printer AC power cord	(5)	I/O connectivity base mini USB Type-B to USB Type-A data cable
(2)	Column printer AC adapter cable	(6)	I/O connectivity base USB Type-C cable
(3)	Cash drawer cable (purchased separately with cash drawer)	(7)	I/O connectivity base 120 W AC power cord
(4)	Column printer cash drawer cable		

Cable matrix for Engage One with integrated column printer and advanced I/O connectivity base

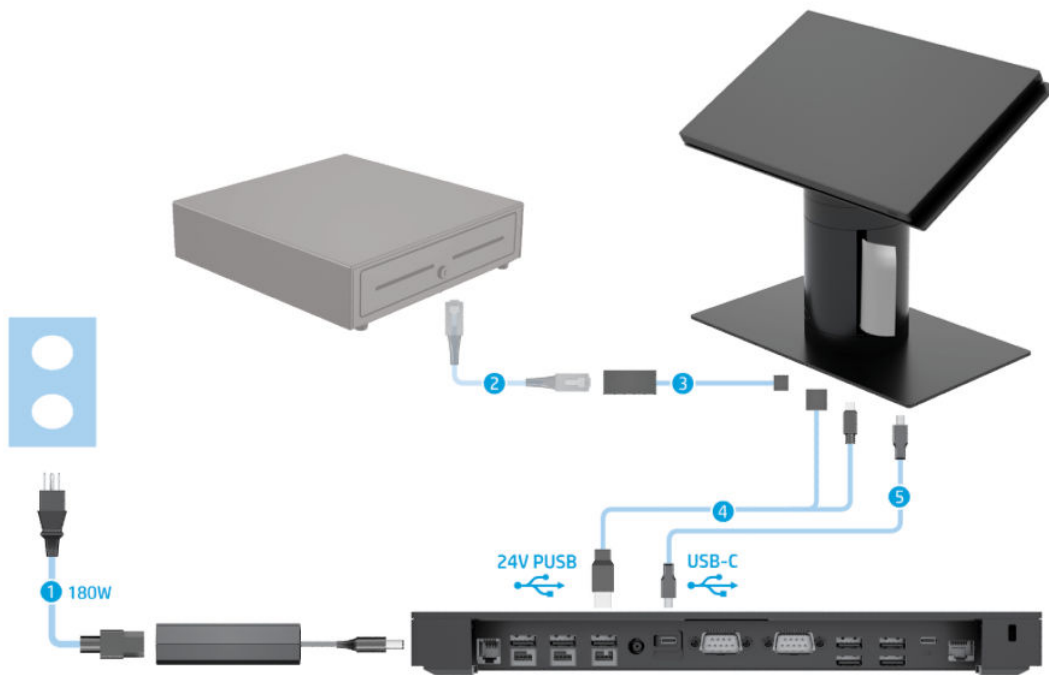

Cables

(1)	I/O connectivity base 180 W AC power cord	(4)	Column printer 24 V PUSB power and data Y cable
(2)	Cash drawer cable (purchased separately with cash drawer)	(5)	I/O connectivity base USB Type-C cable
(3)	Column printer cash drawer cable		

Cable matrix for Engage One without I/O connectivity base

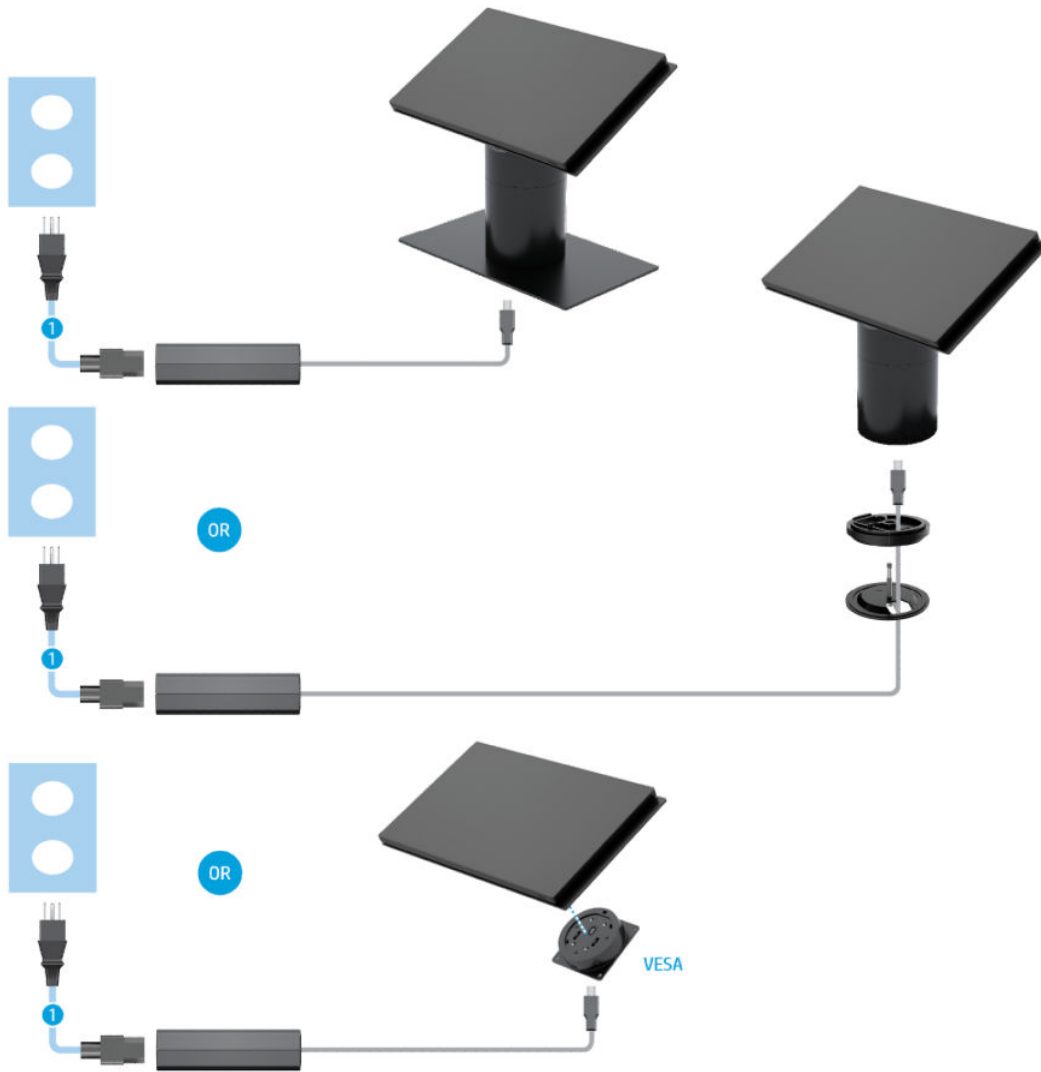

Cables

- (1) PC power cord
-

Cable matrix for Engage One with I/O connectivity base

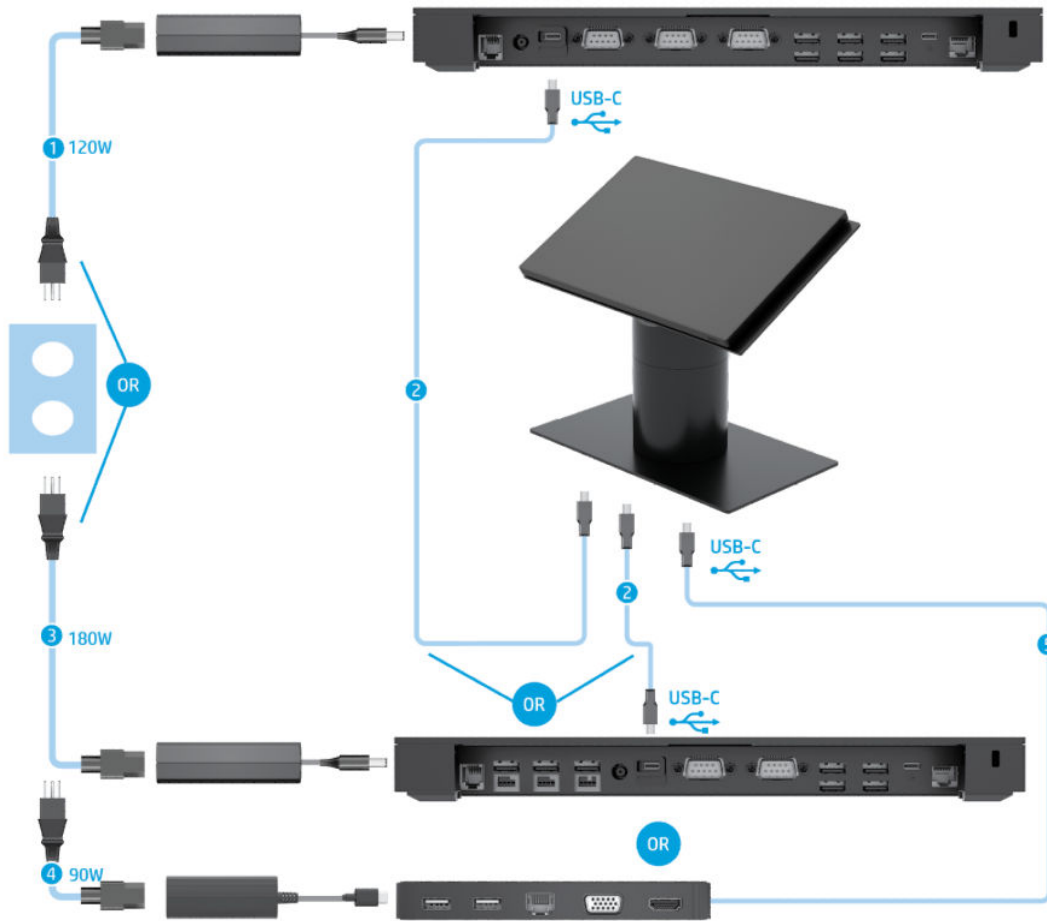

Cables

(1)	Basic I/O connectivity base 120 W AC power cord	(4)	USB-C mini dock 90 W AC power cord
(2)	I/O connectivity base USB Type-C cable	(5)	USB-C mini dock captive USB Type-C cable
(3)	Advanced I/O connectivity base 180 W AC power cord		



NOTE: In the European region, the USB-C mini dock is sold as an aftermarket option kit only. In all other regions, the USB-C mini dock is sold as drop-in-box option.

Cable matrix for Engage One with basic I/O connectivity base and standalone printer

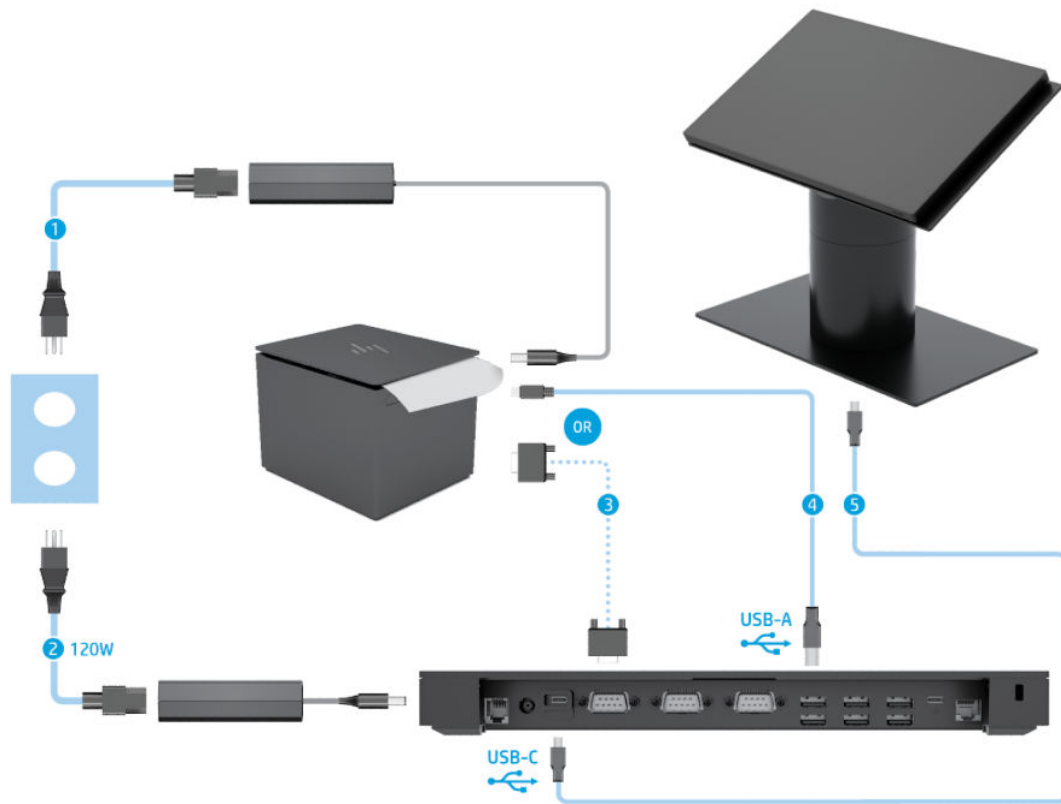

Cables

- | | | | |
|-----|---|-----|--|
| (1) | Printer AC power cord | (4) | Printer USB Type-A to Type-B data cable |
| (2) | Basic I/O connectivity base 120 W AC power cord | (5) | Basic I/O connectivity base USB Type-C cable |
| (3) | Printer serial data cable | | |

IMPORTANT: Connect either the serial data cable (3) or the USB Type-A data cable (4) between the I/O connectivity base and the printer. Do not connect both.

Cable matrix for Engage One with advanced I/O connectivity base and standalone printer

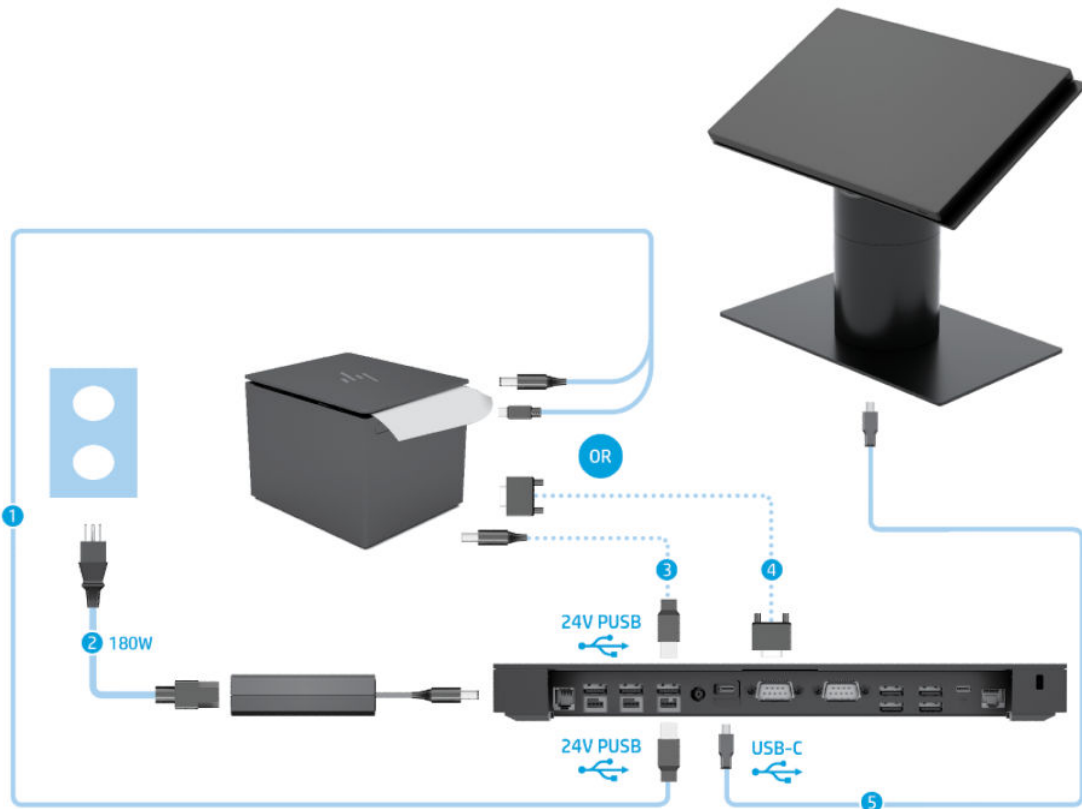

Cables

(1)	Printer 24 V PUSB power and data “Y” cable	(4)	Printer serial data cable
(2)	Advanced I/O connectivity base 180 W AC power adapter cord	(5)	Advanced I/O connectivity base USB Type-C cable
(3)	Printer 24 V PUSB power cable		

IMPORTANT: Connect either the 24 V PUSB power and data “Y” cable (1) or the 24 V PUSB power cable (3) and serial data cable (4) between the I/O connectivity base and the printer. Do not connect all three.

7 Configuring the software

Touch screen calibration for Windows 10 Professional and Windows 10 IoT Enterprise for Retail

 **NOTE:** The Windows calibration tool works only in digitizer touch mode. If you install a retail touch utility, it will set the touch screen to POS mode (mouse mode) by default and will not allow the Windows calibration tool to run.

To calibrate the touch module in Windows 10 Professional and Windows 10 IoT Enterprise for Retail:

1. Open Control Panel. You can type `Control Panel` in the Search box to access it.
2. In Control Panel, type `calibrate` in the Search box. Under **Tablet PC Settings**, tap the **Calibrate the screen for pen or touch input** link. In the **Tablet PC Settings** dialog box, tap the **Calibrate** button, and then proceed to step 3.
3. Follow the on-screen instructions to press the target marks on the touch screen. At the end of the calibration process, the touch module should be aligned with the video and the touch points will be accurate.

Configuring optional HP integrated peripheral modules

To configure the integrated USB peripheral, refer to the *HP Point of Sale Configuration Guide* (available in English only). The guide is located with the documentation on your retail computer and at <http://www.hp.com/support>. To access the guide on the retail computer, select **Start**, and then select **HP Point of Sale Information**.

 **NOTE:** Check <http://www.hp.com/support> for updated software or documentation that became available between the time your product was manufactured and the time it was delivered to you.

8 Computer Setup (F10) Utility

Computer Setup (F10) Utilities

Use Computer Setup (F10) Utility to do the following:

- Change factory default settings.
- View the system configuration, including settings for processor, graphics, memory, audio, storage, communications, and input devices.
- Modify the boot order of bootable devices such as hard drives, optical drives, or USB flash media devices.
- Select Post Messages Enabled or Disabled to change the display status of Power-On Self-Test (POST) messages. Post Messages Disabled suppresses most POST messages, such as memory count, product name, and other non-error text messages. If a POST error occurs, the error is displayed regardless of the mode selected. To manually switch to Post Messages Enabled during POST, press any key (except **F1** through **F12**).
- Establish an Ownership Tag, the text of which is displayed each time the system is turned on or restarted.
- Enter the Asset Tag or property identification number assigned by the company to this computer.
- Enable the power-on password prompt during system restarts (warm boots) as well as during power-on.
- Establish a setup password that controls access to the Computer Setup (F10) Utility and the settings described in this section.
- Secure integrated I/O functionality, including the serial, USB, or parallel ports, audio, or embedded NIC, so that they cannot be used until they are unsecured.
- Enable or disable removable media boot ability.
- Solve system configuration errors detected but not automatically fixed during the Power-On Self-Test (POST).
- Replicate the system setup by saving system configuration information on a USB device and restoring it on one or more computers.
- Enable or disable DriveLock security (when supported by drive).

Using Computer Setup (F10) Utilities

Computer Setup can be accessed only by turning the computer on or restarting the system. To access the Computer Setup Utilities menu, complete the following steps:

1. Turn on or restart the computer.
2. Repeatedly press **F10** when the monitor light turns green to access the utility.

You can also press **Esc** to a menu that allows you to access different options available at startup, including the Computer Setup utility.

 **NOTE:** If you do not press **F10** at the appropriate time, you must restart the computer and again repeatedly press **F10** when the monitor light turns green to access the utility.

3. A choice of four headings appears in the Computer Setup Utilities menu: Main, Security, Advanced, and UEFI Drivers.



NOTE: Selecting UEFI Drivers restarts the computer into the 3rd party option ROM management application. You can access this application directly by pressing **F3** during startup.

4. Use the arrow (left and right) keys to select the appropriate heading. Use the arrow (up and down) keys to select the option you want, then press **Enter**. To return to the Computer Setup Utilities menu, press **Esc**.
5. To apply and save changes, select **Main > Save Changes and Exit**.
 - If you have made changes that you do not want applied, select **Ignore Changes and Exit**.
 - To reset to factory settings or previously saved default settings (some models), select **Apply Factory Defaults and Exit**. This option will restore the original factory system defaults.



NOTE: Not all settings shown in the following sections are available for all models



CAUTION: Do NOT turn the computer power OFF while the BIOS is saving the Computer Setup (F10) changes because the CMOS could become corrupted. It is safe to turn off the computer only after exiting the F10 Setup screen.

Computer Setup—Main



NOTE: Support for specific Computer Setup options may vary depending on the hardware configuration.

Table 8-1 Computer Setup—Main

Option	Description
System Information	<p>Lists all information in following list if Advanced System Information is selected. Lists smaller subset if Basic System Information is selected.</p> <ul style="list-style-type: none">• Product Name• Memory Size• Processor Type• Processor Cache Size• Processor Speed• MicroCode Revision• Processor Stepping• Memory Speed• DIMM 1 Size• DIMM 3 Size• System BIOS version• ME Firmware Version• Reference Code Revision• Video BIOS Version• Super I/O Firmware Version• USB Type-C Controller(s) Firmware Version• Born On Date• Serial Number• SKU number• UUID (Universally Unique Identifier)• Asset Tracking Number• Feature Byte• Build ID• Product Family• System Board ID• System Board CT
System Diagnostics	<p>Starts HP PC Hardware Diagnostics UEFI.</p> <p>Lets you perform the following functions:</p> <ul style="list-style-type: none">• Memory Test• Hard Drive Check• Language
Update System BIOS	<p>Displays current BIOS information.</p>

Table 8-1 Computer Setup—Main (continued)

Option	Description
	<p>Check HP.com for BIOS Updates</p> <p>Checks for the latest BIOS release revision on the network, and lets you decide whether to download the BIOS image and update the system.</p> <p>Lock BIOS Version</p> <p>Clear to allow BIOS updates. Select to block BIOS updates.</p> <p>BIOS Rollback Policy</p> <ul style="list-style-type: none"> • Unrestricted Rollback to older BIOS • Restricted Rollback to older BIOS <p>Allow BIOS Updates Using a Network</p> <p>Select to enable scheduled automatic BIOS updates through the network.</p> <p>BIOS Update Preferences</p> <p>Lets you configure BIOS updates through the network.</p> <ul style="list-style-type: none"> • Check for Update on Next Reboot • BIOS Source – select the source of the BIOS update from either HP.com or a custom URL. • Automatic BIOS Update Setting – select how BIOS is updated. <p>NOTE: BitLocker Drive Encryption (BDE) must be temporarily suspended to be able to flash the BIOS.</p> <ul style="list-style-type: none"> • BIOS Update Frequency – select how often the BIOS is updated. This setting is not active if Automatic BIOS Update Setting is set to 'Do no update'. <p>Network Configuration Settings</p> <p>Lets you configure upload and download settings.</p> <ul style="list-style-type: none"> • Proxy Server – select to enable use of a proxy server. • Edit Proxy Server – If Proxy Server is enabled, lets you specify the server address in <server>:<port> format. • Test Network Connection – select to check the network connection based on the selection in Automatic BIOS Update Setting. • IPv4 Configuration – select 'Automatic' or 'Manual'. If 'Manual' is selected, you can configure the address, subnet mask, and gateway. • DNS Configuration – select 'Automatic' or 'Manual'. If 'Manual' is selected, you can entered a list of DNS addresses. • Data transfer timeout – lets you configure the timeout setting. Select Force HTTP no-cache to disable HTTP caching. <p>Update BIOS Using Local Media</p> <p>Lets you update the system BIOS. BIOS update binary (BIN) files must be located on the system hard drive or on a removable USB drive under the “Hewlett-Packard\BIOS\New” folder or under the “EFI\HP\BIOS\New” folder. The files can also be placed in the “Hewlett-Packard\BIOS\Previous” folder or under the “EFI\HP\BIOS\Previous” folder.</p>
Change Date and Time	Lets you update system date and time.
System IDs	<p>Lets you clear the following values:</p> <ul style="list-style-type: none"> • Asset Tracking Number • Ownership Tag

Table 8-1 Computer Setup—Main (continued)

Option	Description
Replicated Setup	<p>Backup current settings to USB device</p> <p>Saves system configuration to a formatted USB flash media device.</p> <p>Restore current settings from USB device</p> <p>Restores system configuration from a USB flash media device.</p>
Save Custom Defaults	Saves the current system configuration settings as the default.
Apply Custom Defaults and Exit	Applies the currently selected default settings and clears any established passwords.
Apply Factory Defaults and Exit	Restores the factory system configuration settings as the default.
Ignore Changes and Exit	Exits Computer Setup without applying or saving any changes.
Save Changes and Exit	Saves changes to system configuration or default settings and exits Computer Setup.
Suppress POST Errors	<p>Suppresses most system messages during POST (Power On Self Test).</p> <p>POST error messages are displayed on the display during the Power On Self Test if the BIOS encounters a problem while starting the computer. A POST error message will only display on screen if the computer is capable of booting this far. If the POST detects an error before this point, a beep code is generated instead.</p>

Computer Setup—Security



NOTE: Support for specific Computer Setup options may vary depending on the hardware configuration.

Table 8-2 Computer Setup—Security

Option	Description
Create BIOS Administrator Password	<p>Lets you set and enable a BIOS administrator password, which includes the following privileges:</p> <ul style="list-style-type: none"> • Manage other BIOS users • Full access to BIOS policy and settings • Control BIOS access of other users by setting security level • Unlock the computer when other BIOS users fail the preboot authentication. <p>NOTE: Creating a BIOS user disables the Fast Boot option.</p> <p>NOTE: If the password is set, it is required to change Computer Setup options, flash the ROM, and make changes to certain plug and play settings under Windows.</p>
Change BIOS Administrator Password (This selection is active only if a BIOS administrator password is set.)	<p>Lets you change the BIOS administrator password.</p> <p>You must know the current password to be able to change it.</p>
Password Policies	<p>Let you set the guidelines for a valid password. Options include:</p> <ul style="list-style-type: none"> • Password minimum length • Requires at least one symbol

Table 8-2 Computer Setup—Security (continued)

Option	Description
	<ul style="list-style-type: none">• Requires at least one number• Requires at least one upper case character• Requires at least one lower case character• Allow spaces <p>Clear Password Jumper</p> <p>Select 'Honor' to engage or 'Ignore' to disengage the password jumper. Default is 'Honor'.</p>
TPM Embedded Security	<p>Displays the TPM specification version.</p> <p>Lets you configure the following TPM settings:</p> <p>TPM Device</p> <p>Lets you set the Trusted Platform Module as available or hidden.</p> <p>TPM State</p> <p>Select to enable the TPM.</p> <p>Clear TPM</p> <p>Select to reset the TPM to an unowned state. After the TPM is cleared, it is also turned off. To temporarily suspend TPM operations, turn the TPM off instead of clearing it.</p> <p>CAUTION: Clearing the TPM resets it to factory defaults and turns it off. You will lose all created keys and data protected by those keys.</p>
BIOS SureStart	<p>HP Sure Start verifies the integrity of HP BIOS code and critical, non-executable platform data residing in the main flash and provides self-healing mechanisms to restore any code or critical platform data that has been lost or is corrupted within the flash.</p> <p>Verify Boot Block on every boot</p> <p>Disabled (Default): When set to the default, HP Sure Start will verify the integrity of the BIOS in System Flash each time the system is in a Sleep, Hibernate, or Off state such that assurance is provided that it has not been tampered with before the host CPU executes that code as part of the process of resuming from the low power state.</p> <p>Enabled: When this box is checked, the HP Sure Start will continue to verify the integrity of the BIOS in System Flash each time the system is in a Sleep, Hibernate, or Off state. Additionally, the HP Sure Start will verify the integrity of the BIOS in System Flash on each Warm Boot (Windows Restart).</p> <p>BIOS Data Recovery Policy</p> <p>Automatic (Default): Any problems that are found by HP Sure Start will be automatically repaired not requiring any special actions by the local user.</p> <p>Manual (For Advanced Users only): Any problems found by HP Sure Start will not be repaired automatically and will require a special key sequence input by the local user to proceed with the repair. This mode is only intended for scenarios where the machine owner would prefer to perform forensics on the system flash contents before it is repaired and is not recommended for the typical user. In the case of HP Sure Start finding an issue with the initial BIOS code, the system will refuse to boot and flash a special LED sequence until the special key sequence is pressed on the internal keyboard.</p> <p>Network Controller Configuration Restore – This manual control will restore the network parameters (used by the Intel integrated network controller) stored in System Flash to their factory defaults.</p> <p>Dynamic Runtime Scanning of Boot Block</p> <p>Select to enable.</p>
Intel Software Guard Extensions (SGX)	<p>Let you enable or disable software guard extensions.</p>

Table 8-2 Computer Setup—Security (continued)

Option	Description
Hard Drive Utilities	<p>Save/Restore MBR of System Hard Drive</p> <p>Enable to save the Master Boot Record (MBR) of the hard drive. If the MBR gets changed, the user is prompted to authorize restoring the MBR.</p> <p>DriveLock</p> <p>Allows you to assign or modify a master or user password for hard drives. When this feature is enabled, the user is prompted to provide one of the DriveLock passwords during POST. If neither is successfully entered, the hard drive will remain inaccessible until one of the passwords is successfully provided during a subsequent cold-boot sequence.</p> <p>NOTE: This selection will only appear when at least one drive that supports the DriveLock feature is attached to the system.</p> <p>CAUTION: Be aware that these settings take place immediately. A save is not necessary.</p> <p>CAUTION: Be sure to document the DriveLock password. Losing a DriveLock password will render a drive permanently locked.</p> <p>After you select a drive, the following options are available:</p> <ul style="list-style-type: none"> • Set DriveLock Master Password. Sets the drive's master password but does not enable DriveLock. • Enable DriveLock. Sets the drive's user password and enables DriveLock. <p>Secure Erase</p> <p>Lets you select a hard drive to completely erase. Once a hard drive has been erased with a program that utilizes Secure Erase firmware commands, no file recovery program, partition recovery program, or other data recovery method will be able to extract data from the drive.</p>
System Management Command	Allows authorized personnel to reset security settings during a service event. Default is enabled.
Restore Security Settings to Default	Restoring settings to default requires the BIOS Administrator password.

Computer Setup—Advanced



NOTE: Support for specific Computer Setup options may vary depending on the hardware configuration.

Table 8-3 Computer Setup—Advanced (for advanced users)

Option	Description
Display Language	Lets you select the language of the menus in F10 Setup and the keyboard.
Scheduled Power-On	This feature wakes the system up from a powered off state at a specified date and time.
Boot Options	<p>Startup Menu Delay (sec)</p> <p>Enabling this feature will add a user-specified delay to the POST process. This delay is sometimes needed for hard disks on some PCI cards that spin up very slowly, so slowly that they are not ready to boot by the time POST is finished. The POST delay also gives you more time to select F10 to enter Computer (F10) Setup. Default is '0'.</p> <p>Select the devices that the computer can boot from, as well as other options, including:</p> <ul style="list-style-type: none"> • Fast Boot. Default is disabled. • USB Storage Boot. Default is enabled. • Network (PXE) Boot. Default is enabled.

Table 8-3 Computer Setup—Advanced (for advanced users) (continued)

Option	Description
	<ul style="list-style-type: none"> • After Power Loss (off/on/previous state). Default is Power off. Setting this option to: <ul style="list-style-type: none"> ○ Power off—causes the computer to remain powered off when power is restored. ○ Power on—causes the computer to power on automatically as soon as power is restored. ○ Previous state—causes the computer to power on automatically as soon as power is restored, if it was on when power was lost. • Prompt on Memory Size Change. Default is enabled. • Prompt on Fixed Storage Change. Default is disabled. • Audio Alerts During Boot. Default is enabled. • NumLock on at boot. Default is enabled. • UEFI Boot Order. Default is enabled. • Specify the order in which UEFI boot sources (such as a internal hard drive, USB hard drive, USB optical drive, or internal optical drive) are checked for a bootable operating system image. Each device on the list may be individually excluded from or included for consideration as a bootable operating system source. UEFI boot sources always have precedence over legacy boot sources. • Legacy Boot Order Specify the order in which legacy boot sources (such as a network interface card, internal hard drive, USB optical drive, or internal optical drive) are checked for a bootable operating system image. Each device on the list may be individually excluded from or included for consideration as a bootable operating system source. Specify the order of attached hard drives. The first hard drive in the order will have priority in the boot sequence and will be recognized as drive C (if any devices are attached). NOTE: To drag a device to a preferred place, press Enter. To remove the device from consideration as a bootable device, press F5. You can use F5 to disable individual boot items, as well as disable UEFI boot and/or legacy boot. NOTE: MS-DOS drive lettering assignments may not apply after a non-MS-DOS operating system has started. Shortcut to Temporarily Override Boot Order To boot one time from a device other than the default device specified in Boot Order, restart the computer and press Esc (to access the boot menu) and then F9 (Boot Order), or only F9 (skipping the boot menu) when the monitor light turns green. After POST is completed, a list of bootable devices is displayed. Use the arrow keys to select the preferred bootable device and press Enter. The computer then boots from the selected non-default device for this one time.
Secure Boot Configuration	<p>Configure Legacy Support and Secure Boot</p> <p>Legacy Support – Lets you turn off all legacy support on the computer, including booting to DOS, running legacy graphics cards, booting to legacy devices, and so on.</p> <p>Secure Boot – Lets you make sure an operating system is legitimate before booting to it, making Windows resistant to malicious modification from preboot to full OS booting, preventing firmware attacks. UEFI and Windows Secure Boot only allow code signed by pre-approved digital certificates to run during the firmware and OS boot process.</p> <p>Default is 'Legacy Support Enable and Secure Boot Disable'.</p> <p>Secure Boot Key Management</p> <p>Lets you manage the custom key settings.</p> <p>Clear Secure Boot Keys</p>

Table 8-3 Computer Setup—Advanced (for advanced users) (continued)

Option	Description
	<p>Lets you delete any previously loaded custom boot keys. Clearing keys will disable secure boot. Default is disabled.</p> <p>Reset Security Boot keys to factory defaults</p> <p>Default is disabled.</p> <p>Enable MS UEFI CA key</p> <p>Lets you enabled the Certification Authority key. Default is enabled.</p> <p>Ready BIOS for Device Guard Use</p> <p>Requires BIOS Administrator password to be configured and Secure Boot to be enabled.</p>
System Options	<p>Hyperthreading</p> <p>Lets you control processor capability.</p> <p>Virtualization Technology (VTx)</p> <p>Enables the virtualization features of the processor. Changing this setting requires turning the computer off and then back on. Default is disabled.</p> <p>Virtualization Technology for Directed IO (VTd)</p> <p>Grants virtual machines direct access to peripheral devices on select Intel-based systems. Default is disabled.</p> <p>M.2 WLAN/BT</p> <p>Select to show the device in the operating system. Default is enabled.</p> <p>M.2 SSD</p> <p>Select to show the device in the operating system. Default is enabled.</p> <p>Allow PCIe/PCI SERR# Interrupt</p> <p>Allows PCI devices to report PCI/PCIe System Error signals, such as address parity errors, data parity errors, and critical errors other than parity. Default is enabled.</p> <p>Power Button Override (disable/4 sec/15 sec)</p> <p>Lets you disable or enable and select the number of seconds you have to hold down the power button for it to override the system. Default is '4 sec'.</p>
Built-In Device Options	<p>Embedded LAN Controller</p> <p>Select to show the device in the operating system. Default is enabled.</p> <p>Wake On LAN</p> <p>Lets you either disable the Wake On LAN feature, or configure where the computer boots, including the network or hard drive. Default is Boot to Network.</p> <p>Video memory size</p> <p>Choose either 32 MB, 64 MB, 128 MB, 256 MB, or 512 MB. Default is 32 MB.</p> <p>Touch Device</p> <p>Select to show the device in the operating system. Default is enabled.</p> <p>Audio Device</p> <p>Select to show the device in the operating system. Default is enabled.</p> <p>Internal Speakers (does not affect external speakers)</p> <p>Select to show the device in the operating system. Default is enabled.</p>

Table 8-3 Computer Setup—Advanced (for advanced users) (continued)

Option	Description
	<p>Headphone output (does not affect external speakers)</p> <p>Select to allow sound to go to headphones. Default is enabled.</p> <p>Increase Idle Fan Speed(%)</p> <p>Sets idle fan speed percentage. This setting only changes the minimum fan speed. The fan is still automatically controlled.</p> <p>M.2 USB/Bluetooth</p> <p>Select to show the device in the operating system. Default is enabled.</p>
Port Options	<p>Allows you to configure specific ports and show or hide ports from the operating system. Clear the box to hide a device.</p> <ul style="list-style-type: none"> • Serial port A • Serial port B • Bottom I/O non-powered USB ports – all • USB 3.0 Port 1 • USB 3.0 Port 2 • USB 2.0 Port 3 • USB 2.0 Port 4 • USB 2.0 Port 5 • USB 2.0 Port 6 • SATA0 • SATA1 • SATA4 • Bottom USB Type-C port • Media card reader • Cash Drawer Port • USB Type-C Controller Firmware Update
Option ROM Launch Policy	<p>These policies control whether the Legacy Option ROM or the UEFI driver is loaded. Default is 'All UEFI'.</p> <p>Configure Option ROM Launch Policy</p> <ul style="list-style-type: none"> • All legacy • All UEFI • All UEFI except video
Power Management Options	<p>Runtime Power Management (enable/disable)</p> <p>Allows certain operating systems to reduce processor voltage and frequency when the current software load does not require the full capabilities of the processor. Default is enabled.</p> <p>Extended Idle Power States (enable/disable)</p> <p>Allows certain operating systems to decrease the processors power consumption when the processor is idle. Default is enabled.</p> <p>S5 Maximum Power Savings (enable/disable)</p>

Table 8-3 Computer Setup—Advanced (for advanced users) (continued)

Option	Description
	Enabling this feature reduces the power of the system as much as possible in the S5 state. Power is removed from the wake up circuitry, the expansion slots, and any management features while in S5. Default is disabled.
	SATA Power Management (enable/disable)
	Enables or disables SATA bus and/or device power management. Default is enabled.
	PCI Express Power Management (enable/disable)
	Enabling this option permits the PCI Express links to use Active Power State Management (ASPM) to enter lower power states while not in use. Default is enabled.
	Unique Sleep State Blink Rates (enable/disable)
	This feature is designed to provide a visual indication of what sleep state the system is in. Each sleep state has a unique blink pattern. Default is disabled.
	NOTE: A normal shutdown goes to the S4 state.
	S0 (On) = Solid white LED.
	S3 (Stand By)= 3 blinks at 1Hz (50% duty cycle) followed by a pause of 2 seconds (white LED) — repeated cycles of 3 blinks and a pause.
	S4 (Hibernation)= 4 blinks at 1Hz (50% duty cycle) followed by a pause of 2 seconds (white LED) — repeated cycles of 4 blinks and a pause.
	S5 (Soft Off) = LED is off.

Recovering the Configuration Settings

This method of recovery requires that you first perform the **Save to Removable Media** command with the Computer Setup (F10) Utility before **Restore** is needed. (See [Computer Setup—Main on page 79](#) in the Computer Setup—File table.)



NOTE: It is recommended that you save any modified computer configuration settings to a USB flash media device and save the device for possible future use.

To restore the configuration, insert the USB flash media device with the saved configuration and perform the **Restore from Removable Media** command with the Computer Setup (F10) Utility. (See [Computer Setup—Main on page 79](#) in the Computer Setup—File table.)

9 POST error messages and diagnostic front panel LEDs and audible codes

This appendix lists the error codes, error messages, and the various indicator light and audible sequences that you may encounter during Power-On Self-Test (POST) or computer restart, the probable source of the problem, and steps you can take to resolve the error condition.

POST Message Disabled suppresses most system messages during POST, such as memory count and non-error text messages. If a POST error occurs, the screen will display the error message. To manually switch to the POST Messages Enabled mode during POST, press any key (except **F10**, **F11**, or **F12**). The default mode is POST Message Disabled.

The speed at which the computer loads the operating system and the extent to which it is tested are determined by the POST mode selection.

Quick Boot is a fast startup process that does not run all of the system level tests, such as the memory test. Full Boot runs all of the ROM-based system tests and takes longer to complete.

Full Boot may also be enabled to run every 1 to 30 days on a regularly scheduled basis. To establish the schedule, reconfigure the computer to the Full Boot Every x Days mode, using Computer Setup.



NOTE: For more information on Computer Setup, see [Computer Setup \(F10\) Utility on page 77](#).

POST numeric codes and text messages

This section covers those POST errors that have numeric codes associated with them. The section also includes some text messages that may be encountered during POST.



NOTE: The computer will beep once after a POST text message is displayed on the screen.

Control panel message	Description	Recommended action
002-Option ROM Checksum Error	System ROM or expansion board option ROM checksum.	<ol style="list-style-type: none">1. Verify the correct ROM.2. Flash the ROM if needed.3. If an expansion board was recently added, remove it to see if the problem remains.4. Clear CMOS. (See Password security and resetting CMOS on page 95.)5. If the message disappears, there may be a problem with the expansion card.6. Replace the system board.
003-System Board Failure	DMA or timers.	<ol style="list-style-type: none">1. Clear CMOS. (See Password security and resetting CMOS on page 95.)2. Remove expansion boards.3. Replace the system board.
005-Real-Time Clock Power Loss	Invalid time or date in configuration memory.	Reset the date and time under Control Panel (Computer Setup can also be used). If the

Control panel message	Description	Recommended action
	RTC (real-time clock) battery may need to be replaced.	problem persists, replace the RTC battery. See the Removal and Replacement section for instructions on installing a new battery.
008–Microcode Patch Error	Processor is not supported by the BIOS.	<ol style="list-style-type: none"> 1. Upgrade BIOS to proper version. 2. Change the processor.
009–PMM Allocation Error during MEBx Download	Memory error during POST execution of the Management Engine (ME) BIOS Extensions option ROM.	<ol style="list-style-type: none"> 1. Reboot the computer. 2. Unplug the power cord, re-seat the memory modules, and reboot the computer. 3. If the memory configuration was recently changed, unplug the computer, restore the original memory configuration, and reboot the computer. 4. If the error persists, replace the system board.
100-Front Audio Not Connected	Front audio cable has been detached or unseated from system board.	Reconnect or replace front audio cable.
00A-Product Information Not Valid	The product information programmed into the system board is missing or invalid.	Use Computer Setup to update this information.
00B-MEBx Module did not checksum correctly	Memory error during POST execution of the Management Engine (ME) BIOS Extensions option ROM.	<ol style="list-style-type: none"> 1. Reboot the computer. 2. Unplug the power cord, re-seat the memory modules, and reboot the computer. 3. If the memory configuration was recently changed, unplug the power cord, restore the original memory configuration, and reboot the computer. 4. If the error persists, replace the system board.
00C-PMM Deallocation Error during MEBx Cleanup	Memory error during POST execution of the Management Engine (ME) BIOS Extensions option ROM.	<ol style="list-style-type: none"> 1. Reboot the computer. 2. Unplug the power cord, re-seat the memory modules, and reboot the computer. 3. If the memory configuration was recently changed, unplug the power cord, restore the original memory configuration, and reboot the computer. 4. If the error persists, replace the system board.
00D-Setup Error during MEBx Execution	MEBx selection or exit resulted in a setup failure.	<ol style="list-style-type: none"> 1. Reboot the computer. 2. Unplug the power cord, re-seat the memory modules, and reboot the computer. 3. If the memory configuration was recently changed, unplug the power cord, restore the original memory configuration, and reboot the computer.

Control panel message	Description	Recommended action
		<ol style="list-style-type: none"> 4. If the error persists, replace the system board.
00E-Inventory Error during MEBx Execution	BIOS information passed to the MEBx resulted in a failure.	<ol style="list-style-type: none"> 1. Reboot the computer. 2. If the error persists, update to the latest BIOS version. 3. If the error still persists, replace the system board.
00F-Interface Error during MEBx Execution	MEBx operation experienced a hardware error during communication with the ME.	<ol style="list-style-type: none"> 1. Reboot the computer. 2. If the error persists, update to the latest BIOS version. 3. If the error still persists, replace the system board.
2E1-MemorySize Error	Memory amount has changed since the last boot (memory added or removed).	The system memory size is different from the last startup. The most common reason is the removal of memory from the system board. Press the F1 key to save the memory changes. If this message persists, verify that the memory modules are installed correctly.
2E2-Memory Error	Memory module configuration failed during boot up.	<ol style="list-style-type: none"> 1. Ensure memory modules are correctly installed. 2. Verify proper memory module type. 3. Remove and replace the identified faulty memory module(s). 4. If the error persists after replacing memory modules, replace the system board.
2E3-Incompatible Memory Module in Memory Socket(s) X, X, ...	A memory module in memory socket identified in the error message is missing critical SPD information, or is incompatible with the chipset.	<ol style="list-style-type: none"> 1. Verify proper memory module type. 2. Try another memory socket. 3. Replace with a supported module.
2E4-DIMM Configuration Warning	The current memory configuration is not optimized.	Rearrange the DIMMs so that each channel has the same amount of memory.
2E5-ECC Memory Module Detected on Unsupported Platform	Recently added memory module(s) support ECC memory error correction.	<ol style="list-style-type: none"> 1. If additional memory was recently added, remove it to see if the problem remains. 2. Check product documentation for memory support information.
2E6-Memory Not Configured Correctly for Proper MEBx Execution	DIMM1 is not installed.	Make sure there is a memory module in the DIMM1 socket and that it is properly seated.
300-Configuration Change Warning	The storage device configuration will be updated as shown.	Not applicable
301-Hard Disk 1: SMART Hard Drive Detects Imminent Failure	Hard drive is about to fail. (Some hard drives have a hard drive firmware patch that will fix an erroneous error message.)	<ol style="list-style-type: none"> 1. Determine if hard drive is giving correct error message. Run the Drive Protection System test under using F2 Diagnostics when booting the computer. 2. Apply hard drive firmware patch if applicable. (Available at http://www.hp.com/support.)

Control panel message	Description	Recommended action
302-Hard Disk 2: SMART Hard Drive Detects Imminent Failure	Hard drive is about to fail. (Some hard drives have a hard drive firmware patch that will fix an erroneous error message.)	<ol style="list-style-type: none"> 1. Determine if hard drive is giving correct error message. Run the Drive Protection System test under using F2 Diagnostics when booting the computer. 2. Apply hard drive firmware patch if applicable. (Available at http://www.hp.com/support.) 3. Back up contents and replace hard drive.
309 – 30C: Hard Disk 3–6: SMART Hard Drive Detects Imminent Failure	Hard drive is about to fail. (Some hard drives have a hard drive firmware patch that will fix an erroneous error message.)	<ol style="list-style-type: none"> 1. Determine if hard drive is giving correct error message. Run the Drive Protection System test under using F2 Diagnostics when booting the computer. 2. Apply hard drive firmware patch if applicable. (Available at http://www.hp.com/support.) 3. Back up contents and replace hard drive.
3F0–Boot Device Not Found	Boot device not found.	Insert boot device or load operating system.
3F1–Hard Disk 1 Error	Hard disk 1 error.	<ol style="list-style-type: none"> 1. Check and/or replace cables. 2. Clear CMOS. (See Password security and resetting CMOS on page 95.) 3. Replace the hard disk drive.
3F2–Hard Disk 2 Error	Hard disk 2 error.	<ol style="list-style-type: none"> 1. Check and/or replace cables. 2. Clear CMOS. (See Password security and resetting CMOS on page 95.) 3. Replace the hard disk drive.
400–Serial Port A Address Conflict Detected	Both external and internal serial ports are assigned to the same resources.	<ol style="list-style-type: none"> 1. Remove any serial port expansion cards. 2. Clear CMOS. (See Password security and resetting CMOS on page 95.) 3. Reconfigure card resources and/or run Computer Setup or Windows utilities.
401–Serial Port B Address Conflict Detected	Both external and internal serial ports are assigned to the same resources.	<ol style="list-style-type: none"> 1. Remove any serial port expansion cards. 2. Clear CMOS. (See Password security and resetting CMOS on page 95.) 3. Reconfigure card resources and/or run Computer Setup or Windows utilities.
402–Serial Port C Address Conflict Detected	Both external and internal serial ports are assigned to the same resources.	<ol style="list-style-type: none"> 1. Remove any serial port expansion cards. 2. Clear CMOS. (See Password security and resetting CMOS on page 95.) 3. Reconfigure card resources and/or run Computer Setup or Windows utilities.
403–Serial Port D Address Conflict Detected	Both external and internal serial ports are assigned to the same resources.	<ol style="list-style-type: none"> 1. Remove any serial port expansion cards. 2. Clear CMOS. (See Password security and resetting CMOS on page 95.)

Control panel message	Description	Recommended action
		<ol style="list-style-type: none"> 3. Reconfigure card resources and/or run Computer Setup or Windows utilities.
419-Out of Memory Space for Option ROMs	Recently added PCI expansion card contains an option ROM too large to download during POST.	<p>▲ If a PCI expansion card was recently added, remove it to see if the problem remains.</p>
41A-Front USB1/USB2 Not Connected	Front USB cable has been detached or unseated from system board.	Reconnect or replace front USB cable.
41B-Device in PCI Express Slot Failed To Initialize	There is an incompatibility or problem with a PCIe device and the system or PCIe link could not be configured to a valid bus width or speed.	Try rebooting the system. If the error reoccurs, the device may not work with this system
43A-USB Type-C I2C Not Connected	Cable is required between I2C on card and USB-C on the system board.	Install cable between I2C on card and USB-C on the system board.
43B-More Than One USB type-C Cards Are Installed	More than one USB type-C card is installed.	Remove USB type-C card so only one is installed.
500-BIOS Recovery	A system BIOS recovery has occurred.	Not applicable.
60x-HP Battery Alert	The system has detected the storage capacity of the battery stated below to be very low.	For optimal performance, replace the battery.
70x-Wireless Mode Not Supported	The system has detected a wireless module installed in the system that is not supported and has been disabled.	Replace with a supported module.
800-Keyboard Error	Keyboard failure.	<ol style="list-style-type: none"> 1. Reconnect keyboard with computer turned off. 2. Check connector for bent or missing pins. 3. Ensure that none of the keys are depressed. 4. Replace keyboard.
801-Keyboard or System Unit Error	Keyboard failure.	<ol style="list-style-type: none"> 1. Reconnect the keyboard with computer turned off. 2. Ensure that none of the keys are depressed. 3. Replace the keyboard. 4. Replace the system board.
900-CPU Fan Not Detected	CPU fan is not connected or may have malfunctioned.	<ol style="list-style-type: none"> 1. Reseat CPU fan. 2. Reseat fan cable. 3. Replace CPU fan.
901-Chassis, Rear Chassis, or Front Chassis Fan not Detected	Chassis, rear chassis, or front chassis fan is not connected or may have malfunctioned.	<ol style="list-style-type: none"> 1. Reseat chassis, rear chassis, or front chassis fan. 2. Reseat fan cable. 3. Replace chassis, rear chassis, or front chassis fan.
904-SATA Cabling Error	One or more SATA devices are improperly attached. For optimal performance, the SATA 0 and SATA 1 ports should be used for hard drives before other ports.	Ensure SATA connectors are used in ascending order. For one device, use SATA 0. For two devices, use SATA 0 and SATA 1. For three devices, use SATA 0, SATA 1, and SATA 2.

Control panel message	Description	Recommended action
910-Filter Warning	Airflow filter is dirty.	Replace the airflow filter.
90B-Fan Failure	The system has detected that a cooling fan is not operating correctly.	<ol style="list-style-type: none"> 1. Reseat fan. 2. Reseat fan cable. 3. Replace fan.
90D-System Temperature	Thermal shutdown occurred. The system BIOS has detected your machine was previously shut down to avoid overheating. Overheating may occur if the cooling vents are blocked or the operating temperature exceeds the system specifications. The machine should return to normal operation once the situation is resolved.	Make sure system has proper airflow.
90E-Power Supply Fan Not detected	Power supply fan is not connected or may have malfunctioned.	<ol style="list-style-type: none"> 1. Reseat power supply fan. 2. Reseat fan cable. 3. Replace power supply fan.

Interpreting system validation diagnostic front panel LEDs and audible codes

During the system validation phase that occurs at system startup, the BIOS validates the functionality of the following subsystems and conditions:

- AC adapter
- System board power
- Processor failure
- BIOS corruption
- Memory failure
- Graphics failure
- System board failure
- BIOS authentication failure

If an error is detected, specific patterns of long and short blinks, accompanied by long and short beeps (where applicable) are used to identify the error. These patterns will make up a two part code:

- Major – the category of the error
- Minor – the specific error within the category



NOTE: Single beep/blink codes are not used.

Number of long beeps/blinks	Error category
1	Not used
2	BIOS
3	Hardware

Number of long beeps/blinks	Error category
4	Thermal
5	System board

Patterns of blink/beep codes are determined by using the following parameters:

- 1 second pause occurs after the last major blink.
- 2 second pause occurs after the last minor blink.
- Beep error code sequences occur for the first 5 iterations of the pattern and then stop.
- Blink error code sequences continue until the computer is unplugged or the power button is pressed.



NOTE: Not all diagnostic lights and audible codes are available on all models.

The red LED blinks to represent the major error category (long blinks). The white LED blinks to represent the minor error category (short blinks). For example, '3.5' indicates 3 long red blinks and 5 short white blinks to communicate the processor is not detected.

Category	Major/minor code	Description
BIOS	2.2	The main area (DXE) of BIOS has become corrupted and there is no recovery binary image available.
	2.3	The embedded controller policy requires the user to enter a key sequence.
	2.4	The embedded controller is checking or recovering the boot block.
Hardware	3.2	The embedded controller has timed out waiting for BIOS to return from memory initialization.
	3.3	The embedded controller has timed out waiting for BIOS to return from graphics initialization.
	3.4	The system board displays a power failure (crowbar).*
	3.5	The processor is not detected.*
	3.6	The processor does not support an enabled feature.
Thermal	4.2	A processor over temperature condition has been detected.*
	4.3	An ambient temperature over temperature condition has been detected.
	4.4	An MXM over temperature condition has been detected.
System board	5.2	The embedded controller cannot find valid firmware.
	5.3	The embedded controller has timed out waiting for the BIOS.
	5.4	The embedded controller has timed out waiting for BIOS to return from system board initialization.
	5.5	The embedded controller rebooted the system after a possible lockup condition had been detected through the use of a System Health Timer, Automated System Recovery Timer, or other mechanism.

* Indicates hardware triggered event; all other events are controlled by the BIOS.

10 Password security and resetting CMOS

This computer supports security password features, which can be established through the Computer Setup Utilities menu.

This computer supports two security password features that are established through the Computer Setup Utilities menu: setup password and power-on password. When you establish only a setup password, any user can access all the information on the computer except Computer Setup. When you establish only a power-on password, the power-on password is required to access Computer Setup and any other information on the computer. When you establish both passwords, only the setup password will give you access to Computer Setup.

When both passwords are set, the setup password can also be used in place of the power-on password as an override to log in to the computer. This is a useful feature for a network administrator.

If you forget the password for the computer, you can clear that password so you can gain access to the information on the computer by resetting the password jumper.

 **CAUTION:** Pushing the CMOS button will reset CMOS values to factory defaults. It is important to back up the computer CMOS settings before resetting them in case they are needed later. Back up is easily done through Computer Setup. See [Computer Setup \(F10\) Utility on page 77](#) for information on backing up the CMOS settings.

Resetting the password jumper

 **CAUTION:** If you enable the stringent security feature in Computer Setup and you forget the setup password or the power-on password, the computer is inaccessible and can no longer be used.

Enabling the stringent password disables the ability to reset the password by moving the jumper on the system board.

If you lose or forget the password, the system board must be replaced. This scenario is not covered under warranty.

To prevent the computer from becoming permanently unusable, record your configured setup password or power-on password in a safe place away from your computer. Without these passwords, the computer cannot be unlocked.

To disable the power-on or setup password features, or to clear the power-on or setup passwords, complete the following steps:

1. Shut down the operating system properly, then turn off the computer and any external devices, and disconnect the power cord from the power outlet.
2. With the power cord disconnected, press the power button again to drain the system of any residual power.

 **WARNING!** To reduce the risk of personal injury from electrical shock and/or hot surfaces, be sure to disconnect the power cord from the wall outlet, and allow the internal system components to cool before touching.

 **CAUTION:** When the computer is plugged in, the power supply always has voltage applied to the system board even when the unit is turned off. Failure to disconnect the power cord can result in damage to the system.

Static electricity can damage the electronic components of the computer or optional equipment. Before beginning these procedures, ensure that you are discharged of static electricity by briefly touching a grounded metal object. See the *Safety & Regulatory Information* guide for more information.

3. Remove the access panel.
4. Locate the header and jumper.

 **NOTE:** The password jumper is blue so that it can be easily identified. For assistance locating the password jumper and other system board components, see the system board components image at [Removing the system board on page 59](#).

5. Remove the jumper from pins 1 and 2.
6. Place the jumper on either pin 1 or 2, but not both, so that it does not get lost.
7. Replace the access panel and reconnect the external equipment.
8. Plug in the computer and turn on power. Allow the operating system to start. This clears the current passwords and disables the password features.
9. Shut down the computer, unplug the power, and disconnect the external equipment.
10. Remove the access panel.
11. Place the jumper on pins 1 and 2.
12. Replace the access panel.
13. Reconnect the external equipment and plug in the computer.

Changing a Setup or Power-On password

To change the power-on or setup password, complete the following steps:

1. Turn on or restart the computer.
 - To change the Setup password, go to step 2.
 - To change the Power-on password, go to step 3.
2. To change the Setup password, as soon as the computer turns on:
 - Press the Esc key while “Press the ESC key for Startup Menu” message is displayed.
 - Press the F10 key to enter Computer Setup.

3. When the key icon appears, type your current password, a slash (/) or alternate delimiter character, your new password, another slash (/) or alternate delimiter character, and your new password again as shown:

current password/new password/new password



NOTE: Type the new password carefully since the characters do not appear on the screen.

4. Press **Enter**.

The new password will take effect the next time the computer is restarted.

Deleting a Setup or Power-On password

To delete the power-on or setup password, complete the following steps:

1. Turn on or restart the computer.
To delete the Setup password, go to step 2.
To delete the Power-on password, go to step 3.
2. To delete the Setup password, as soon as the computer turns on:
 - Press the Esc key while “Press the ESC key for Startup Menu” message is displayed.
 - Press the F10 key to enter Computer Setup.
3. When the key icon appears, type your current password, a slash (/) or alternate delimiter character, your new password, another slash (/) or alternate delimiter character, and your new password again as shown:
current password/
4. Press **Enter**.

Clearing and resetting the CMOS

The computer’s configuration memory (CMOS) stores information about the computer’s configuration.

The CMOS button resets CMOS but does not clear the power-on and setup passwords.

1. Turn off the computer and any external devices, and disconnect the power cord from the power outlet.
2. Disconnect external equipment connected to the computer.



WARNING! To reduce the risk of personal injury from electrical shock and/or hot surfaces, be sure to disconnect the power cord from the wall outlet, and allow the internal system components to cool before touching.



CAUTION: When the computer is plugged in, the power supply always has voltage applied to the system board even when the unit is turned off. Failure to disconnect the power cord can result in damage to the system.

Static electricity can damage the electronic components of the computer or optional equipment. Before beginning these procedures, ensure that you are discharged of static electricity by briefly touching a grounded metal object. See the *Safety & Regulatory Information* guide for more information.

3. Remove the access panel.

CAUTION: Pushing the CMOS button will reset CMOS values to factory defaults. It is important to back up the computer CMOS settings before resetting them in case they are needed later. Back up is easily done through Computer Setup. See [Computer Setup \(F10\) Utility on page 77](#) for information on backing up the CMOS settings.

4. Locate, press, and hold the CMOS button in for five seconds.

NOTE: Make sure you have disconnected the AC power cord from the wall outlet. The CMOS button will not clear CMOS if the power cord is connected.



NOTE: For assistance locating the CMOS button and other system board components, see the system board components image at [Removing the system board on page 59](#).

5. Replace the access panel.
6. Reconnect the external devices.
7. Plug in the computer and turn on power.

NOTE: You will receive POST error messages after clearing CMOS and rebooting advising you that configuration changes have occurred. Use Computer Setup to reset any special system setups along with the date and time.

For instructions on Computer Setup, see [Computer Setup \(F10\) Utility on page 77](#).

11 Using HP PC Hardware Diagnostics (UEFI)

HP PC Hardware Diagnostics is a Unified Extensible Firmware Interface (UEFI) that allows you to run diagnostic tests to determine whether the computer hardware is functioning properly. The tool runs outside the operating system so that it can isolate hardware failures from issues that are caused by the operating system or other software components.

When HP PC Hardware Diagnostics (UEFI) detects a failure that requires hardware replacement, a 24-digit Failure ID code is generated. This ID code can then be provided to support to help determine how to correct the problem.

 **NOTE:** To start diagnostics on a convertible computer, your computer must be in notebook mode and you must use the keyboard attached.

To start HP PC Hardware Diagnostics (UEFI), follow these steps:

1. Turn on or restart the computer, and quickly press **esc**.
2. Press **f2**.

The BIOS searches three places for the diagnostic tools, in the following order:

- a. Connected USB drive

 **NOTE:** To download the HP PC Hardware Diagnostics (UEFI) tool to a USB drive, see [Downloading HP PC Hardware Diagnostics \(UEFI\) to a USB device on page 99](#).

- b. Hard drive
 - c. BIOS
3. When the diagnostic tool opens, select the type of diagnostic test you want to run, and then follow the on-screen instructions.

 **NOTE:** If you need to stop a diagnostic test, press **esc**.

Downloading HP PC Hardware Diagnostics (UEFI) to a USB device

 **NOTE:** The HP PC Hardware Diagnostics (UEFI) download instructions are provided in English only, and you must use a Windows computer to download and create the HP UEFI support environment because only .exe files are offered.

There are two options to download HP PC Hardware Diagnostics to a USB device.

Download the latest UEFI version

1. Go to <http://www.hp.com/go/techcenter/pcdiags>. The HP PC Diagnostics home page is displayed.
2. In the HP PC Hardware Diagnostics section, select the **Download** link, and then select **Run**.

Download any version of UEFI for a specific product

1. Go to <http://www.hp.com/support>.
2. Select **Get software and drivers**.
3. Enter the product name or number.

4. Select your computer, and then select your operating system.
5. In the **Diagnostic** section, follow the on-screen instructions to select and download the UEFI version you want.

Using Remote HP PC Hardware Diagnostics (UEFI) settings (select products only)

Your computer supports Remote HP PC Hardware Diagnostics (UEFI). This is a firmware (BIOS) feature that downloads HP PC Hardware Diagnostics UEFI to your computer.

It executes the diagnostics on your computer, and then may upload results to a preconfigured server.

Using the Remote HP PC Hardware Diagnostics setting in Computer Setup (BIOS), you can perform the following customizations:

- Set a schedule for running diagnostics unattended. You can also start diagnostics immediately in interactive mode by selecting **Execute Remote HP PC Hardware Diagnostics**.
- Set the location for downloading the diagnostic tools. This feature provides access to the tools from the HP website or from a server that has been preconfigured for use. Your computer does not require the traditional local storage (such as a disk drive or USB flash drive) to run remote diagnostics.
- Set a location for storing the test results. You can also set the user name and password settings used for uploads.
- Display status information about the diagnostics run previously.

Customizing Remote HP PC Hardware Diagnostics (UEFI) settings

1. Turn on or restart the computer, and when the HP logo appears, press **F10** to enter Computer Setup.
2. Select **Advanced**, and then select **Settings**.
3. Make your customization selections.
4. Select **Main**, and then **Save Changes and Exit** to save your settings.

Your changes take effect when the computer restarts.

To access documentation on using Remote HP PC Hardware Diagnostics (UEFI) to configure a server for remote diagnostics or to customize which diagnostic tests are run, go to <http://www.hp.com/support>. Select **Find your product**, and then follow the on-screen instructions.

12 Troubleshooting without diagnostics

This chapter provides information on how to identify and correct minor problems, such as USB devices, hard drive, optical drive, graphics, audio, memory, and software problems. If you encounter problems with the computer, refer to the tables in this chapter for probable causes and recommended solutions.

 **NOTE:** For information on specific error messages that may appear on the screen during Power-On Self-Test (POST) at startup, refer to [POST error messages and diagnostic front panel LEDs and audible codes on page 88](#).

Safety and comfort

 **WARNING!** Misuse of the computer or failure to establish a safe and comfortable work environment may result in discomfort or serious injury. Refer to the *Safety & Comfort Guide* at <http://www.hp.com/ergo> for more information on choosing a workspace and creating a safe and comfortable work environment. For more information, refer to the *Safety & Regulatory Information* guide.

Before you call for technical support

 **IMPORTANT:** Always be sure to load the latest BIOS and drivers, available from <http://support.hp.com/>.

If you are having problems with the computer, try the appropriate solutions below to try to isolate the exact problem before calling for technical support.

- Run the HP diagnostic tool.
- Run the hard drive self-test in Computer Setup. Refer to [Computer Setup \(F10\) Utility on page 77](#) for more information.
- Check the Power LED on the front of the computer to see if it is flashing red. The flashing lights are error codes that will help you diagnose the problem. Refer to [POST error messages and diagnostic front panel LEDs and audible codes on page 88](#) for more information.
- If the screen is blank, plug the monitor into a different video port on the computer if one is available. Or, replace the monitor with a monitor that you know is functioning properly.
- If you are working on a network, plug another computer with a different cable into the network connection. There may be a problem with the network plug or cable.
- If you recently added new hardware, remove the hardware and see if the computer functions properly.
- If you recently installed new software, uninstall the software and see if the computer functions properly.
- Boot the computer to the Safe Mode to see if it will boot without all of the drivers loaded. When booting the operating system, use “Last Known Configuration.”
- Refer to the comprehensive online technical support at <http://www.hp.com/support>.
- Refer to [Helpful hints on page 102](#) in this guide.

To assist you in resolving problems online, HP Instant Support Professional Edition provides you with self-solve diagnostics. If you need to contact HP support, use HP Instant Support Professional Edition's online chat feature. Access HP Instant Support Professional Edition at: <http://www.hp.com/go/ispe>.

Access the Business Support Center (BSC) at <http://www.hp.com/go/bizsupport> for the latest online support information, software and drivers, proactive notification, and worldwide community of peers and HP experts.

If it becomes necessary to call for technical assistance, be prepared to do the following to ensure that your service call is handled properly:

- Be in front of your computer when you call.
- Write down the computer serial number, product ID number, and monitor serial number before calling.
- Spend time troubleshooting the problem with the service technician.
- Remove any hardware that was recently added to your system.
- Remove any software that was recently installed.
- Restore the system from the Recovery Disc Set that you created or restore the system to its original factory condition in System Software Requirement Disks (SSRD).

 **CAUTION:** Restoring the system will erase all data on the hard drive. Be sure to back up all data files before running the restore process.

 **NOTE:** For sales information and warranty upgrades (Care Packs), call your local authorized service provider or dealer.

Helpful hints

 **IMPORTANT:** Always be sure to load the latest BIOS and drivers, available from <http://support.hp.com/>.

If you encounter problems with the computer, monitor, or software, see the following list of general suggestions before taking further action:

- Check that the computer and monitor are plugged into a working electrical outlet.
- Check that the voltage select switch (some models) is set to the appropriate voltage for your region (115V or 230V).
- Check that the computer is turned on and the white power light is on.
- Check that the monitor is turned on and the green monitor light is on.
- Check the Power LED on the front of the computer to see if it is flashing red. The flashing lights are error codes that will help you diagnose the problem. Refer to [POST error messages and diagnostic front panel LEDs and audible codes on page 88](#) for more information.
- Turn up the brightness and contrast controls of the monitor if the monitor is dim.
- Press and hold any key. If the system beeps, then the keyboard should be operating correctly.
- Check all cable connections for loose connections or incorrect connections.
- Wake the computer by pressing any key on the keyboard or pressing the power button. If the system remains in suspend mode, shut down the computer by pressing and holding the power button for at least four seconds then press the power button again to restart the computer. If the system will not shut down, unplug the power cord, wait a few seconds, then plug it in again. The computer will restart if it is set to power on automatically as soon as power is restored in Computer Setup. If it does not restart, press the power button to start the computer.
- Reconfigure the computer after installing a non-plug and play expansion board or other option. See [Solving hardware installation problems on page 109](#) for instructions.

- Be sure that all the needed device drivers have been installed. For example, if you are using a printer, you need a driver for that model printer.
- Remove all bootable media (CD/DVD or USB device) from the system before turning it on.
- If you have installed an operating system other than the factory-installed operating system, check to be sure that it is supported on the system.
- If the system has multiple video sources (embedded, PCI, or PCI-Express adapters) installed (embedded video on some models only) and a single monitor, the monitor must be plugged into the monitor connector on the source selected as the primary VGA adapter. During boot, the other monitor connectors are disabled and if the monitor is connected into these ports, the monitor will not function. You can select which source will be the default VGA source in Computer Setup.

 **CAUTION:** When the computer is plugged into an AC power source, there is always voltage applied to the system board. You must disconnect the power cord from the power source before opening the computer to prevent system board or component damage.

Solving retail system-specific problems

The issues listed in this section are specific to features available in this retail system.

 **IMPORTANT:** Always be sure to load the latest BIOS and drivers, available from <http://support.hp.com/>.

Powered serial ports do not have power.

Cause	Solution
Ports are not correctly configured. The serial ports can be configured as standard (non-powered) serial ports or powered serial ports.	To change the voltage settings for a powered serial port: <ol style="list-style-type: none"> 1. Remove the bottom plate from the I/O connectivity base. 2. Adjust the voltage select switch behind each serial port to the desired setting. Available settings are: <ul style="list-style-type: none"> – 0 volts – 5 volts – 12 volts 3. Replace the bottom plate on the I/O connectivity base. For more information, see Configuring the I/O connectivity base's powered serial ports on page 22.
A powered serial device was connected while system power	The computer must be powered off when you plug in powered serial devices. Disconnect the device, power off the system, plug in the device, and power on the system.

Fingerprint reader does not work.

Cause	Solution
The fingerprint reader only works when installed in the orientation it was registered in.	If the position of the fingerprint reader has been changed, you must re-register the fingerprint reader.

Serial Port Devices do not function after hot swapping. Hot swapping is when connecting or disconnecting a serial device while the system is powered on.

Cause	Solution
RPOS platform serial ports do not support hot swapping.	To ensure that serial device drivers load and to avoid hardware damage, power the system off before connecting or disconnecting serial devices. Hot plugging serial devices is not supported and doing so can cause permanent hardware damage and void warranty.

The magnetic strip reader (MSR) beeps or blinks in an unusual way or card data is incomplete or garbled.

Cause	Solution
The MSR may be improperly configured or has become defective.	Try cleaning the MSR. Swipe a standard cleaning card through the MSR a couple of times to clean the MSR. You can order a standard cleaning card online. Alternately, you can create a cleaning card by putting a thin, oil free cloth around a credit card.

A new MSR does not work.

Cause	Solution
The new MSR needs to be configured with the system settings using HP USB Mini Magnetic Stripe Reader (MSR) Configuration Software.	<ol style="list-style-type: none">1. Connect the old MSR (the one being replaced).2. Start HP magnetic stripe reader configuration utility (http://h20564.www2.hp.com/hpsc/swd/public/detail?swItemId=ir_125989_1&swEnvOid=4047).3. Retrieve the configuration details from the old MSR and save.4. Connect the new MSR (the replacement).5. Write the saved configuration to the new MSR.

Solving general problems

You may be able to easily resolve the general problems described in this section. If a problem persists and you are unable to resolve it yourself or if you feel uncomfortable about performing the operation, contact an authorized dealer or reseller.

 **WARNING!** When the computer is plugged into an AC power source, voltage is always applied to the system board. To reduce the risk of personal injury from electrical shock and/or hot surfaces, be sure to disconnect the power cord from the wall outlet and allow the internal system components to cool before touching.

Cannot access the Computer Setup (F10) Utility when booting the computer.

Cause	Solution
The Computer Setup (F10) Utility is set to “fast boot” causing the F10 access screen to display too briefly when booting the computer.	Before turning on the computer, press and hold F10 . Turn on the computer and continue to hold F10 until the Computer Setup (F10) Utility is displayed. - or -

Cannot access the Computer Setup (F10) Utility when booting the computer.

Cause	Solution
	Follow the Windows instructions for rebooting the computer into the Computer Setup (F10) Utility.

Computer appears locked up and will not turn off when the power button is pressed.

Cause	Solution
Software control of the power switch is not functional.	<ol style="list-style-type: none">1. Press and hold the power button for at least four seconds until the computer turns off.2. Disconnect the power cord from the electrical outlet.

Computer will not respond to keyboard or mouse.

Cause	Solution
Computer is in Sleep state.	To resume from Sleep state, press the power button. CAUTION: When attempting to resume from Sleep state, do not hold down the power button for more than four seconds. Otherwise, the computer will shut down and you will lose any unsaved data.
System has locked up.	Restart computer.

Computer date and time display is incorrect.

Cause	Solution
RTC (real-time clock) battery may need to be replaced. NOTE: Connecting the computer to a live AC outlet prolongs the life of the RTC battery.	Reset the date and time under Control Panel (Computer Setup can also be used to update the RTC date and time). If the problem persists, replace the RTC battery. See the Removal and Replacement section for instructions on installing a new battery, or contact an authorized dealer or reseller for RTC battery replacement. To access Control Panel in Windows 10, type <code>control panel</code> in the taskbar search box, and then select Control Panel.

There is no sound or sound volume is too low.

Cause	Solution
System volume may be set low or muted.	<ol style="list-style-type: none">1. Check the Computer Setup settings to make sure the internal system speaker is not muted (this setting does not affect the external speakers).2. Make sure the external speakers are properly connected and powered on and that the speakers' volume control is set correctly.

There is no sound or sound volume is too low.

Cause	Solution
	<ol style="list-style-type: none">3. Use the system volume control available in the operating system to make sure the speakers are not muted or to increase the volume.

Cannot remove computer cover or access panel.

Cause	Solution
Smart Cover Lock, featured on some computers, is locked.	Unlock the Smart Cover Lock using Computer Setup. In case of forgotten password, power loss, or computer malfunction, you must manually disable the Smart Cover lock . A key to unlock the Smart Cover Lock is not available from HP. Keys are typically available from a hardware store.

Poor performance.

Cause	Solution
Processor is too hot.	<ol style="list-style-type: none">1. Make sure airflow to the computer is not blocked. Leave a 10.2-cm (4-inch) clearance on all vented sides of the computer and above the monitor to permit the required airflow.2. Make sure fans are connected and working properly (some fans only operate when needed).3. Make sure the processor heat sink is installed properly.
Hard drive is full.	Transfer data from the hard drive to create more space on the hard drive.
Low on memory.	Add more memory.
Hard drive fragmented.	Defragment hard drive.
Program previously accessed did not release reserved memory back to the system.	Restart the computer.
Virus resident on the hard drive.	Run virus protection program.
Too many applications running.	<ol style="list-style-type: none">1. Close unnecessary applications to free up memory.2. Add more memory.3. Some applications run in the background and can be closed by right-clicking on their corresponding icons in the task tray. To prevent these applications from launching at startup: In Windows 10:<ol style="list-style-type: none">a. Type <code>msconfig</code> in the taskbar search box, and then select msconfig.b. On the Startup tab of the System Configuration Utility, click Open Task Manager.c. Select applications that you do not want to launch automatically, and the click Disable.

Poor performance.

Cause	Solution
Some software applications, especially games, are stressful on the graphics subsystem.	<ol style="list-style-type: none">1. Lower the display resolution for the current application or consult the documentation that came with the application for suggestions on how to improve performance by adjusting parameters in the application.2. Add more memory.3. Upgrade the graphics solution.
Cause unknown.	Restart the computer.

Computer powered off automatically and the Power LED flashes red four times and then white two times.

Cause	Solution
Processor thermal protection activated: A fan may be blocked or not turning. OR The heat sink is not properly attached to the processor.	<ol style="list-style-type: none">1. Ensure that the computer air vents are not blocked and the processor cooling fan is running.2. Open the access panel, press the power button, and see if the processor fan (or other system fan) spins. If the fan does not spin, make sure the fan cable is plugged onto the system board header.3. If fan a plugged in and not spinning, replace it.

System does not power on and the LEDs on the front of the computer are not flashing.

Cause	Solution
System unable to power on.	<p>Press and hold the power button for less than 4 seconds. If the hard drive LED turns white, then:</p> <ol style="list-style-type: none">1. If equipped with a voltage selector, check that the voltage selector (located on the rear of the power supply) is set to the appropriate voltage. Proper voltage setting depends on your region.2. Remove the expansion cards one at a time until the 5V_aux light on the system board turns on.3. Replace the system board. <p>OR</p> <p>Press and hold the power button for less than 4 seconds. If the hard drive LED does not turn on white then:</p> <ol style="list-style-type: none">1. Check that the unit is plugged into a working AC outlet.2. Open the access panel and check that the power button cable is properly connected to the system board.3. Check that the power supply cables are properly connected to the system board.4. Check to see if the 5V_aux light on the system board is turned on. If it is turned on, then replace the power button assembly.

System does not power on and the LEDs on the front of the computer are not flashing.

Cause	Solution
	<ol style="list-style-type: none">5. If the 5V_aux light on the system board is off, then replace the power supply.6. Replace the system board.

Solving printer problems

If you encounter printer problems, see the documentation that came with the printer and to the common causes and solutions listed in the following table.

Printer will not print.

Cause	Solution
Printer is not turned on and online.	Turn the printer on and make sure it is online.
The correct printer drivers for the application are not installed.	<ol style="list-style-type: none">1. Install the correct printer driver for the application.2. Try printing using the MS-DOS command: <pre>DIR C:\ > [printer port]</pre>where [printer port] is the address of the printer being used. If the printer works, reload the printer driver. To run MS-DOS commands, press the Windows key + r, type cmd in the Open box, and then click OK.
If you are on a network, you may not have made the connection to the printer.	Make the proper network connections to the printer.
Printer may have failed.	Run printer self-test.

Printer will not turn on.

Cause	Solution
The cables may not be connected properly.	Reconnect all cables and check the power cord and electrical outlet.

Printer prints garbled information.

Cause	Solution
The correct printer driver for the application is not installed.	Install the correct printer driver for the application.
The cables may not be connected properly.	Reconnect all cables.
Printer memory may be overloaded.	Reset the printer by turning it off for one minute, then turn it back on.

Printer will not print.

Cause	Solution
The printer may be out of paper.	Check the paper tray and refill it if it is empty.

Solving hardware installation problems

You may need to reconfigure the computer when you add or remove hardware, such as an additional drive or expansion card. If you install a plug and play device, Windows automatically recognizes the device and configures the computer. If you install a non-plug and play device, you must reconfigure the computer after completing installation of the new hardware. In Windows, use the **Add Hardware Wizard** and follow the instructions that appear on the screen.

To open the Add Hardware Wizard, open a Command Prompt and open `hdwwiz.exe`.

 **WARNING!** When the computer is plugged into an AC power source, voltage is always applied to the system board. To reduce the risk of personal injury from electrical shock and/or hot surfaces, be sure to disconnect the power cord from the wall outlet and allow the internal system components to cool before touching.

A new device is not recognized as part of the system.

Cause	Solution
Device is not seated or connected properly.	Ensure that the device is properly and securely connected and that pins in the connector are not bent down.
Cable(s) of new external device are loose or power cables are unplugged.	Ensure that all cables are properly and securely connected and that pins in the cable or connector are not bent down.
Power switch of new external device is not turned on.	Turn off the computer, turn on the external device, then turn on the computer to integrate the device with the computer system.
When the system advised you of changes to the configuration, you did not accept them.	Reboot the computer and follow the instructions for accepting the changes.
A plug and play board may not automatically configure when added if the default configuration conflicts with other devices.	Use Windows Device Manager to deselect the automatic settings for the board and choose a basic configuration that does not cause a resource conflict. You can also use Computer Setup to reconfigure or disable devices to resolve the resource conflict. To access Device Manager in Windows 10, type <code>device manager</code> in the taskbar search box, and then select Device Manager from the list of applications.
USB ports on the computer are disabled in Computer Setup.	Run the Computer Setup utility and ensure that Device available is selected for appropriate USB ports under Advanced > Port Options .

Computer will not start.

Cause	Solution
Wrong memory modules were used in the upgrade or memory modules were installed in the wrong location.	<ol style="list-style-type: none">1. Review the documentation that came with the system to determine if you are using the correct memory modules and to verify the proper installation. NOTE: DIMM1 or XMM1 must always be installed. DIMM1 must be installed before DIMM3.

Computer will not start.

Cause	Solution
	<ol style="list-style-type: none">2. Observe the beeps and LED lights on the front of the computer. Beeps and flashing LEDs are codes for specific problems.3. If you still cannot resolve the issue, contact Customer Support.

Power LED flashes Red three times and then white two times.

Cause	Solution
Memory is installed incorrectly or is bad.	<p>CAUTION: To avoid damage to the DIMMs or the system board, you must unplug the computer power cord before attempting to reseal, install, or remove a DIMM module.</p> <ol style="list-style-type: none">1. Reseat DIMMs. Power on the system.2. Replace DIMMs one at a time to isolate the faulty module. <p>NOTE: DIMM1 or XMM1 must always be installed. DIMM1 must be installed before DIMM3.</p> <ol style="list-style-type: none">3. Replace third-party memory with HP memory.4. Replace the system board.

Solving network problems

Some common causes and solutions for network problems are listed in the following table. These guidelines do not discuss the process of debugging the network cabling.

Network driver does not detect network controller.

Cause	Solution
Network controller is disabled.	<ol style="list-style-type: none">1. Run Computer Setup and enable network controller.2. Enable the network controller in the operating system using Device Manager. <p>To access Device Manager in Windows 10, type <code>device manager</code> in the taskbar search box, and then select Device Manager from the list of applications.</p>
Incorrect network driver.	Check the network controller documentation for the correct driver or obtain the latest driver from the manufacturer's Web site.

Network status link light never flashes.

NOTE: The network status light is supposed to flash when there is network activity.

Cause	Solution
No active network is detected.	Check cabling and network equipment for proper connection.

Network status link light never flashes.

NOTE: The network status light is supposed to flash when there is network activity.

Cause	Solution
Network controller is not set up properly.	Check for the device status within Windows, such as Device Manager for driver load and the Network Connections applet within Windows for link status. To access Device Manager in Windows 10, type <code>device manager</code> in the taskbar search box, and then select Device Manager from the list of applications.
Network controller is disabled.	<ol style="list-style-type: none">1. Run Computer Setup and enable network controller.2. Enable the network controller in the operating system using Device Manager. To access Device Manager in Windows 10, type <code>device manager</code> in the taskbar search box, and then select Device Manager from the list of applications.
Network driver is not properly loaded.	Reinstall network drivers.
System cannot autosense the network.	Disable auto-sensing capabilities and force the system into the correct operating mode.

Diagnostics reports a failure.

Cause	Solution
The cable is not securely connected.	Ensure that the cable is securely attached to the network connector and that the other end of the cable is securely attached to the correct device.
The cable is attached to the incorrect connector.	Ensure that the cable is attached to the correct connector.
There is a problem with the cable or a device at the other end of the cable.	Ensure that the cable and device at the other end are operating correctly.
The network controller is defective.	Contact an authorized service provider.

Diagnostics passes, but the computer does not communicate with the network.

Cause	Solution
Network drivers are not loaded, or driver parameters do not match current configuration.	Make sure the network drivers are loaded and that the driver parameters match the configuration of the network controller. Make sure the correct network client and protocol is installed.
The network controller is not configured for this computer.	Select the Network and Sharing Center icon in the Control Panel and configure the network controller. To access Control Panel in Windows 10, type <code>control panel</code> in the taskbar search box, and then select Control Panel from the list of applications.

Network controller stopped working when an expansion board was added to the computer.

Cause	Solution
The network controller requires drivers.	Verify that the drivers were not accidentally deleted when the drivers for a new expansion board were installed.

Network controller stops working without apparent cause.

Cause	Solution
The cable is not securely connected.	Ensure that the cable is securely attached to the network connector and that the other end of the cable is securely attached to the correct device.
The network controller is defective.	Contact an authorized service provider.

New network card will not boot.

Cause	Solution
New network card may be defective or may not meet industry-standard specifications.	Install a working, industry-standard NIC, or change the boot sequence to boot from another source.

Cannot connect to network server when attempting Remote System Installation.

Cause	Solution
The network controller is not configured properly.	Verify Network Connectivity, that a DHCP Server is present, and that the Remote System Installation Server contains the NIC drivers for your NIC.

System setup utility reports unprogrammed EEPROM.

Cause	Solution
Unprogrammed EEPROM.	Contact an authorized service provider.

Solving memory problems

If you encounter memory problems, some common causes and solutions are listed in the following table.

⚠ CAUTION: Power may still be supplied to the DIMMs when the computer is turned off (depending on the Management Engine (ME) settings). To avoid damage to the DIMMs or the system board, you must unplug the computer power cord before attempting to reseat, install, or remove a memory module.

For those systems that support ECC memory, HP does not support mixing ECC and non-ECC memory. Otherwise, the computer will not boot the operating system.



NOTE: The memory count will be affected by configurations with the Management Engine (ME) enabled. The ME uses 8MB of system memory in single channel mode or 16MB of memory in dual-channel mode to download, decompress, and execute the ME firmware for Out-of-Band (OOB), third-party data storage, and other management functions.

System will not boot or does not function properly after installing additional memory modules.

Cause	Solution
A memory module is not installed in the DIMM1 or XMM1 socket.	Ensure that a memory module is installed in the DIMM1 or XMM1 socket on the system board. This socket must be populated with a memory module.
Memory module is not the correct type or speed grade for the system or the new memory module is not seated properly.	Replace module with the correct industry-standard device for the computer. On some models, ECC and non-ECC memory modules cannot be mixed.

Out of memory error.

Cause	Solution
You have run out of memory to run the application.	Check the application documentation to determine the memory requirements.

Memory count during POST is wrong.

Cause	Solution
The memory modules may not be installed correctly.	Check that the memory modules have been installed correctly and that proper modules are used.
Integrated graphics may use system memory.	No action required.

Insufficient memory error during operation.

Cause	Solution
Too many Terminate and Stay Resident programs (TSRs) are installed.	Delete any TSRs that you do not need.
You have run out of memory for the application.	Check the memory requirements for the application or add more memory to the computer.

Power LED flashes Red five times, once every second, followed by a two second pause, and the computer beeps five times. (Beeps stop after fifth iteration but LEDs continue flashing.)

Cause	Solution
Memory is installed incorrectly or is bad.	<ol style="list-style-type: none">1. Reseat DIMMs. Power on the system.2. Replace DIMMs one at a time to isolate the faulty module.3. Replace third-party memory with HP memory.4. Replace the system board.

Solving USB flash drive problems

If you encounter USB flash drive problems, common causes and solutions are listed in the following table.

USB flash drive is not seen as a drive letter in Windows.

Cause	Solution
The drive letter after the last physical drive is not available.	Change the default drive letter for the flash drive in Windows.

USB flash drive not found (identified).

Cause	Solution
The device is attached to a USB port that has been hidden in Computer Setup.	Run the Computer Setup utility and enable USB ports in Advanced > Port Options .
The device was not properly seated before power-up.	Ensure the device is fully inserted into the USB port before applying power to the system

System will not boot from USB flash drive.

Cause	Solution
Boot order is not correct.	Run the Computer Setup utility and change boot sequence in Advanced > Boot Options .
Removable Media Boot is disabled in the Computer Setup utility.	Run the Computer Setup utility and enable booting to removable media in Advanced > Boot Options . Ensure USB is enabled in Storage > Boot Order .

The computer boots to DOS after making a bootable flash drive.

Cause	Solution
Flash drive is bootable.	Install the flash drive only after the operating system boots.
Flash drive is defective.	Try a different flash drive.

Solving Internet access problems

If you encounter Internet access problems, consult your Internet Service Provider (ISP) or refer to the common causes and solutions listed in the following table.

Unable to connect to the Internet.

Cause	Solution
Internet Service Provider (ISP) account is not set up properly.	Verify Internet settings or contact your ISP for assistance.
Web browser is not set up properly.	Verify that the Web browser is installed and set up to work with your ISP.
Cable/DSL modem is not plugged in.	Plug in cable/DSL modem. You should see a "power" LED light on the front of the cable/DSL modem.

Unable to connect to the Internet.

Cause	Solution
Cable/DSL service is not available or has been interrupted due to bad weather.	Try connecting to the Internet at a later time or contact your ISP. (If the cable/DSL service is connected, the “cable” LED light on the front of the cable/DSL modem will be on.)
The CAT5 UTP cable is disconnected.	Connect the CAT5 UTP cable between the cable modem and the computer’s RJ-45 connector. (If the connection is good, the “PC” LED light on the front of the cable/DSL modem will be on.)
IP address is not configured properly.	Contact your ISP for the correct IP address.
Cookies are corrupted. (A “cookie” is a small piece of information that a Web server can store temporarily with the Web browser. This is useful for having the browser remember some specific information that the Web server can later retrieve.)	Windows 10: <ol style="list-style-type: none">1. Type <code>control panel</code> in the taskbar search box, and then select Control Panel from the list of applications.2. Click Internet Options.3. In the Browsing history section, click the Delete button.4. Select the Cookies and website data check box and click the Delete button.

Cannot automatically launch Internet programs.

Cause	Solution
You must log on to your ISP before some programs will start.	Log on to your ISP and launch the desired program.

Solving software problems

Most software problems occur as a result of the following:

- The application was not installed or configured correctly.
- There is insufficient memory available to run the application.
- There is a conflict between applications.
- Be sure that all the needed device drivers have been installed.
- If you have installed an operating system other than the factory-installed operating system, check to be sure it is supported on the system.

If you encounter software problems, see the applicable solutions listed in the following table.

Computer will not continue and the HP logo does not display.

Cause	Solution
ROM issue - POST error has occurred.	Observe the beeps and LED lights on the front of the computer. See POST error messages and diagnostic front panel LEDs and audible codes on page 88 to determine possible causes. See the Worldwide Limited Warranty for terms and conditions.

“Illegal Operation has Occurred” error message is displayed.

Cause	Solution
Software being used is not Microsoft-certified for your version of Windows.	Verify that the software is certified by Microsoft for your version of Windows (see program packaging for this information).
Configuration files are corrupt.	If possible, save all data, close all programs, and restart the computer.

13 System backup and recovery

Backing up, restoring, and recovering in Windows 10

This section provides information about the following processes. The information in the section is standard procedure for most products.

- Creating recovery media and backups
- Restoring and recovering your system

For additional information, refer to Help and Support.

- ▲ Type `help` in the taskbar search box, and then select **Help and Support**.

Creating recovery media and backups

The following methods of creating recovery media and backups are available on select products only. Choose the available method according to your computer model.

- Use HP Recovery Manager to create HP Recovery media after you successfully set up the computer. This step creates a backup of the HP Recovery partition on the computer. The backup can be used to reinstall the original operating system in cases where the hard drive is corrupted or has been replaced. For information on creating recovery media, see [Creating HP Recovery media \(select products only\) on page 117](#). For information on the recovery options that are available using the recovery media, see [What you need to know before you get started on page 119](#).
- Use Windows tools to create system restore points and create backups of personal information. For more information, see [Using Windows tools on page 119](#).



NOTE: If storage is 32 GB or less, Microsoft System Restore is disabled by default.

Creating HP Recovery media (select products only)

If possible, check for the presence of the Recovery partition and the Windows partition. From the Start menu, select **File Explorer**.

- If your computer does not list the Windows partition and the Recovery partition, you can obtain recovery media for your system from support. See the *Worldwide Telephone Numbers* booklet included with the computer. You can also find contact information on the HP website. Go to <http://www.hp.com/support>, select your country or region, and follow the on-screen instructions.

You can use Windows tools to create system restore points and create backups of personal information, see [Using Windows tools on page 119](#).

- If your computer does list the Recovery partition and the Windows partition, you can use HP Recovery Manager to create recovery media after you successfully set up the computer. HP Recovery media can be used to perform system recovery if the hard drive becomes corrupted. System recovery reinstalls the original operating system and software programs that were installed at the factory and then configures the settings for the programs. HP Recovery media can also be used to customize the system or restore the factory image if you replace the hard drive.

- Only one set of recovery media can be created. Handle these recovery tools carefully, and keep them in a safe place.
- HP Recovery Manager examines the computer and determines the required storage capacity for the media that will be required.
- To create recovery discs, your computer must have an optical drive with DVD writer capability, and you must use only high-quality blank DVD-R, DVD+R, DVD-R DL, or DVD+R DL discs. Do not use rewritable discs such as CD±RW, DVD±RW, double-layer DVD±RW, or BD-RE (rewritable Blu-ray) discs; they are not compatible with HP Recovery Manager software. Or, instead, you can use a high-quality blank USB flash drive.
- If your computer does not include an integrated optical drive with DVD writer capability, but you would like to create DVD recovery media, you can use an external optical drive (purchased separately) to create recovery discs. If you use an external optical drive, it must be connected directly to a USB port on the computer; the drive cannot be connected to a USB port on an external device, such as a USB hub. If you cannot create DVD media yourself, you can obtain recovery discs for your computer from HP. See the *Worldwide Telephone Numbers* booklet included with the computer. You can also find contact information on the HP website. Go to <http://www.hp.com/support>, select your country or region, and follow the on-screen instructions.
- Be sure that the computer is connected to AC power before you begin creating the recovery media.
- The creation process can take an hour or more. Do not interrupt the creation process.
- If necessary, you can exit the program before you have finished creating all of the recovery DVDs. HP Recovery Manager will finish burning the current DVD. The next time you start HP Recovery Manager, you will be prompted to continue.

To create HP Recovery media:

1. Type `recovery` in the taskbar search box, and then select **HP Recovery Manager**.
2. Select **Create recovery media**, and then follow the on-screen instructions.

If you ever need to recover the system, see [Recovering using HP Recovery Manager on page 119](#).

Using Windows tools

You can create recovery media, system restore points, and backups of personal information using Windows tools.

 **NOTE:** If storage is 32 GB or less, Microsoft System Restore is disabled by default.

For more information and steps, see Help and Support.

- ▲ Type `help` in the taskbar search box, and then select Help and Support.

Restore and recovery

There are several options for recovering your system. Choose the method that best matches your situation and level of expertise:

 **IMPORTANT:** Not all methods are available on all products.

- Windows offers several options for restoring from backup, refreshing the computer, and resetting the computer to its original state. For more information see Help and Support.
 - ▲ Type `help` in the taskbar search box, and then select **Help and Support**.
- If you need to correct a problem with a preinstalled application or driver, use the Reinstall drivers and/or applications option (select products only) of HP Recovery Manager to reinstall the individual application or driver.
 - ▲ Type `recovery` in the taskbar search box, select **HP Recovery Manager**, select **Reinstall drivers and/or applications**, and then follow the on-screen instructions.
- If you want to recover the Windows partition to original factory content, you can choose the System Recovery option from the HP Recovery partition (select products only) or use the HP Recovery media. For more information, see [Recovering using HP Recovery Manager on page 119](#). If you have not already created recovery media, see [Creating HP Recovery media \(select products only\) on page 117](#).
- On select products, if you want to recover the computer's original factory partition and content, or if you have replaced the hard drive, you can use the Factory Reset option of HP Recovery media. For more information, see [Recovering using HP Recovery Manager on page 119](#).
- On select products, if you want to remove the recovery partition to reclaim hard drive space, HP Recovery Manager offers the Remove Recovery Partition option.

For more information, see [Removing the HP Recovery partition \(select products only\) on page 121](#).

Recovering using HP Recovery Manager

HP Recovery Manager software allows you to recover the computer to its original factory state by using the HP Recovery media that you either created or that you obtained from HP, or by using the HP Recovery partition (select products only). If you have not already created recovery media, see [Creating HP Recovery media \(select products only\) on page 117](#).

What you need to know before you get started

- HP Recovery Manager recovers only software that was installed at the factory. For software not provided with this computer, you must either download the software from the manufacturer's website or reinstall the software from the media provided by the manufacturer.

 **IMPORTANT:** Recovery through HP Recovery Manager should be used as a final attempt to correct computer issues.

- HP Recovery media must be used if the computer hard drive fails. If you have not already created recovery media, see [Creating HP Recovery media \(select products only\) on page 117](#).
- To use the Factory Reset option (select products only), you must use HP Recovery media. If you have not already created recovery media, see [Creating HP Recovery media \(select products only\) on page 117](#).
- If your computer does not allow the creation of HP Recovery media or if the HP Recovery media does not work, you can obtain recovery media for your system from support. See the *Worldwide Telephone Numbers* booklet included with the computer. You can also find contact information from the HP website. Go to <http://www.hp.com/support>, select your country or region, and follow the on-screen instructions.

 **IMPORTANT:** HP Recovery Manager does not automatically provide backups of your personal data. Before beginning recovery, back up any personal data you want to retain.

Using HP Recovery media, you can choose from one of the following recovery options:

 **NOTE:** Only the options available for your computer display when you start the recovery process.

- System Recovery—Reinstalls the original operating system, and then configures the settings for the programs that were installed at the factory.
- Factory Reset—Restores the computer to its original factory state by deleting all information from the hard drive and re-creating the partitions. Then it reinstalls the operating system and the software that was installed at the factory.

The HP Recovery partition (select products only) allows System Recovery only.

Using the HP Recovery partition (select products only)

The HP Recovery partition allows you to perform a system recovery without the need for recovery discs or a recovery USB flash drive. This type of recovery can be used only if the hard drive is still working.

To start HP Recovery Manager from the HP Recovery partition:

1. Type `recovery` in the taskbar search box, select **Recovery Manager**, and then select **HP Recovery Environment**.

- or -

Press **f11** while the computer boots, or press and hold **f11** as you press the power button.

2. Select **Troubleshoot** from the boot options menu.
3. Select **Recovery Manager**, and then follow the on-screen instructions.

Using HP Recovery media to recover

You can use HP Recovery media to recover the original system. This method can be used if your system does not have an HP Recovery partition or if the hard drive is not working properly.

1. If possible, back up all personal files.
2. Insert the HP Recovery media, and then restart the computer.

 **NOTE:** If the computer does not automatically restart in HP Recovery Manager, change the computer boot order. See [Changing the computer boot order on page 121](#).

3. Follow the on-screen instructions.

Changing the computer boot order

If your computer does not restart in HP Recovery Manager, you can change the computer boot order, which is the order of devices listed in BIOS where the computer looks for startup information. You can change the selection to an optical drive or a USB flash drive.

To change the boot order:

1. Insert the HP Recovery media.
2. Access BIOS.
Restart the computer, quickly press **esc**, and then press **f9** for boot options.
3. Select the optical drive or USB flash drive from which you want to boot.
4. Follow the on-screen instructions.

Removing the HP Recovery partition (select products only)

HP Recovery Manager software allows you to remove the HP Recovery partition to free up hard drive space.

 **IMPORTANT:** After you remove the HP Recovery partition, you will not be able to perform System Recovery or create HP recovery media from the HP Recovery partition. So before you remove the Recovery partition, create HP Recovery media; see [Creating HP Recovery media \(select products only\) on page 117](#).

 **NOTE:** The Remove Recovery Partition option is only available on products that support this function.

Follow these steps to remove the HP Recovery partition:

1. Type `recovery` in the taskbar search box, and then select **HP Recovery Manager**.
2. Select **Remove Recovery Partition**, and then follow the on-screen instructions.

A Power cord set requirements

The power supplies on some computers have external power switches. The voltage select switch feature on the computer permits it to operate from any line voltage between 100-120 or 220-240 volts AC. Power supplies on those computers that do not have external power switches are equipped with internal switches that sense the incoming voltage and automatically switch to the proper voltage.

The power cord set received with the computer meets the requirements for use in the country where you purchased the equipment.

Power cord sets for use in other countries must meet the requirements of the country where you use the computer.

General requirements

The requirements listed below are applicable to all countries:

1. The power cord must be approved by an acceptable accredited agency responsible for evaluation in the country where the power cord set will be installed.
2. The power cord set must have a minimum current capacity of 10A (7A Japan only) and a nominal voltage rating of 125 or 250 volts AC, as required by each country's power system.
3. The diameter of the wire must be a minimum of 0.75 mm² or 18AWG, and the length of the cord must be between 1.8 m (6 feet) and 3.6 m (12 feet).

The power cord should be routed so that it is not likely to be walked on or pinched by items placed upon it or against it. Particular attention should be paid to the plug, electrical outlet, and the point where the cord exits from the product.

 **WARNING!** Do not operate this product with a damaged power cord set. If the power cord set is damaged in any manner, replace it immediately.

Japanese power cord requirements

For use in Japan, use only the power cord received with this product.

 **CAUTION:** Do not use the power cord received with this product on any other products.

Country-specific requirements

Additional requirements specific to a country are shown in parentheses and explained below.

Country	Accrediting Agency	Country	Accrediting Agency
Australia (1)	EANSW	Italy (1)	IMQ
Austria (1)	OVE	Japan (3)	METI
Belgium (1)	CEBC	Norway (1)	NEMKO
Canada (2)	CSA	Sweden (1)	SEMKO
Denmark (1)	DEMKO	Switzerland (1)	SEV
Finland (1)	SETI	United Kingdom (1)	BSI
France (1)	UTE	United States (2)	UL
Germany (1)	VDE		

1. The flexible cord must be Type H05VV-F, 3-conductor, 0.75mm² conductor size. Power cord set fittings (appliance coupler and wall plug) must bear the certification mark of the agency responsible for evaluation in the country where it will be used.
2. The flexible cord must be Type SVT or equivalent, No. 18 AWG, 3-conductor. The wall plug must be a two-pole grounding type with a NEMA 5-15P (15A, 125V) or NEMA 6-15P (15A, 250V) configuration.
3. Appliance coupler, flexible cord, and wall plug must bear a "T" mark and registration number in accordance with the Japanese Dentori Law. Flexible cord must be Type VCT or VCTF, 3-conductor, 0.75 mm² conductor size. Wall plug must be a two-pole grounding type with a Japanese Industrial Standard C8303 (7A, 125V) configuration.

B Statement of memory volatility

The purpose of this chapter is to provide general information regarding nonvolatile memory in HP Business computers. This chapter also provides general instructions for restoring nonvolatile memory that can contain personal data after the system has been powered off and the hard drive has been removed.

HP Business computer products that use Intel®-based or AMD®-based system boards contain volatile DDR memory. The amount of nonvolatile memory present in the system depends upon the system configuration. Intel-based and AMD-based system boards contain nonvolatile memory subcomponents as originally shipped from HP, assuming that no subsequent modifications have been made to the system and assuming that no applications, features, or functionality have been added to or installed on the system.

Following system shutdown and removal of all power sources from an HP Business computer system, personal data can remain on volatile system memory (DIMMs) for a finite period of time and will also remain in nonvolatile memory. Use the steps below to remove personal data from the computer, including the nonvolatile memory found in Intel-based and AMD-based system boards.

 **NOTE:** If your tablet has a keyboard base, connect to the keyboard base before beginning steps in this chapter.

Current BIOS steps

1. Follow steps (a) through (l) below to restore the nonvolatile memory that can contain personal data. Restoring or reprogramming nonvolatile memory that does not store personal data is neither necessary nor recommended.
 - a. Turn on or restart the computer, and then press **esc** while the “Press the ESC key for Startup Menu” message is displayed at the bottom of the screen.

 **NOTE:** If the system has a BIOS administrator password, enter the password at the prompt.

- b. Select **Main**, select **Apply Factory Defaults and Exit**, and then select **Yes** to load defaults.
The computer will reboot.
 - c. During the reboot, press **esc** while the “Press the ESC key for Startup Menu” message is displayed at the bottom of the screen.

 **NOTE:** If the system has a BIOS administrator password, enter the password at the prompt.

- d. Select the **Security** menu, select **Restore Security Settings to Factory Defaults**, and then select **Yes** to restore security level defaults.
The computer will reboot.
 - e. During the reboot, press **esc** while the “Press the ESC key for Startup Menu” message is displayed at the bottom of the screen.

 **NOTE:** If the system has a BIOS administrator password, enter the password at the prompt.

- f. If an asset or ownership tag is set, select the **Security** menu and scroll down to the **Utilities** menu. Select **System IDs**, and then select **Asset Tracking Number**. Clear the tag, and then make the selection to return to the prior menu.

Nonvolatile memory usage

Nonvolatile Memory Type	Amount (Size)	Does this memory store customer data?	Does this memory retain data when power is removed?	What is the purpose of this memory?	How is data input into this memory?	How is this memory write-protected?
HP Sure Start flash (select models only)	8 MBytes	No	Yes	Provides protected backup of critical System BIOS code, EC firmware, and critical computer configuration data for select platforms that support HP Sure Start. For more information, see Using HP Sure Start (select models only) on page 129 .	Data cannot be written to this device via the host processor. The content is managed solely by the HP Sure Start Embedded Controller.	This memory is protected by the HP Sure Start Embedded Controller.
Real Time Clock (RTC) battery backed-up CMOS configuration memory	256 Bytes	No	Yes	Stores system date and time and noncritical data.	RTC battery backed-up CMOS is programmed using the Computer Setup (BIOS), or changing the Microsoft Windows date & time.	This memory is not write-protected.
Controller (NIC) EEPROM	64 KBytes (not customer accessible)	No	Yes	Stores NIC configuration and NIC firmware.	NIC EEPROM is programmed using a utility from the NIC vendor that can be run from DOS.	A utility is required to write data to this memory and is available from the NIC vendor. Writing data to this ROM in an inappropriate manner will render the NIC non-functional.
DIMM Serial Presence Detect (SPD) configuration data	256 Bytes per memory module, 128 Bytes programmable (not customer accessible)	No	Yes	Stores memory module information.	DIMM SPD is programmed by the memory vendor.	Data cannot be written to this memory when the module is installed in a computer. The specific write-protection method varies by memory vendor.
System BIOS	9 MBytes	Yes	Yes	Stores system BIOS code and computer configuration data.	System BIOS code is programmed at the factory. Code is updated when the system BIOS is updated. Configuration data and settings are input using the Computer Setup (BIOS) or a custom utility.	NOTE: Writing data to this ROM in an inappropriate manner can render the computer non-functional. A utility is required for writing data to this memory and is available on the HP website; go to http://www.hp.com/support . Select Find your

Nonvolatile Memory Type	Amount (Size)	Does this memory store customer data?	Does this memory retain data when power is removed?	What is the purpose of this memory?	How is data input into this memory?	How is this memory write-protected?
Intel Management Engine Firmware (present only in select Elite or Z models. For more information, go to http://www.hp.com/support . Select Find your product , and then follow the on-screen instructions.)	1.5 MBytes or 7 MBytes	Yes	Yes	Stores Management Engine Code, Settings, Provisioning Data and iAMT third-party data store.	Management Engine Code is programmed at the factory. Code is updated via Intel secure firmware update utility. Unique Provisioning Data can be entered at the factory or by an administrator using the Management Engine (MEBx) setup utility. The third party data store contents can be populated by a remote management console or local applications that have been registered by an administrator to have access to the space.	product , and then follow the on-screen instructions. The Intel chipset is configured to enforce hardware protection to block all direct read/write access to this area. An Intel utility is required for updating the firmware. Only firmware updates digitally signed by Intel can be applied using this utility.
Bluetooth flash (select products only)	2 Mbit	No	Yes	Stores Bluetooth configuration and firmware.	Bluetooth flash is programmed at the factory. Tools for writing data to this memory are not publicly available but can be obtained from the silicon vendor.	A utility is required for writing data to this memory and is made available through newer versions of the driver whenever the flash requires an upgrade.
802.11 WLAN EEPROM	4 Kbit to 8 Kbit	No	Yes	Stores configuration and calibration data.	802.11 WLAN EEPROM is programmed at the factory. Tools for writing data to this memory are not made public.	A utility is required for writing data to this memory and is typically not made available to the public unless a firmware upgrade is necessary to address a unique issue.
Webcam (select products only)	64 Kbit	No	Yes	Stores webcam configuration and firmware.	Webcam memory is programmed using a utility from the device manufacturer that can be run from Windows.	A utility is required for writing data to this memory and is typically not made available to the public unless a firmware upgrade is necessary to address a unique issue.
Fingerprint reader (select products only)	512 KByte flash	Yes	Yes	Stores fingerprint templates.	Fingerprint reader memory is programmed by user enrollment in HP ProtectTools Security Manager.	Only a digitally signed application can make the call to write to the flash.

Questions and answers

1. How can the BIOS settings be restored (returned to factory settings)?



IMPORTANT: Restore defaults does not securely erase any data on your hard drive. See question and answer 6 for steps to securely erase data.

Restore defaults does not reset the Custom Secure Boot keys. See question and answer 7 for information about resetting the keys.

- a. Turn on or restart the computer, and then press **esc** while the “Press the ESC key for Startup Menu” message is displayed at the bottom of the screen.
- b. Select **Main**, and then select **Apply Factory Defaults and Exit**.
- c. Follow the on-screen instructions.
- d. Select **Main**, select **Save Changes and Exit**, and then follow the on-screen instructions.

2. What is a UEFI BIOS, and how is it different from a legacy BIOS?

The Unified Extensible Firmware Interface (UEFI) BIOS is an industry-standard software interface between the platform firmware and an operating system (OS). It is a replacement for the older BIOS architecture, but supports much of the legacy BIOS functionality.

Like the legacy BIOS, the UEFI BIOS provides an interface to display the system information and configuration settings and to change the configuration of your computer before an OS is loaded. BIOS provides a secure run-time environment that supports a Graphic User Interface (GUI). In this environment, you can use either a pointing device (Touchscreen, TouchPad, pointing stick, or USB mouse) or the keyboard to navigate and make menu and configuration selections. The UEFI BIOS also contains basic system diagnostics.

The UEFI BIOS provides functionality beyond that of the legacy BIOS. In addition, the UEFI BIOS works to initialize the computer’s hardware before loading and executing the OS; the run-time environment allows the loading and execution of software programs from storage devices to provide more functionality, such as advanced hardware diagnostics (with the ability to display more detailed system information) and advanced firmware management and recovery software.

HP has provided options in Computer Setup (BIOS) to allow you to run in legacy BIOS, if required by the operating system. Examples of this requirement would be if you upgrade or downgrade the OS.

3. Where does the UEFI BIOS reside?

The UEFI BIOS resides on a flash memory chip. A utility is required to write to the chip.

4. What kind of configuration data is stored on the DIMM Serial Presence Detect (SPD) memory module? How would this data be written?

The DIMM SPD memory contains information about the memory module, such as size, serial number, data width, speed/timing, voltage, and thermal information. This information is written by the module manufacturer and stored on an EEPROM. This EEPROM cannot be written to when the memory module is installed in a computer. Third-party tools do exist that can write to the EEPROM when the memory module is not installed in a computer. Various third-party tools are available to read SPD memory.

5. What is meant by “Restore the nonvolatile memory found in Intel-based system boards”?

This message relates to clearing the Real Time Clock (RTC) CMOS memory that contains computer configuration data.

6. How can the BIOS security be reset to factory defaults and data erased?

 **IMPORTANT:** Resetting will result in the loss of information.

These steps will not reset Custom Secure Boot Keys. See question and answer 7 for information about resetting the keys.

- a. Turn on or restart the computer, and then press **esc** while the “Press the ESC key for Startup Menu” message is displayed at the bottom of the screen.
- b. Select **Main**, and then select **Reset Security to Factory Defaults**.
- c. Follow the on-screen instructions.
- d. Select **Main**, select **Save Changes and Exit**, and then follow the on-screen instructions.

7. How can the Custom Secure Boot Keys be reset?

Secure Boot is a feature to ensure that only authenticated code can start on a platform. If you enabled Secure Boot and created Custom Secure Boot Keys, simply disabling Secure Boot will not clear the keys. You must also select to clear the Custom Secure Boot Keys. Use the same Secure Boot access procedure you used to create the Custom Secure Boot Keys, but make the selection to clear or delete all Secure Boot Keys.

- a. Turn on or restart the computer, and then press **esc** while the “Press the ESC key for Startup Menu” message is displayed at the bottom of the screen.
- b. Select the **Security** menu, select **Secure Boot Configuration**, and then follow the on-screen instructions.
- c. At the **Secure Boot Configuration** window, select **Secure Boot**, select **Clear Secure Boot Keys**, and then follow the on-screen instructions to continue.

Using HP Sure Start (select models only)

Select computer models are configured with HP Sure Start, a technology that continuously monitors your computer's BIOS for attacks or corruption. If the BIOS becomes corrupted or is attacked, HP Sure Start restores the BIOS to its previously safe state, without user intervention. Those select computer models ship with HP Sure Start configured and enabled. HP Sure Start is configured and already enabled so that most users can use the HP Sure Start default configuration. The default configuration can be customized by advanced users.

To access the latest documentation on HP Sure Start, go to <http://www.hp.com/support>. Select **Find your product**, and then follow the on-screen instructions.

C Specifications

Head unit (without MSR or stand)		
Length	336.2 mm	13.2 in
Depth	216.4 mm	8.5 in
Height	17.6 mm	0.7 in
Rotate/tilt stand & fixed position stand/Column printer		
Length	96.0 mm	3.8 in
Depth	96.0 mm	3.8 in
Height	220.0 mm/260.0 mm	8.7 in/10.2 in
Retail I/O Connectivity Base		
Length	284.0 mm	11.2 in
Depth	162.0 mm	6.4 in
Height	29.2 mm	1.1 in
Weight	0.6 kg	1.3 lbs
Display Head Unit with collar (without stand)		
Weight	1.4 kg	3.1 lbs
Rotate/Tilt Stand		
Weight	1.3 kg	3.0 lbs
Fixed Position Stand		
Weight	1.1 kg	2.4 lbs
Temperature Range		
Operating	50° to 95°F	10° to 35°C
Nonoperating	-22° to 140°F	-30° to 60°C
Relative Humidity (noncondensing)		
Operating	20-85%	20-85%
Maximum Altitude (unpressurized)		
Operating	10,000 ft	3048 m
Nonoperating	30,000 ft	9144 m
Power Supply		
Rated Line Frequency	180W, 120W, 65W	
	50-60 Hz	

Operating Line Frequency

47-63 Hz

- ¹ This system utilizes an active power factor corrected power supply. This allows the system to pass the CE mark requirements for use in the countries of the European Union. The active power factor corrected power supply also has the added benefit of not requiring an input voltage range select switch.
- ² High efficiency power supply is a requirement for ENERGY STAR[®] qualification in conjunction with a select range of processors and modules.

Index

- A**
 - access panel
 - locked 106
 - antennas
 - removal and replacement 62
 - audible codes 93
- B**
 - battery
 - disposal 16
 - beep codes 93
 - booting options
 - Full Boot 88
 - Quick Boot 88
- C**
 - cable routing configurations 70
 - cautions
 - AC power 14
 - cables 15
 - electrostatic discharge 16
 - CFD 43
 - changing a Power-On password 96
 - changing a Setup password 96
 - CMOS
 - backing up 95
 - clearing and resetting 97
 - column printer
 - changing paper 64
 - cleaning 69
 - features 63
 - latch failsafe 69
 - paper specifications 65
 - qualified paper grades 65
 - removing 35
 - troubleshooting 66
 - computer operating guidelines 14
 - Computer Setup
 - access problem 104
 - connecting AC adapter 6
 - counter top mount 30
 - country power cord set requirements 123
 - Customer Support 101
- D**
 - deleting a Power-On password 97
 - deleting a Setup password 97
 - disassembly preparation 19
 - display panel
 - illustrated 10
 - removing 41
- E**
 - electrostatic discharge (ESD) 16
 - preventing damage 16
 - error
 - codes 88, 93
 - messages 88
- F**
 - F10 Setup
 - access problem 104
 - fan
 - removal and replacement 52
 - fan assembly
 - illustrated 11
 - features 1, 3
 - fingerprint reader
 - attaching to base 25
 - connecting as standalone 24
 - flash drive problems 114
 - flashing LEDs 93
- G**
 - general problems 104
 - grounding methods 17
- H**
 - hardware installation problems 109
 - head unit adjustment 8
 - head unit security screw
 - with stand 34
 - with VESA mount 35
 - heat sink
 - illustrated 11
 - removing 51
 - helpful hints 102
 - HP PC Hardware Diagnostics (UEFI)
 - using 99
 - HP Sure Start 129
- I**
 - I/O connectivity base
 - advanced components 5
 - attaching fingerprint reader 25
 - attaching to computer 20, 22
 - basic components 4
 - connecting power 6
 - installing
 - CFD 43
 - SSD 48
 - Internet access problems 114
- M**
 - memory
 - nonvolatile 124
 - problems 112
 - removing and installing 45
 - specifications 45
 - volatile 124
 - memory modules
 - illustrated 11
 - MSR
 - maintenance 15
 - MSR (Magnetic Stripe Reader)
 - assembly
 - removal and replacement 55
 - MSR board and cable
 - illustrated 10
 - MSR LED board
 - removal 58
 - MSR LED board and cable
 - illustrated 10
- N**
 - network problems 110
 - nonvolatile memory 124
 - numeric error codes 88
- P**
 - password
 - clearing 95
 - power-on 95
 - setup 95

- passwords 96, 97
- peripherals 12
- POST error messages 88
- power button
 - computer 7
 - I/O connectivity base 7
- power button board
 - illustrated 11
 - removal and replacement 54
- power cord set requirements
 - country specific 123
- power supply
 - operating voltage range 130
- Power-On password 96, 97
- power-on password 95
- printer problems 108
- problems
 - Computer Setup 104
 - F10 Setup 104
 - flash drive 114
 - general 104
 - hardware installation 109
 - Internet access 114
 - memory 112
 - network 110
 - printer 108
 - retail system 103
 - software 116

R

- removal and replacement
 - antennas 62
 - fan 52
 - MSR (Magnetic Stripe Reader)
 - assembly 55
 - power button board 54
 - speakers 53
 - system board 59
- removal and replacement procedures
 - heat sink 51
 - thermal module 51
 - WLAN module 49
- removing
 - MSR LED board 58
- removing personal data from volatile
 - system memory 124
- resetting
 - CMOS 95
 - password jumper 95

S

- safety and comfort 101
- screws, correct size 15
- security cable
 - attaching to computer 33
 - attaching to I/O connectivity
 - base 32
- serial number
 - computer 9
 - I/O connectivity base 9
- serial ports, configuring for power
 - 22
- service considerations 15
- Setup password 96, 97
- setup password 95
- software
 - problems 116
 - servicing computer 15
- software configuration 76
- solid-state drive
 - illustrated 11
- speakers
 - illustrated 11
 - removal and replacement 53
- specifications
 - computer 130
- SSD storage device 48
- stand
 - options 4
 - removing head unit 27
- static electricity 16
- system board
 - illustrated 10
 - removal and replacement 59
- system board components 42
- system memory, removing personal
 - data from volatile 124

T

- tamper-proof screws
 - tool 15
- thermal module
 - removing 51
- tools, servicing 15
- Torx T15 screwdriver 15
- touch screen maintenance 14

V

- VESA mount 28

W

- Windows 10
 - backup and restore 117
- WLAN module
 - illustrated 11
 - removing 49