

# Alienware AW2521HFA/ AW2521HFLA Monitor User's Guide

Model: AW2521HFA/AW2521HFLA  
Regulatory model: AW2521HFb

A L I E N W A R E™ 

# Notes, cautions, and warnings

-  **NOTE:** A NOTE indicates important information that helps you make better use of your computer.
-  **CAUTION:** A CAUTION indicates potential damage to hardware or loss of data if instructions are not followed.
-  **WARNING:** A WARNING indicates a potential for property damage, personal injury, or death.

© 2020 Dell Inc. or its subsidiaries. All rights reserved. Dell, EMC, and other trademarks are trademarks of Dell Inc. or its subsidiaries. Other trademarks may be trademarks of their respective owners

2020 - 11

Rev. A00

# Contents

<b>About your monitor</b> .....	<b>6</b>
Package contents .....	6
Product features .....	8
Identifying parts and controls .....	9
Front view .....	9
Back view .....	10
Rear and bottom view .....	11
<b>Monitor specifications</b> .....	<b>12</b>
<b>Resolution specifications</b> .....	<b>14</b>
Supported video modes .....	14
Preset display modes .....	15
Electrical specifications .....	15
Physical characteristics .....	16
Environmental characteristics .....	17
Power management modes .....	18
Pin assignments .....	19
<b>Plug and Play capability</b> .....	<b>20</b>
<b>Universal Serial Bus (USB) interface</b> .....	<b>21</b>
USB upstream connector .....	21
USB downstream connector .....	22
USB ports .....	22
<b>LCD monitor quality and pixel policy</b> .....	<b>23</b>
<b>Maintenance guidelines</b> .....	<b>23</b>
Cleaning your monitor .....	23
<b>Setting up the monitor</b> .....	<b>24</b>
Attaching the stand .....	24
Connecting the computer .....	29

Removing the monitor stand .....	30
VESA wall mounting (optional).....	32
<b>Operating the monitor.....</b>	<b>33</b>
Power on the monitor .....	33
Using the joystick control.....	33
Using the rear-panel controls .....	34
Using the On-Screen Display (OSD) menu.....	35
Accessing the menu system .....	35
OSD warning message .....	46
Locking the rear-panel control buttons .....	49
Setting the maximum resolution .....	50
Using the tilt, swivel, and vertical extension .....	51
Tilt and swivel extensions .....	51
Vertical extension .....	51
Rotating the monitor .....	52
Rotate clockwise.....	52
Rotate counterclockwise.....	53
Adjusting the rotation display settings of your system ...	54
<b>Using AlienFX application.....</b>	<b>55</b>
Prerequisites .....	55
Installing AWCC through Windows update .....	55
Installing AWCC from the Dell Support website .....	55
Navigating the AlienFX window.....	56
Creating a theme .....	58
Setting lighting effects.....	59
<b>Troubleshooting .....</b>	<b>62</b>
Self-test.....	62
Built-in diagnostics .....	63
Common problems.....	64
Product specific problems .....	66

Universal Serial Bus (USB) specific problems. . . . .67

**Appendix . . . . .68**

FCC notices (U.S. only) and other regulatory  
information. . . . .68



Contact Dell. . . . .68





# About your monitor

## Package contents

Your monitor ships with the components shown below. If any component is missing, contact Dell technical support. For more information see [Contact Dell](#).

 **NOTE: Some components may be optional and may not ship with your monitor. Some features or media may not be available in certain countries.**

Component image	Component description
	Monitor
	Stand riser
	Stand base

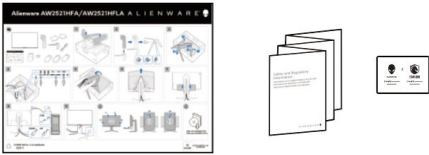
	<p>I/O cover</p>
	<p>Power cable (varies by country)</p>
	<p>DisplayPort cable (DisplayPort to DisplayPort)</p>
	<p>HDMI cable</p>
	<p>USB 3.0 upstream cable (enables the USB ports on the monitor)</p>
	<ul style="list-style-type: none"> <li>▪ Quick Setup Guide</li> <li>▪ Safety, Environmental, and Regulatory Information</li> <li>▪ Alienware Welcome Card</li> </ul>

## Product features

The **Alienware 25 Gaming** monitor is available in two color variants: *Dark Side of the Moon* (**AW2521HFA**) and *Lunar Light* (**AW2521HFLA**). Both monitors offer active matrix, Thin-Film Transistor (TFT), Liquid Crystal Display (LCD) and LED backlight.

The monitor features include:

- 62.2 cm (24.5 inch) viewable area (measured diagonally). Resolution: Up to 1920 x 1080 through DisplayPort and HDMI, with full-screen support or lower resolutions, supporting a high refresh rate of 240 Hz.
- NVIDIA® G-SYNC® Compatible Certification and AMD FreeSync™ Premium Technology minimizes graphic distortions like screen tearing and stuttering for smoother, fluid gameplay.
- Supports an extremely high refresh rate of 240 Hz and a rapid response time of 1 ms gray to gray in **Extreme** mode\*.
- Color gamut of sRGB 99%.
- Tilt, swivel, pivot, and height adjustment capabilities.
- Removable stand and Video Electronics Standards Association (VESA™) 100 mm mounting holes for flexible mounting solutions.
- Digital connectivity through 1 DisplayPort and 2 HDMI ports.
- Equipped with 1 USB upstream port and 4 USB downstream ports.
- Plug and play capability if supported by your system.
- On-Screen Display (OSD) adjustments for ease of setup and screen optimization.
- AW2521HFA/AW2521HFLA offers preset modes such as FPS (First-Person Shooter), MOBA/RTS (Real-Time Strategy), RPG (Role-Playing Game), SPORTS (Racing) and three customizable game modes as per user preference. In addition, key enhanced gaming features such as Timer, Frame Rate, and Display Alignment are provided to help improve gamer's performance and provide best in-game advantage.
- 0.3 W in Standby mode.
- Optimize eye comfort with a flicker-free screen.

**⚠ WARNING: The possible long-term effects of blue light emission from the monitor may cause damage to the eyes, including eye fatigue, digital eye strain, and so on. ComfortView feature is designed to reduce the amount of blue light emitted from the monitor to optimize eye comfort.**



\* The 1 ms gray-to-gray mode is achievable in the **Extreme** mode to reduce visible motion blur and increased image responsiveness. However, this may introduce some slight and noticeable visual artifacts into the image. As every system setup and every gamer's needs are different, Alienware recommends that users experiment with the different modes to find the setting that is right for them.

## Identifying parts and controls

### Front view

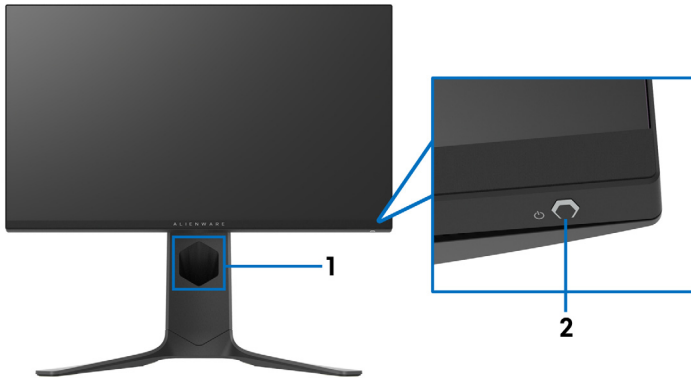

Label	Description	Use
1	Cable-management slot (on the front side of the stand)	To organize the cables neatly.
2	Power On/Off button (with LED indicator)	To turn the monitor on or off.

## Back view

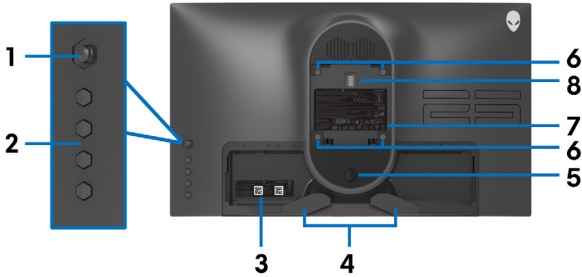

### Back view without monitor stand

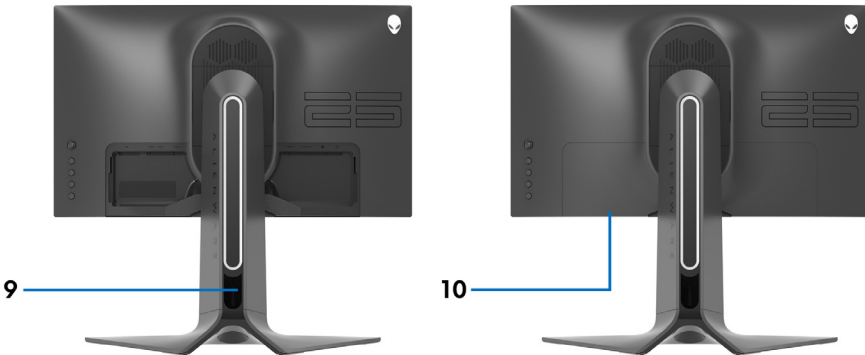

### Back view with monitor stand

Label	Description	Use
1	Joystick	Use it to control the OSD menu.
2	Function buttons	For more information, see <a href="#">Operating the monitor</a> .
3	Barcode, serial number, and Service Tag label	Refer to this label if you need to contact Dell for technical support.
4	Cable-management clips	To organize the cables neatly.
5	Stand release button	Releases stand from the monitor.
6	VESA mounting holes (100 mm x 100 mm - behind VESA Cover)	Wall mount monitor using VESA-compatible wall mount kit (100 mm x 100 mm).

<b>7</b>	Regulatory label	Lists the regulatory approvals.
<b>8</b>	Lighting dock connector	When the stand riser is attached to the monitor, the dock connector supplies power to the light on the stand.
<b>9</b>	Cable-management slot (at the back of the stand)	To organize cables by routing them through this slot.
<b>10</b>	I/O cover	Protects the I/O ports.

### Rear and bottom view

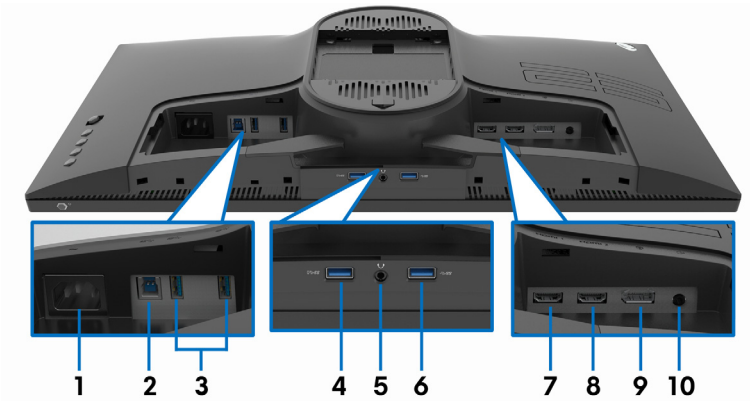

### Rear and bottom view without monitor stand

<b>Label</b>	<b>Description</b>	<b>Use</b>
<b>1</b>	Power connector	Connect the power cable (shipped with your monitor).
<b>2</b>	USB upstream port	Connect the USB cable (shipped with your monitor) to this port and your computer to enable the USB ports on your monitor.
<b>3</b>	USB 3.0 ports (2)	Connect your USB device.* <b>NOTE:</b> To use these ports, you must connect the USB cable (shipped with your monitor) to the USB-upstream port on the monitor and to your computer.
<b>4</b>	USB 3.0 port with Power Charging	Connect to charge your USB device.

<b>5</b>	Headphone port	Connect headphone or speakers. <b>CAUTION: Increasing the audio output beyond 50% on the volume control or equalizer may increase the output voltage on the headphones thereby increasing the sound pressure levels.</b>
<b>6</b>	USB 3.0 port	Connect your USB device.* <b>NOTE:</b> To use these ports, you must connect the USB cable (shipped with your monitor) to the USB-upstream port on the monitor and to your computer.
<b>7</b>	HDMI port (HDMI 1)	Connect to a computer or another HDMI output device.
<b>8</b>	HDMI port (HDMI 2)	Connect to a computer or another HDMI output device.
<b>9</b>	DisplayPort	Connect to a computer or another DisplayPort output device.
<b>10</b>	Line-out port	Connect your speakers. <b>NOTE:</b> This port does not support headphones.

\* To avoid signal interference, when a wireless USB device has been connected to a USB downstream port, it is not recommended to connect any other USB devices to the adjacent port.

## Monitor specifications

<b>Model</b>	<b>AW2521HFA/AW2521HFLA</b>
Screen type	Active matrix - TFT LCD
Panel technology	Fast IPS
Aspect ratio	16:9
Viewable image	
Diagonal	622.28 mm (24.5 in.)
Width (active area)	543.744 mm (21.41 in.)
Height (active area)	302.616 mm (11.91 in.)
Total area	164545.63 mm <sup>2</sup> (255.04 in <sup>2</sup> )

Pixel pitch	0.2832 mm x 0.2802 mm
Pixel per inch (PPI)	90
Viewing angle	
Vertical	178° (typical)
Horizontal	178° (typical)
Luminance output	400 cd/m <sup>2</sup> (typical)
Contrast ratio	1000 to 1 (typical)
Faceplate coating	Anti-glare treatment of the front polarizer (Haze 25%, 3H)
Backlight	WLED
Response time	<ul style="list-style-type: none"> <li>▪ 1 ms gray to gray in <b>Extreme</b> Mode *</li> <li>▪ 2 ms gray to gray in <b>Super Fast</b> Mode</li> <li>▪ 4 ms gray to gray in <b>Fast</b> Mode</li> </ul> <p>* A 1 ms gray-to-gray response time is achieved in the <b>Extreme</b> mode to reduce visible motion blur and increase image responsiveness. However, this may introduce subtle visual artifacts into the image. Since each computer configuration and gamer's needs are different, Alienware recommends that users experiment with the different modes to find the setting that is right for them.</p>
Color depth	16.78 million colors
Color gamut	sRGB 99% (typical)
Built-in devices	<ul style="list-style-type: none"> <li>▪ USB 3.0 Super-Speed hub (with 1 USB 3.0 upstream port)</li> <li>▪ 4 x USB 3.0 downstream port (including 1 port which supports power-charging)</li> </ul>
Connectivity	<ul style="list-style-type: none"> <li>▪ 1 x DisplayPort version 1.2 (rear)</li> <li>▪ 2 x HDMI port version 2.0 (rear)</li> <li>▪ 1 x USB 3.0 upstream port (rear)</li> <li>▪ 3 x USB 3.0 downstream ports (bottom: 1; rear: 2)</li> <li>▪ 1 x USB 3.0 downstream port with BC1.2 charging capability at 2 A (maximum) (bottom)</li> <li>▪ 1 x headphone port (bottom)</li> <li>▪ 1 x audio line-out port (rear)</li> </ul>

Bezel width (edge of monitor to active area)	
Top	5.27 mm
Left/Right	5.27 mm/5.27 mm
Bottom	14.19 mm
Adjustability	
Height adjustable stand	0 to 130 mm
Tilt	-5° to 21°
Swivel	-20° to 20°
Pivot	-90° to 90°
Dell Display Manager (DDM) Compatibility	Easy Arrange and other key features

## Resolution specifications

Model	AW2521HFA/AW2521HFLA	
	DisplayPort 1.2	HDMI 2.0
Horizontal scan range	255 to 255 kHz (automatic)	30 to 255 kHz (automatic)
Vertical scan range	48 to 240 Hz (automatic)	48 to 240 Hz (automatic)
Maximum preset resolution	1920 x 1080 @ 240 Hz	1920 x 1080 @ 240 Hz

## Supported video modes

Model	AW2521HFA/AW2521HFLA
Video display capabilities (HDMI & DisplayPort playback)	480i, 480p, 576i, 576p, 720p, 1080i, 1080p, FHD

## Preset display modes

Display mode	Horizontal frequency (kHz)	Vertical frequency (Hz)	Pixel clock (MHz)	Sync polarity (Horizontal/Vertical)
VESA, 640 x 480	31.5	59.9	25.2	-/-
VESA, 640 x 480	37.5	75.0	31.5	-/-
IBM, 720 x 400	31.5	70.1	28.3	-/+
VESA, 800 x 600	37.9	60.3	40.0	+/+
VESA, 800 x 600	46.9	75.0	49.5	+/+
VESA, 1024 x 768	48.4	60.0	65.0	-/-
VESA, 1024 x 768	60.0	75.0	78.8	+/+
VESA, 1152 x 864	67.5	75.0	108.0	+/+
VESA, 1280 x 1024	64.0	60.0	108.0	+/+
VESA, 1280 x 1024	80.0	75.0	135.0	+/+
VESA, 1600 x 900	60.0	60.0	108.0	+/+
VESA, 1920 x 1080	67.5	60.0	148.5	+/+
1920 x 1080	137.3	120.0	285.5	+/-
1920 x 1080	166.6	144.0	346.5	+/-
1920 x 1080	278.1	240.0	567.4	+/-

 **NOTE: This monitor supports AMD FreeSync™ Premium Technology.**

## Electrical specifications

Model	AW2521HFA/AW2521HFLA
Video input signals	HDMI 2.0*/DisplayPort 1.2, 600 mV for each differential line, 100 ohm input impedance per differential pair.
AC input voltage/frequency/current	100 VAC to 240 VAC / 50 Hz or 60 Hz $\pm$ 3 Hz / 1.5 A (typical)
Inrush current	<ul style="list-style-type: none"> <li>▪ 120 V: 30 A (max.) at 0°C (cold start)</li> <li>▪ 240 V: 60 A (max.) at 0°C (cold start)</li> </ul>

\* Does not support the HDMI 2.0 optional specification, including Consumer Electronics Control (CEC), HDMI Ethernet Channel (HEC), Audio Return

Channel (ARC), standard for 3D format and resolutions, and standard for 4K digital cinema resolution.

**Physical characteristics**

<b>Model</b>	<b>AW2521HFA/AW2521HFLA</b>
<b>Signal cable type</b>	<ul style="list-style-type: none"> <li>▪ Digital: HDMI, 19 pins</li> <li>▪ Digital: DisplayPort, 20 pins</li> <li>▪ Universal Serial Bus: USB, 9 pins</li> </ul>
<b>NOTE:</b> Dell monitors are designed to work optimally with the video cables that are shipped with your monitor. As Dell does not have control over the different cable suppliers in the market, the type of material, connector and process used to manufacture these cables, Dell does not guarantee video performance on cables that are not shipped with your Dell monitor.	
<b>Dimensions (with stand)</b>	
Height (extended)	526.08 mm (20.71 in.)
Height (compressed)	421.21 mm (16.58 in.)
Width	556.29 mm (21.90 in.)
Depth	251.92 mm (9.92 in.)
<b>Dimensions (without stand)</b>	
Height	328.24 mm (12.92 in.)
Width	556.29 mm (21.90 in.)
Depth	72.95 mm (2.87 in.)
<b>Stand dimensions</b>	
Height (extended)	436.80 mm (17.20 in.)
Height (compressed)	421.21 mm (16.58 in.)
Width	465.30 mm (18.32 in.)
Depth	251.92 mm (9.92 in.)
<b>Weight</b>	
Weight with packaging	11.22 kg (24.71 lb)
Weight with stand assembly and cables	7.17 kg (15.79 lb)



Weight without stand assembly (For wall mount or VESA mount considerations - no cables)	3.55 kg (7.81 lb)
Weight of stand assembly	3.21 kg (7.07 lb)
Front frame gloss	17 ± 3 (only front chin)

### Environmental characteristics

<b>Model</b>	<b>AW2521HFA/AW2521HFLA</b>
<b>Compliant standards</b>	
Arsenic-free glass and mercury-free for the panel only	
<b>Temperature</b>	
Operating	0°C to 40°C (32°F to 104°F)
Non-operating	<ul style="list-style-type: none"> <li>▪ Storage: -20°C to 60°C (-4°F to 140°F)</li> <li>▪ Shipping: -20°C to 60°C (-4°F to 140°F)</li> </ul>
<b>Humidity</b>	
Operating	10% to 80% (non-condensing)
Non-operating	<ul style="list-style-type: none"> <li>▪ Storage: 5% to 90% (non-condensing)</li> <li>▪ Shipping: 5% to 90% (non-condensing)</li> </ul>
<b>Altitude</b>	
Operating	5,000 m (16,404 ft) (maximum)
Non-operating	12,192 m (40,000 ft) (maximum)
<b>Thermal dissipation</b>	<ul style="list-style-type: none"> <li>▪ 245.66 BTU/hour (maximum)</li> <li>▪ 81.89 BTU/hour (typical)</li> </ul>

## Power management modes

If you have a VESA DPM™ compliant display card or software installed on your computer, the monitor can automatically reduce its power consumption when not in use. This is referred to as **Standby mode\***. If the computer detects input from the keyboard, mouse, or other input devices, the monitor automatically resumes to function. The following table shows the power consumption and signaling of this automatic power saving feature:

VESA modes	Horizontal sync	Vertical sync	Video	Power indicator	Power consumption
Normal operation	Active	Active	Active	Blue	72 W (maximum)** 21 W (typical)
Active-off mode	Inactive	Inactive	Blanked	White (blinking)	Less than 0.3 W
Switch off	-	-	-	Off	Less than 0.3 W

Power Consumption $P_{on}$	17.18 W
Total Energy Consumption (TEC)	55.52 kWh

\* Zero power consumption in OFF mode can only be achieved by disconnecting the main cable from the monitor.

\*\* Maximum power consumption with max luminance, and USB active.

This document is informational only and reflects laboratory performance. Your product may perform differently, depending on the software, components and peripherals you ordered and shall have no obligation to update such information. Accordingly, the customer should not rely upon this information in making decisions about electrical tolerances or otherwise. No warranty as to accuracy or completeness is expressed or implied.

### NOTE:

**$P_{on}$ : Power consumption of On mode measured with reference to Energy Star test method.**

**TEC: Total energy consumption in kWh measured with reference to Energy Star test method.**

## Pin assignments

### DisplayPort connector

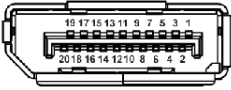

Pin number	20-pin side of the connected signal cable
1	ML3 (n)
2	GND
3	ML3 (p)
4	ML2 (n)
5	GND
6	ML2 (p)
7	ML1 (n)
8	GND
9	ML1 (p)
10	ML0 (n)
11	GND
12	ML0 (p)
13	GND
14	GND
15	AUX (p)
16	GND
17	AUX (n)
18	Hot Plug Detect
19	Re-PWR
20	+3.3 V DP_PWR

## HDMI connector

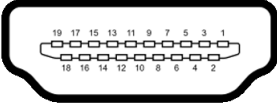

Pin number	19-pin side of the connected signal cable
1	TMDS DATA 2+
2	TMDS DATA 2 SHIELD
3	TMDS DATA 2-
4	TMDS DATA 1+
5	TMDS DATA 1 SHIELD
6	TMDS DATA 1-
7	TMDS DATA 0+
8	TMDS DATA 0 SHIELD
9	TMDS DATA 0-
10	TMDS CLOCK+
11	TMDS CLOCK SHIELD
12	TMDS CLOCK-
13	CEC
14	Reserved (N.C. on device)
15	DDC CLOCK (SCL)
16	DDC DATA (SDA)
17	DDC/CEC Ground
18	+5V POWER
19	HOT PLUG DETECT

## Plug and Play capability

You can connect the monitor to any Plug and Play-compatible system. The monitor automatically provides the computer system with its Extended Display Identification Data (EDID) using Display Data Channel (DDC) protocols so that the system can configure itself and optimize the monitor settings. Most monitor installations are automatic; you can select different settings if desired. For more information about changing the monitor settings, see [Operating the monitor](#).

## Universal Serial Bus (USB) interface

This section gives you information about the USB ports that are available on the monitor.

 **NOTE:** This monitor is Super-Speed USB 3.0 compatible.

Transfer speed	Data rate	Power consumption*
Super-Speed	5 Gbps	4.5 W (Max, each port)
High speed	480 Mbps	4.5 W (Max, each port)
Full speed	12 Mbps	4.5 W (Max, each port)

\* Up to 2 A on USB downstream port (with  battery icon) with battery charging version-compliant devices or normal USB devices.

### USB upstream connector

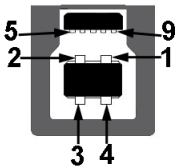

Pin number	9-pin side of the connector
1	VCC
2	D-
3	D+
4	GND
5	SSTX-
6	SSTX+
7	GND
8	SSRX-
9	SSRX+

## USB downstream connector



Pin number	9-pin side of the connector
1	VCC
2	D-
3	D+
4	GND
5	SSRX-
6	SSRX+
7	GND
8	SSTX-
9	SSTX+

## USB ports

- 1 x upstream - rear
- 2 x downstream - rear
- 2 x downstream - bottom

Power charging port - the port with  icon; supports up to 2 A fast-charging capability if the device is BC1.2 compatible.

 **NOTE: USB 3.0 functionality requires a USB 3.0-capable computer.**

 **NOTE: The USB ports on the monitor work only when the monitor is turned on or in Standby mode. If you turn off the monitor and then turn it on, the attached peripherals may take a few seconds to resume normal functionality.**

## LCD monitor quality and pixel policy

During the LCD monitor manufacturing process, it is not uncommon for one or more pixels to become fixed in an unchanging state, which are hard to see and do not affect the display quality or usability. For more information on Dell Monitor Quality and Pixel Policy, see [www.dell.com/pixelguidelines](http://www.dell.com/pixelguidelines).

## Maintenance guidelines

### Cleaning your monitor

- △ **CAUTION:** Read and follow the **Safety instructions** before cleaning the monitor.
- ⚠ **WARNING:** Before cleaning the monitor, unplug the monitor power cable from the electrical outlet.

For best practices, follow the instructions in the list below when unpacking, cleaning, or handling your monitor:

- To clean your anti-static screen, lightly dampen a soft, clean cloth with water. If possible, use a special screen-cleaning tissue or solution suitable for the anti-static coating. Do not use benzene, thinner, ammonia, abrasive cleaners, or compressed air.
- Use a lightly-dampened, warm cloth to clean the monitor. Avoid using detergent of any kind as some detergents leave a milky film on the monitor.
- If you notice white powder when you unpack your monitor, wipe it off with a cloth.
- Handle your monitor with care as a darker-colored monitor may get scratched and show white scuff marks more than a lighter-colored monitor.
- To help maintain the best image quality on your monitor, use a dynamically changing screen saver and turn off your monitor when not in use.

# Setting up the monitor

## Attaching the stand

- ✎ **NOTE:** The stand is not factory-installed.
  - ✎ **NOTE:** The following instructions are only applicable for the stand that was shipped with your monitor. If you are attaching a stand that you purchased from any other source, follow the set up instructions that were included with the stand.
- △ **CAUTION:** The following steps are important to protect your curved screen. Do follow the instructions below to finish up the installation.
1. Remove the stand riser and stand base from the packaging cushion.

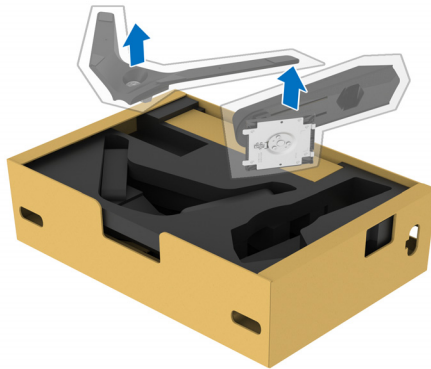

2. Align and place the stand riser on the stand base.
3. Open the screw handle at the bottom of the stand base and turn it clockwise to secure the stand assembly.
4. Close the screw handle.





5. Open the protective cover on the monitor to access the VESA slot on the monitor.

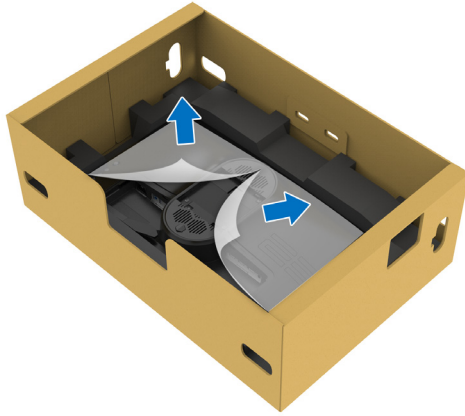

6. Carefully insert the tabs on the stand riser into the slots on the display back cover and lower the stand assembly to snap it into place.



7. Route the power cable through the cable-management slot on the stand and then through the cable-management clip at the back of the display.
8. Connect the power cable to the monitor.

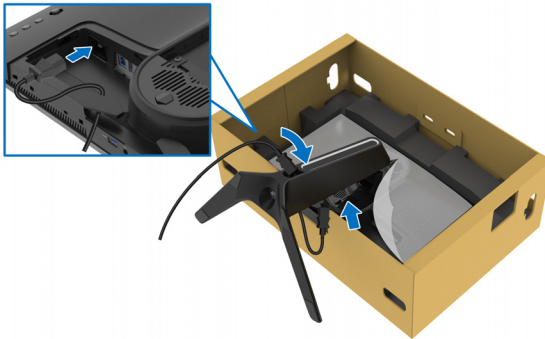

9. Route the required cables, such as USB upstream cable, USB downstream cables (optional, cables are not included), HDMI cable, and DisplayPort cable through the cable-management slot on the stand.
10. Connect the required cables to the monitor.

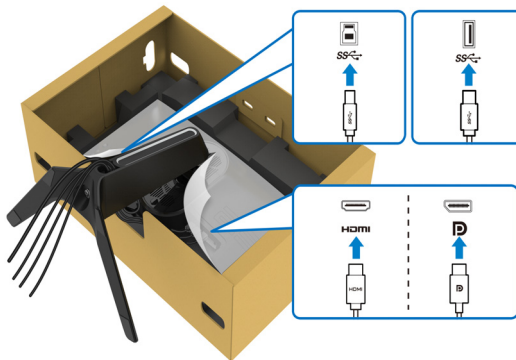

**NOTE:** Dell monitors are designed to work optimally with Dell supplied inbox cables. Dell does not guarantee the video quality and performance when using non-Dell cables.

**NOTE:** Route each cable neatly so that the cables are organized before the I/O cover is attached.

**CAUTION:** Do not plug the power cable into the wall outlet or turn on the monitor until you are instructed to do so.

11. Hold the stand riser and lift the monitor carefully, then place it on a flat surface.



△ **CAUTION: Hold the stand riser firmly when lifting the monitor to avoid any accidental damage.**

12. Lift the protective cover from the monitor.

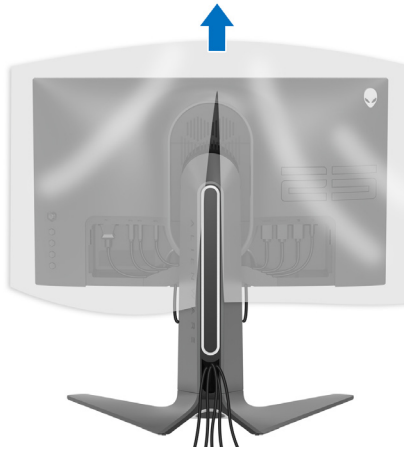

13. Slide the tabs on the I/O cover into the slots on the display back cover until it snaps into place.

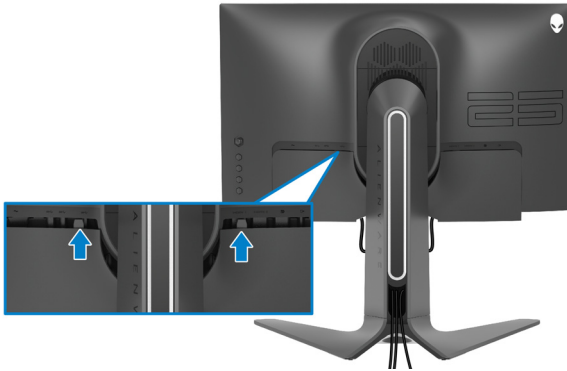

**NOTE:** Ensure that all cables pass through the I/O cover and cable-management slot on the stand riser.

## Connecting the computer

**⚠ WARNING:** Before you begin any of the procedures in this section, follow the [Safety instructions](#).

**✍ NOTE:** Do not connect all cables to the computer at the same time.

**✍ NOTE:** The images are for the purpose of illustration only. Appearance of the computer may vary.

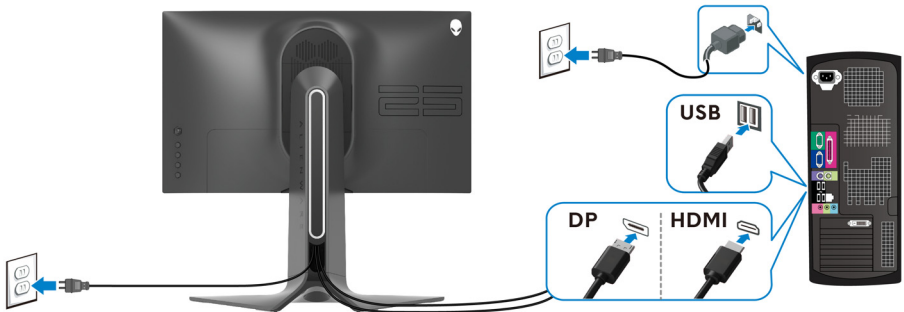

To connect your monitor to the computer:



1. Connect the other end of the DisplayPort cable or HDMI cable to your computer.
2. Connect the other end of the USB 3.0 upstream cable to an appropriate USB 3.0 port on your computer.
3. Connect the USB 3.0 peripherals to the USB 3.0 downstream ports on the monitor.
4. Plug the power cables for your computer and monitor into a wall outlet.
5. Turn on the monitor and the computer.

If your monitor displays an image, installation is complete. If it does not display an image, see [Common problems](#).

## Removing the monitor stand

-  **NOTE:** To prevent scratches on the display when removing the stand, ensure that the monitor is placed on a soft, clean surface.
-  **NOTE:** The following instructions are applicable only for attaching the stand that was shipped with your monitor. If you are attaching a stand that you purchased from any other source, follow the set up instructions that were included with the stand.

To remove the stand:

1. Turn off the monitor.
2. Disconnect the cables from the computer.
3. Place the monitor on a soft cloth or cushion.
4. Carefully slide and remove the I/O cover from the monitor.



5. Disconnect the cables from the monitor and slide them out through the cable-management slot on the stand riser.

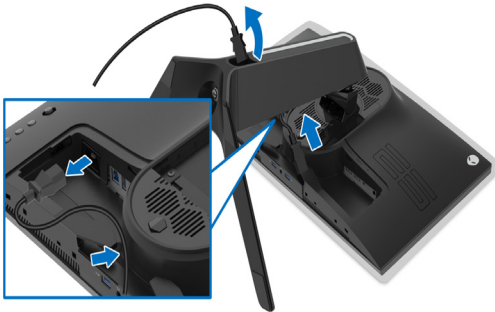

6. Press and hold the stand release button.



7. Lift the stand up and away from the monitor.

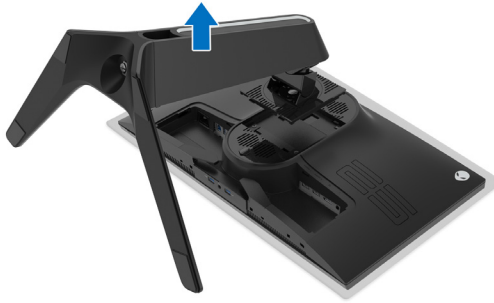

## VESA wall mounting (optional)



(Screw dimension: M4 x 10 mm)

Refer to the instructions that come with the VESA-compatible wall mounting kit.

1. Place the monitor panel on a soft cloth or cushion on a stable flat surface.
2. Remove the monitor stand. (See [Removing the monitor stand.](#))
3. Use a Phillips crosshead screwdriver to remove the four screws securing the plastic cover.
4. Attach the mounting bracket from the wall mounting kit to the monitor.
5. Mount the monitor on the wall. For more information, see the documentation that shipped with the wall mounting kit.

 **NOTE: For use only with UL-listed wall mount bracket with minimum weight or load bearing capacity of 14.2 kg.**



# Operating the monitor

## Power on the monitor

Press the power button to turn on the monitor.

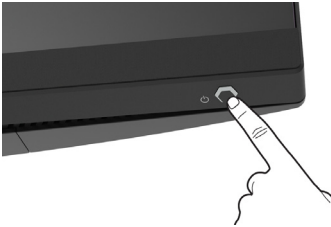

## Using the joystick control

Use the joystick control on the rear of the monitor to make OSD adjustments.

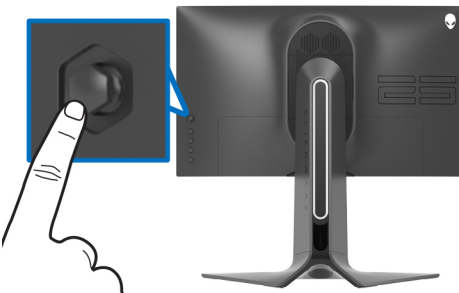

1. Press the joystick button to launch the OSD main menu.
2. Move the joystick up/down/left/right to toggle between options.
3. Press the joystick button again to confirm the settings and exit.

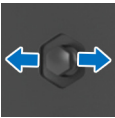
Joystick	Description
	<ul style="list-style-type: none"><li>▪ When the OSD menu is on, press the button to confirm the selection or save the settings.</li><li>▪ When the OSD menu is off, press the button to launch the OSD main menu. See <a href="#">Accessing the menu system</a>.</li></ul>
	<ul style="list-style-type: none"><li>▪ For 2-way (right and left) directional navigation.</li><li>▪ Move right to enter the submenu.</li><li>▪ Move left to exit from the submenu.</li><li>▪ Increases (right) or decreases (left) the parameters of selected menu item.</li></ul>

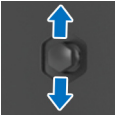



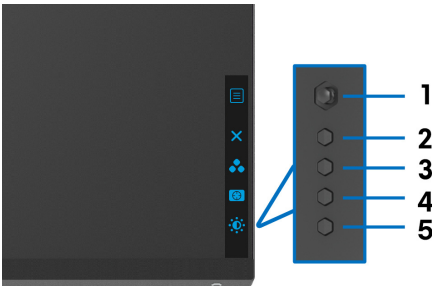

- For 2-way (up and down) directional navigation.
- Toggles between the menu items.
- Increases (up) or decreases (down) the parameters of selected menu item.

## Using the rear-panel controls

Use the control buttons on the rear of the monitor to access the OSD menu and shortcut keys.



The following table describes the rear-panel buttons:

Rear-panel button	Description
1  Menu	To launch the OSD main menu. See <a href="#">Accessing the menu system</a> .
2  Exit	To exit the OSD main menu.
3  Shortcut key/Preset Modes	To specify a desired color mode from a preset list.
4  Shortcut key/Dark Stabilizer	To directly access the <b>Dark Stabilizer</b> adjustment slider.
5  Shortcut key/Brightness/Contrast	To directly access the <b>Brightness/Contrast</b> adjustment sliders.

When you press any of these buttons (excluding the joystick button), the OSD Status Bar appears to let you know the current settings of some OSD functions.

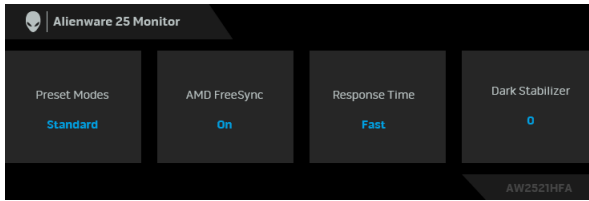

## Using the On-Screen Display (OSD) menu

### Accessing the menu system

Icon	Menu and submenus	Description
------	-------------------	-------------



#### Game

Use this menu to personalize your visual gameplay experience.

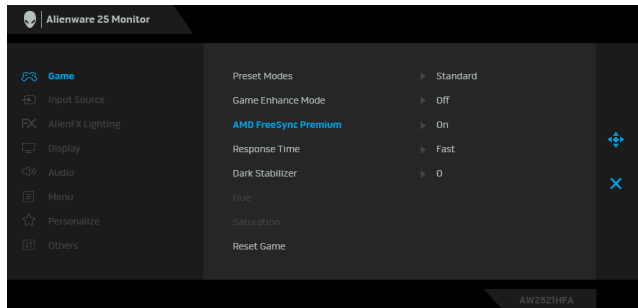

**Preset Modes** Allows you to choose from a list of preset color modes.

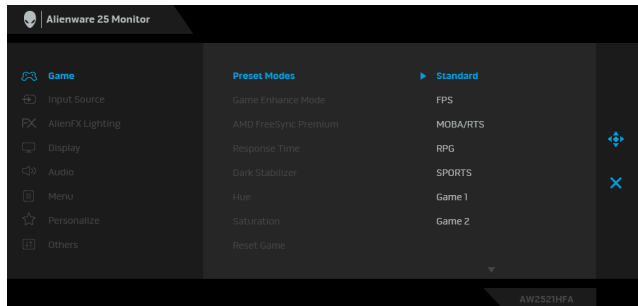

- **Standard:** Loads the monitor's default color settings. This is the default preset mode.
- **FPS:** Loads color settings ideal for First-Person Shooter (FPS) games.

- 
- Preset Modes**
- **MOBA/RTS:** Loads color settings ideal for Multiplayer Online Battle Arena (MOBA) and Real-Time Strategy (RTS) games.
  - **RPG:** Loads color settings ideal for Role-Playing Games (RPG).
  - **SPORTS:** Loads color settings ideal for sports games.
  - **Game 1/Game 2/Game 3:** Allows you to customize the color settings for your gaming needs.
  - **ComfortView:** Decreases the level of blue light emitted from the screen to make viewing more comfortable for your eyes.

**WARNING: The possible long-term effects of blue light emission from the monitor may cause personal injury such as digital eye strain, eye fatigue and damage to the eyes. Using monitor for extended periods of time may also cause pain in parts of body such as neck, arm, back and shoulder.**

To reduce the risk of eye strain and neck/arm/back/shoulder pain from using the monitor for long periods of time, we suggest you to:

1. Set the distance of the screen between 20 inches to 28 inches (50 cm–70 cm) from your eyes.
  2. Blink frequently to moisten your eyes or wet your eyes with water after prolonged usage of the monitor.
  3. Take regular and frequent breaks for 20 minutes every two hours.
  4. Look away from your monitor and gaze at a distant object at 20 feet away for at least 20 seconds during the breaks.
  5. Perform stretches to relieve tension in the neck, arm, back, and shoulders during the breaks.
- **Warm:** Presents colors at lower color temperatures. The screen appears warmer with a red/yellow tint.
  - **Cool:** Presents colors at higher color temperatures. The screen appears cooler with a blue tint.
  - **Custom Color:** Allows you to manually adjust the color settings. Move the joystick to adjust the **Gain**, **Offset**, **Hue**, and **Saturation** values and create your own preset color mode.
-

---

## Game Enhance Mode

The feature offers three available functions to enhance your gameplay experience.

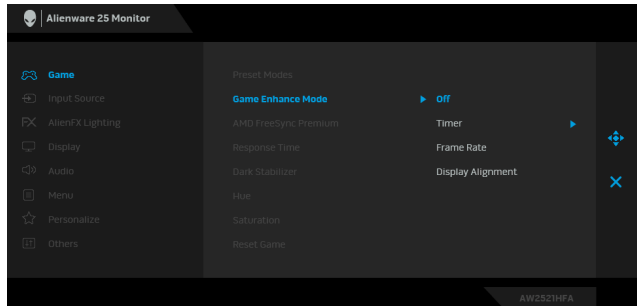

- **Off**

Select to disable the functions under **Game Enhance Mode**.

- **Timer**

Allows you to disable or enable the timer at the upper left corner of the display. The timer shows the time elapsed since the game starts. Select an option from the time-interval list to keep you aware of the remaining time.

- **Frame Rate**

Selecting **On** allows you to display the current frames per second when playing games. The higher the rate, the smoother the motion appears.

- **Display Alignment**

Activate the function to help ensure the perfect alignment of the video contents from multiple displays.

---

## AMD FreeSync Premium

When you select **On**, the monitor runs at the highest frame rate possible to eliminate both input lag and screen tearing, delivering smoother gameplay.

---

## Response Time

Allows you to set the **Response Time** to **Fast**, **Super Fast** or **Extreme**.

---

---

**Dark Stabilizer** The feature improves the visibility in the dark gaming scenarios. The higher the value (between 0 to 3), the better visibility in dark area of the display image.

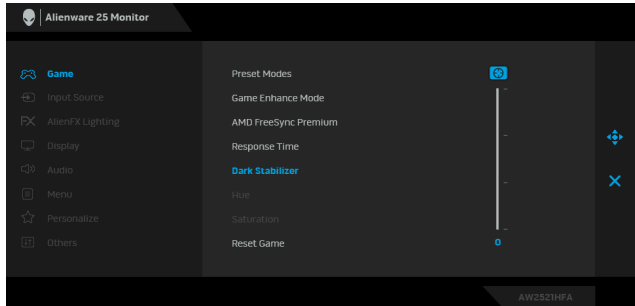

---

**Hue** This feature can shift the color of the video image to green or purple. This is used to adjust the desired flesh-tone color. Use the joystick to adjust the hue level from 0 to 100. Move the joystick up to increase the green shade of the video image. Move the joystick down to increase the purple shade of the video image.

**NOTE:** The **Hue** adjustment is available only when you select **FPS, MOBA/RTS, SPORTS, or RPG** preset mode.

---

**Saturation** This feature can adjust the color saturation of the video image. Use the joystick to adjust the saturation level from 0 to 100. Move the joystick up to increase the colorful appearance of the video image. Move the joystick down to increase the monochrome appearance of the video image.

**NOTE:** The **Saturation** adjustment is available only when you select **FPS, MOBA/RTS, SPORTS, or RPG** preset mode.

---

**Reset Game** Resets all settings under the **Game** menu to the factory defaults.

---



## Input Source

Use the **Input Source** menu to select between the different video signals that may be connected to your monitor.

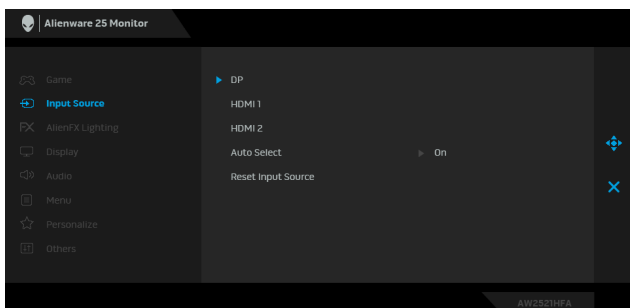

---

**DP** Select the **DP** input when you are using the DisplayPort (DP) connector. Press the joystick button to confirm the selection.

---

**HDMI 1**  
**HDMI 2** Select the **HDMI 1** or **HDMI 2** input when you are using the HDMI connectors. Press the joystick button to confirm the selection.

---

**Auto Select** Turn on the function to allow the monitor to automatically scan for available input sources. Press the joystick button to confirm the selection.

---

**Reset Input Source** Resets all settings under the **Input Source** menu to the factory defaults.

---



## AlienFX Lighting

Use this menu to adjust the LED light settings for the Power button, Alienware logo, and the light stripe on the stand.

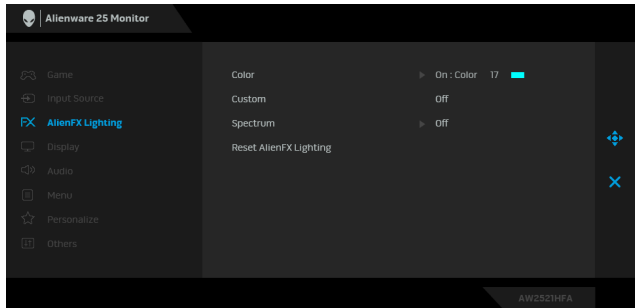

### Color

To specify an LED lighting color, select **On** and move the joystick to highlight the **Custom Color** option.

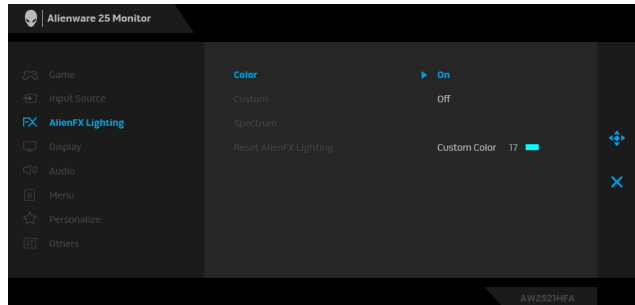

Then you can make a selection from the list of 20 available colors by moving the joystick up or down.

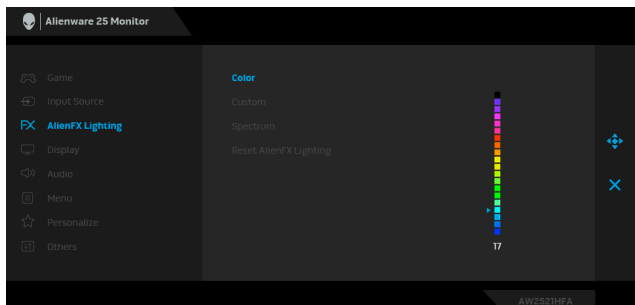



---

The following table depicts the color number and the RGB codes used for the 20 LED colors.

No.	R	G	B
1	0	0	0
2	63	0	255
3	100	0	240
4	255	0	255
5	239	12	175
6	255	0	89
7	255	0	0
8	255	45	0
9	255	75	0
10	255	120	0
11	204	255	0
12	127	255	0
13	76	255	0
14	0	255	0
15	0	255	25
16	0	255	63
17	0	240	240
18	0	63	255
19	0	25	255
20	0	0	255

To turn off the AlienFX lights, select **Off**.

**NOTE:** These functions are only available when **Spectrum** is disabled.

---

**Custom**

It is a read-only menu. When you use **Color** or/and **Spectrum** to make LED lighting adjustments, this menu status shows **Off**; when you make the LED lighting adjustments through AlienFX application, the status changes to **On**.

---

---

## Spectrum

When you select **On**, the LED lighting glows and changes colors in the sequence of the color spectrum: red, orange, yellow, green, blue, indigo, and violet.

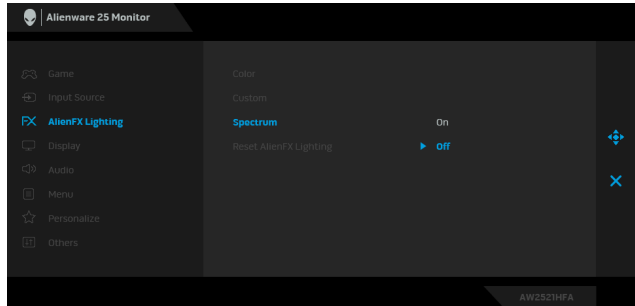

---

## Reset AlienFX Lighting

Resets all settings under the **AlienFX Lighting** menu to the factory defaults.

---

## Display

Use **Display** to adjust images.

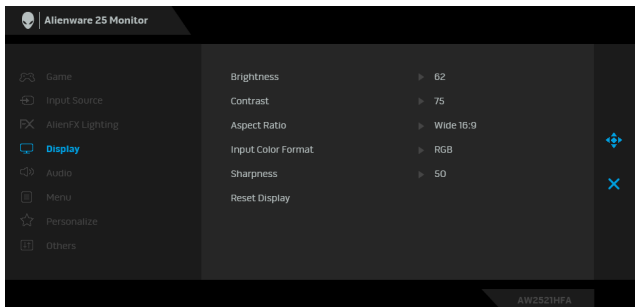

---

## Brightness

**Brightness** adjusts the luminance of the backlight.

Move the joystick up to increase the brightness level or move the joystick down to decrease the brightness level (min. 0 / max. 100).

---

## Contrast

Adjust **Brightness** first, and then adjust **Contrast** only if further adjustment is necessary.

Move the joystick up to increase the contrast level or move the joystick down to decrease the contrast level (min. 0 / max. 100).

The **Contrast** function adjusts the degree of difference between darkness and lightness on the monitor screen.

---

## Aspect Ratio

Adjusts the image ratio to **Wide 16:9**, **Auto Resize**, **4:3**, or **1:1**.

---

---

**Input Color Format**

Allows you to set the video input mode to:

**RGB:** Select this option if your monitor is connected to a computer (or media player) using the DP or HDMI cable.

**YPbPr:** Select this option if your media player supports only YPbPr output.

---

**Sharpness**

This feature can make the image look sharper or softer. Move the joystick to adjust the sharpness level from 0 to 100.

---

**Reset Display**

Resets all settings under the **Display** menu to the factory defaults.

---

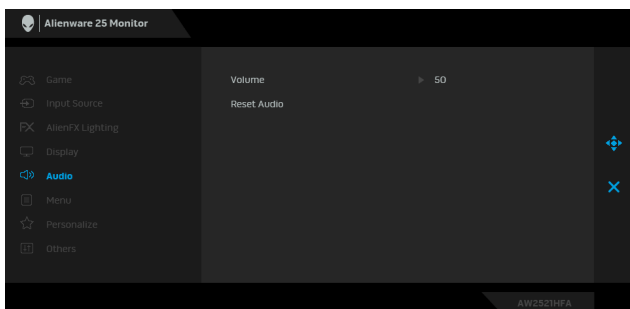
**Audio****Volume**

Allows you to set the volume level of headphone output. Use the joystick to adjust the volume level from 0 to 100.

---

**Reset Audio**

Resets all settings under the **Audio** menu to the factory defaults.

---

**Menu**

Select this option to adjust the settings of the OSD, such as the languages of the OSD, the amount of time the menu remains on screen, and so on.

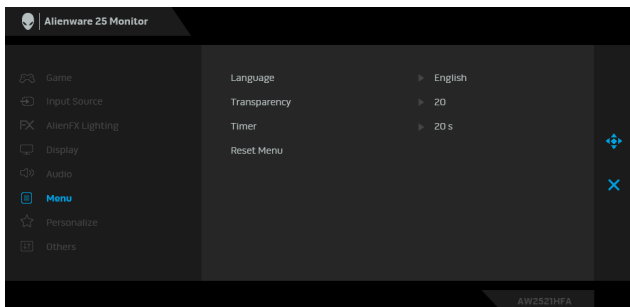
**Language**

Set the OSD display to one of the eight languages (English, Spanish, French, German, Brazilian Portuguese, Russian, Simplified Chinese, or Japanese).

---

---

**Transparency** Select this option to change the menu transparency by moving the joystick up or down (min. 0/max. 100).

**Timer** Sets the length of time for the OSD to remain active after you move the joystick or press a button.  
Move the joystick to adjust the slider in 1 second increments, from 5 to 60 seconds.

**Reset Menu** Resets all settings under the **Menu** menu to the factory defaults.

---



## Personalize

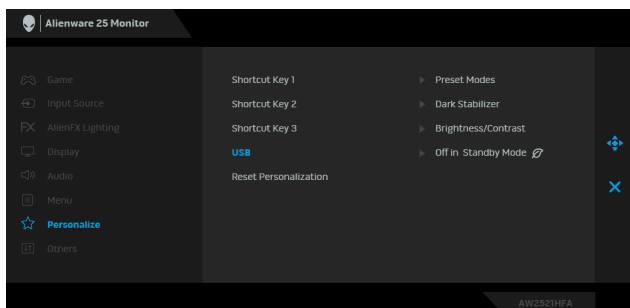

---

**Shortcut Key 1** Allows you to choose a feature from **Preset Modes, Game Enhance Mode, AMD FreeSync Premium, Dark Stabilizer, Brightness/Contrast, Input Source, Aspect Ratio, or Volume** and set it as a shortcut key.

**Shortcut Key 2**

**Shortcut Key 3**

**USB** Allows you to enable or disable USB function during monitor standby mode.

**NOTE:** USB ON/OFF under standby mode is only available when the USB upstream cable is unplugged. This option will be greyed out when the USB upstream cable plugs in.

---

**Reset Personalization** Resets all settings under the **Personalize** menu to the factory defaults.

---



## Others

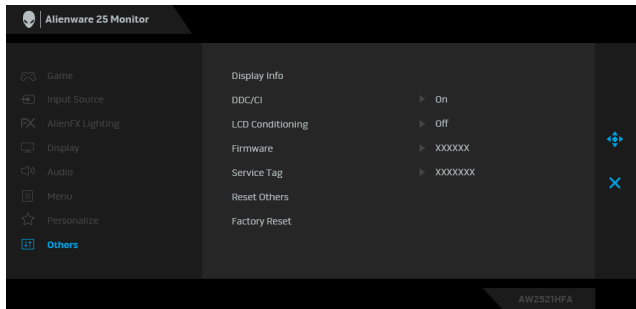

**Display Info** Displays the monitor's current settings.

**DDC/CI** **DDC/CI** (Display Data Channel/Command Interface) allows your monitor parameters (brightness, color balance, and etc.) to be adjustable via the software on your computer.

You can disable this feature by selecting **Off**.

Enable this feature for best user experience and optimum performance of your monitor.

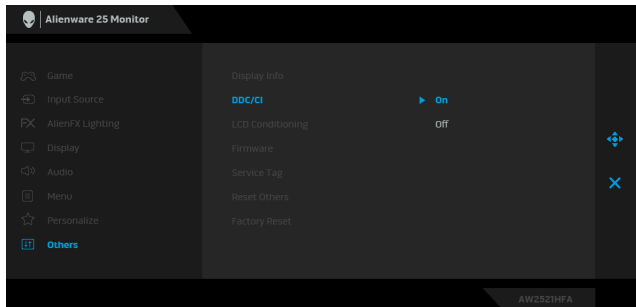

## LCD Conditioning

Helps reduce minor cases of image retention. Depending on the degree of image retention, the program may take some time to run. You can enable this feature by selecting **On**.

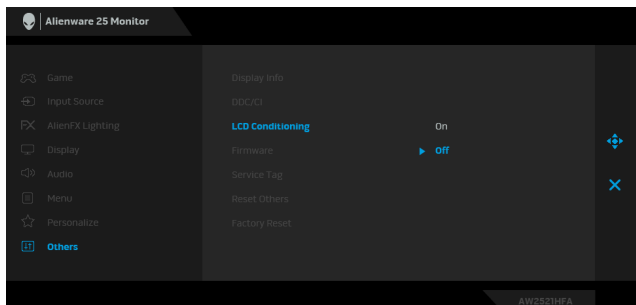

<b>Firmware</b>	Displays the firmware version of your monitor.
<b>Service Tag</b>	Displays the service tag of your monitor. This string is required when you look for phone support, check your warranty status, update drivers on Dell's website, etc.
<b>Reset Others</b>	Resets all settings under the <b>Others</b> menu to the factory defaults.
<b>Factory Reset</b>	Resets all OSD settings to the factory defaults.

## OSD warning message

When the monitor does not support a particular resolution mode, you will see the following message:

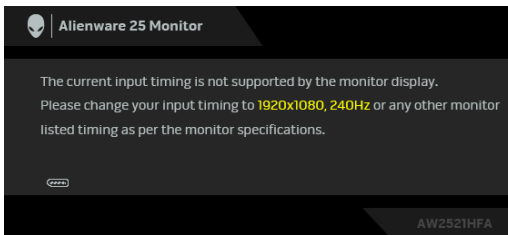

**NOTE:** The message may be slightly different according to the connected input signal.

This means that the monitor cannot synchronize with the signal that it is receiving from the computer. See [Monitor specifications](#) for the Horizontal and Vertical frequency ranges addressable by this monitor. Recommended mode is 1920 x 1080.

You will see the following message before the **DDC/CI** function is disabled:

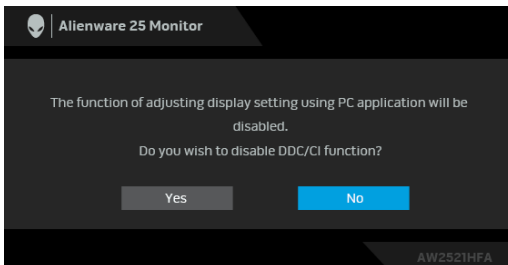

When you adjust the **Brightness** level for the first time, the following message appears:

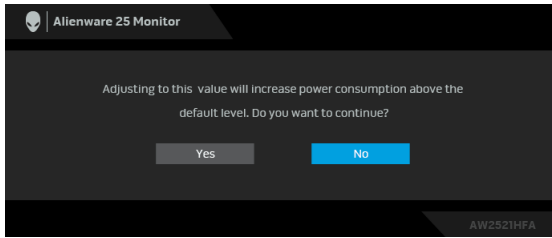

**NOTE:** If you select **Yes**, the message will not appear next time when you intend to change the **Brightness** setting.

When **USB** is set to **On in Standby Mode** for the first time, the following message appears:

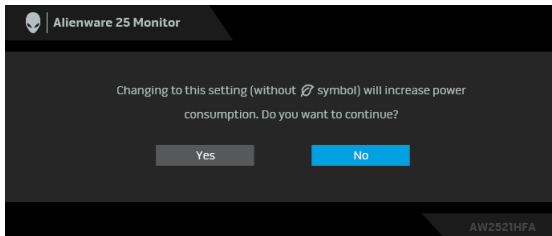

**NOTE:** If you select **Yes**, the message will not appear next time when you intend to change the **USB** setting.

When the monitor goes into Standby mode, the following message appears:

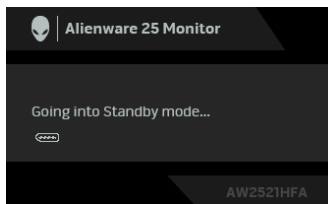

Activate the computer and wake up the monitor to gain access to the **Using the On-Screen Display (OSD) menu**.

**NOTE:** The message may be slightly different according to the connected input signal.

If you press any button other than the power button, the following message will appear depending on the selected input:

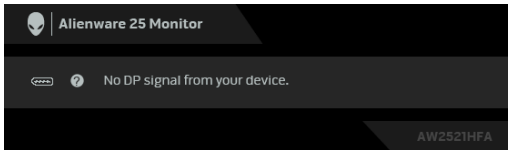

**NOTE:** The message may be slightly different according to the connected input signal.

If either HDMI or DP input is selected and the corresponding cable is not connected, a floating dialog box as shown below appears.

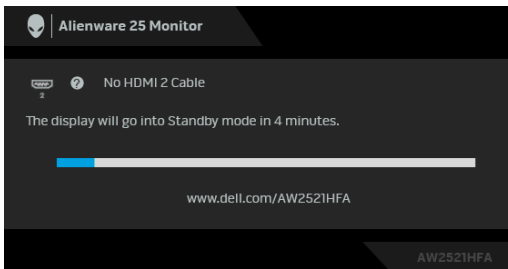

**NOTE:** The message may be slightly different according to the connected input signal.

When **Factory Reset** is selected, the following message appears:

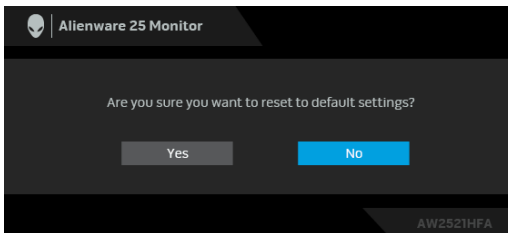

See [Troubleshooting](#) for more information.



## Locking the rear-panel control buttons

You can lock the rear-panel control buttons to prevent access to the OSD menu and/or power button.

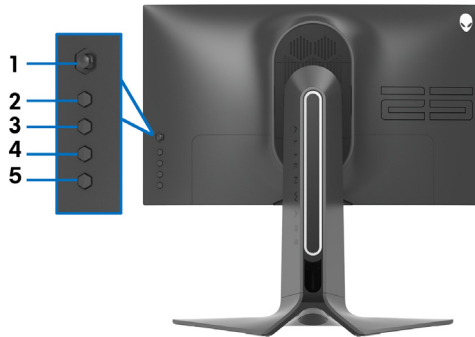

To lock the button(s):

1. Press and hold **Button 5** for four seconds, a menu appears on the screen.
2. Select one of the following options:
  - **Menu Buttons:** Choose this option to lock all OSD menu buttons except the Power button.
  - **Power Button:** Choose this option to lock only the Power button.
  - **Menu + Power Buttons:** Choose this option to lock all the buttons on the rear-panel control.

To unlock the button(s), press and hold **Button 5** for four seconds until a menu appears on the screen. Select the **Unlock icon**  to unlock the button(s).

## Setting the maximum resolution

To set the maximum resolution for the monitor:

In Windows 7, Windows 8, and Windows 8.1:

1. For Windows 8 and Windows 8.1 only, select the Desktop tile to switch to classic desktop.
2. Right-click on the desktop and click **Screen Resolution**.
3. Click the Dropdown list of the Screen Resolution and select **1920 x 1080**.
4. Click **OK**.

In Windows 10:

1. Right-click on the desktop and click **Display settings**.
2. Click **Advanced display settings**.
3. Click the dropdown list of **Resolution** and select **1920 x 1080**.
4. Click **Apply**.

If you do not see 1920 x 1080 as an option, you may need to update your graphics driver. Depending on your computer, complete one of the following procedures:

If you have a Dell desktop or a laptop:

- Go to **[www.dell.com/support](http://www.dell.com/support)**, enter your service tag, and download the latest driver for your graphics card.

If you are using a non-Dell computer (laptop or desktop):

- Go to the support site for your computer and download the latest graphic drivers.
- Go to your graphics card website and download the latest graphic drivers.

## Using the tilt, swivel, and vertical extension

**NOTE:** The following instructions are applicable only for attaching the stand that was shipped with your monitor. If you are attaching a stand that you purchased from any other source, follow the set up instructions that were included with the stand.

### Tilt and swivel extensions

With the stand attached to the monitor, you can tilt and swivel the monitor for the most comfortable viewing angle.

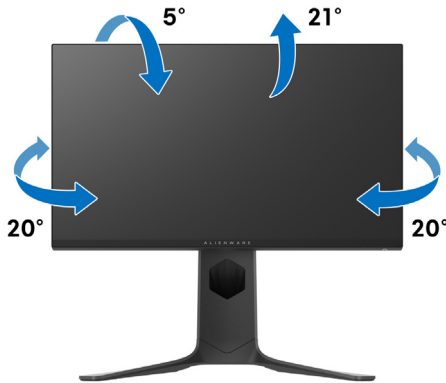

**NOTE:** The stand is not factory-installed.

### Vertical extension

**NOTE:** The stand extends vertically up to 130 mm. The figure below illustrates how to extend the stand vertically.

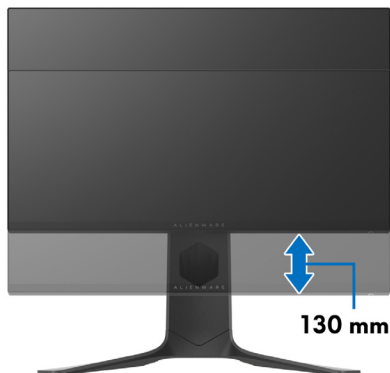

## Rotating the monitor

Before you rotate the monitor, your monitor should be fully extended vertically (vertical extension) and fully tilted up to avoid hitting the bottom edge of the monitor.



## Rotate clockwise

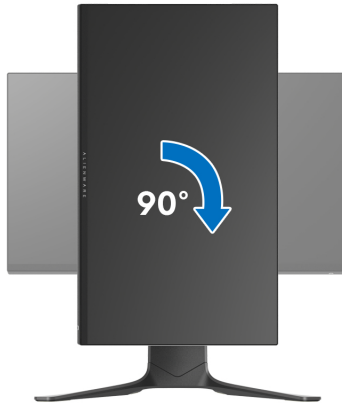

## Rotate counterclockwise

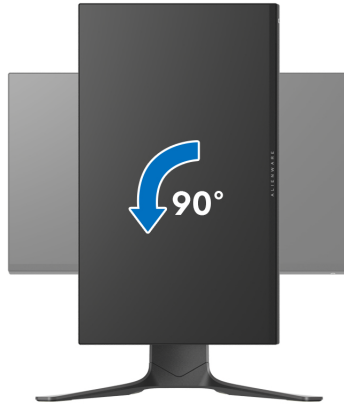

- NOTE: To use the Display Rotation function (Landscape versus Portrait view) with your Dell computer, you require an updated graphics driver that is not included with this monitor. To download the graphics driver, go to [www.dell.com/support](http://www.dell.com/support) and see the Download section for Video Drivers for latest driver updates.
- NOTE: When in the Portrait View Mode, you may experience performance degradation in graphic-intensive applications (3D Gaming and etc.).

## Adjusting the rotation display settings of your system

After you have rotated your monitor, you need to complete the procedure below to adjust the Rotation Display Settings of your system.

 **NOTE: If you are using the monitor with a non-Dell computer, you need to go the graphics driver website or your computer manufacturer website for information on rotating the 'contents' on your display.**

To adjust the Rotation Display Settings:

1. Right-click on the desktop and click **Properties**.
2. Select the **Settings** tab and click **Advanced**.
3. If you have an ATI graphics card, select the **Rotation** tab and set the preferred rotation.
4. If you have an NVIDIA® graphics card, click the **NVIDIA** tab, in the left-hand column select **NVRotate**, and then select the preferred rotation.
5. If you have an Intel® graphics card, select the **Intel** graphics tab, click **Graphic Properties**, select the **Rotation** tab, and then set the preferred rotation.

 **NOTE: If you do not see the rotation option or it is not working correctly, go to [www.dell.com/support](http://www.dell.com/support) and download the latest driver for your graphics card.**

# Using AlienFX application

You can configure the LED lighting effects across multiple distinct zones on your Alienware monitor through AlienFX in AWCC (Alienware Command Center).

 **NOTE: If you have an Alienware Gaming Desktop or Laptop, you can directly access AWCC to control the lightings.**

 **NOTE: For more information, see Alienware Command Center Online Help.**

## Prerequisites

Before installing the AWCC on a non-Alienware system:

- Ensure the OS of your computer is Windows 10 R3 or later.
- Ensure your internet connection is active.
- Ensure that the supplied USB cable is connected to both the Alienware monitor and the computer.

## Installing AWCC through Windows update

1. The AWCC application is downloaded and will be automatically installed. The installation takes a few minutes to complete.
2. Navigate to the program folder to ensure that the installation is successful. Alternatively, you can find the AWCC application in the **Start** menu.
3. Launch AWCC and perform the following steps to download the additional software components:
  - In the **Settings** window, click **Windows Update**, and then click **Check for updates** to check the Alienware driver update progress.
  - If the driver update is not responding in your computer, install AWCC from the Dell Support website.

## Installing AWCC from the Dell Support website

1. Enter AW2521HFA or AW2521HFLA in the query field at [www.dell.com/support/drivers](http://www.dell.com/support/drivers), and download the latest version of the following items:
  - Alienware Command Center Application
  - Alienware Gaming Monitor Control Center Driver
2. Navigate to the folder in which you saved the setup files.
3. Double-click the setup file and follow the on-screen instructions to complete the installation.

## Navigating the AlienFX window

With the Alienware Command Center, AlienFX allows you to control the LED lighting colors and transition effects for your Alienware monitor.

In the AWCC home screen, click **FX** in the top menu bar to access the home screen of AlienFX.

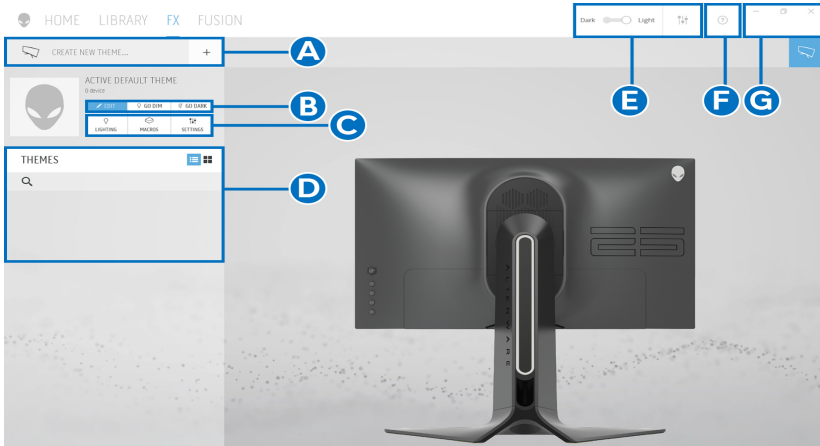

The following table describes the functions and features on the home screen:

No.	Functions	Descriptions
<b>A</b>	<b>CREATE NEW THEME...</b>	Click <b>+</b> and then enter a name in the text box to add a theme.
<b>B</b>	Edit controls	<ul style="list-style-type: none"> <li>• <b>EDIT:</b> Provides options for you to customize lighting settings for your theme.</li> <li>• <b>GO DIM:</b> Makes the light dimmer.</li> <li>• <b>GO DARK:</b> Turns off the light.</li> </ul>
<b>C</b>	Theme components	You can use these components ( <b>LIGHTING, MACROS, SETTINGS</b> ) to make the selected theme as an active master theme.
<b>D</b>	<b>THEMES</b> list	Displays the themes in list view or grid view.
<b>E</b>	Background controls	Adjusts the background animation effects.
<b>F</b>	Help	Click it to access the AWCC Online Help.
<b>G</b>	Window controls	You can use the buttons to minimize, maximize, or restore the size of the window. When <b>×</b> is selected, the application will close.



When you start to customize a theme, you should see the following screen:

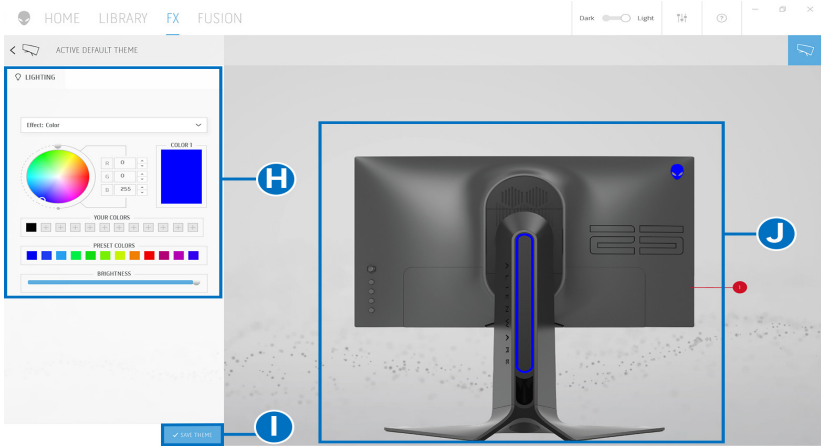

The following table describes the functions and features on the screen:

No.	Functions	Descriptions
H	<b>LIGHTING</b> panel	Use the controls in this panel to set up lighting effects for a theme. See <a href="#">Setting lighting effects</a> for details.
I	<b>SAVE THEME</b>	Click to save all adjustments and changes for the theme.
J	Live preview	The lighting zones are with numbered callouts. You may select a single zone by clicking the number on the image. When you make lighting adjustments, the preview of the monitor displays the new effects simultaneously.

## Creating a theme

To create a theme with your preferred lighting settings:

1. Launch AWCC.
2. Click **FX** in the top menu bar to access the home screen of AlienFX.
3. In the top-left corner of the window, click  to create a new theme.
4. In the **CREATE NEW THEME** text box, type the theme name.
5. Specify the lighting zone(s) for which you want to make lighting adjustments by:
  - selecting the zone check box(es) above the live preview area, or
  - clicking the numbered callout on the image of monitor
6. In the **LIGHTING** panel, select your preferred lighting effects from the drop-down list, including **Morph**, **Pulse**, **Color**, **Spectrum**, and **Breathing**. See [Setting lighting effects](#) for details.

 **NOTE: The Spectrum option is only available when you select All Zones to make lighting adjustments.**

7. Repeat step 5 and step 6 to make more configuration options available to your preference.
8. When done, click **SAVE THEME**. A toast notification appears in the right-bottom corner of the screen.

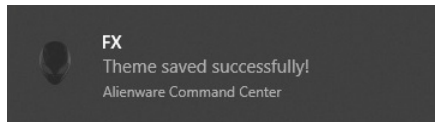

## Setting lighting effects

The **LIGHTING** panel provides various lighting effects. You may click **Effect** to open a drop-down menu with available options.

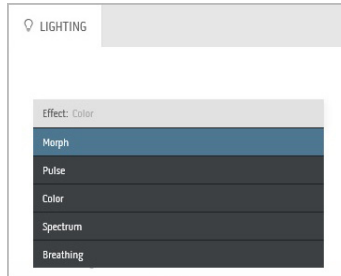

**NOTE:** The options displayed may vary depending on the lighting zone(s) you specified.

The following table provides an overview of different options:

Morph	Descriptions
	<p>The effect changes the light color into another through a seamless transition.</p> <p>To make the adjustments:</p> <ol style="list-style-type: none"> <li>1. Pick a preferred color from the color palette or the list of <b>PRESET COLORS</b>. The selected color and its RGB color codes will be displayed on the right field.</li> </ol> <p><b>NOTE:</b> To change the color, use the up and down arrow buttons beside the R/G/B boxes to edit the color codes.</p> <ol style="list-style-type: none"> <li>2. To add the selected color to the list of <b>YOUR COLORS</b> for quick access in the future, click . At most 12 colors can be added to the list.</li> <li>3. Repeat the previous steps to specify <b>Color 2</b> to be the ending light color.</li> <li>4. Drag the <b>BRIGHTNESS</b> slider to adjust the lightness of the color.</li> <li>5. Drag the <b>TEMPO</b> slider to adjust the transition speed.</li> </ol>

## Pulse

## Descriptions

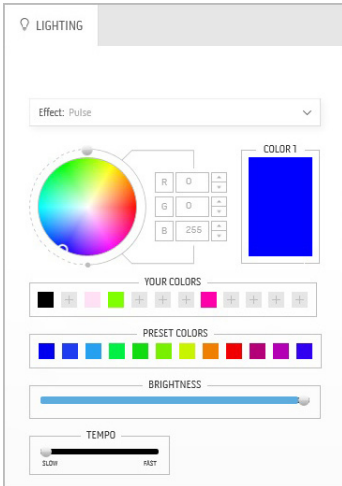

The effect makes the light flash with a short pause.  
To make the adjustments:

1. Pick a preferred color from the color palette or the list of **PRESET COLORS**. The selected color and its RGB color codes will be displayed on the right field.

**NOTE:** To change the color, use the up and down arrow buttons beside the R/G/B boxes to edit the color codes.

2. To add the selected color to the list of **YOUR COLORS** for quick access in the future, click . At most 12 colors can be added to the list.

**NOTE:** To remove an existing color chip from the list, right-click on it.

3. Drag the **BRIGHTNESS** slider to adjust the lightness of the color.
4. Drag the **TEMPO** slider to adjust the pulsing speed.

## Color

## Descriptions

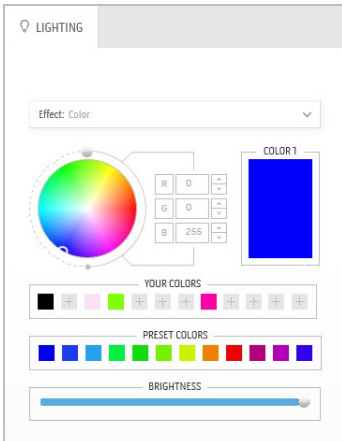

The effect makes the LED light in a single static color.

To make the adjustments:

1. Pick a preferred color from the color palette or the list of **PRESET COLORS**. The selected color and its RGB color codes will be displayed on the right field.

**NOTE:** To change the color, use the up and down arrow buttons beside the R/G/B boxes to edit the color codes.

2. To add the selected color to the list of **YOUR COLORS** for quick access in the future, click . At most 12 colors can be added to the list.

**NOTE:** To remove an existing color chip from the list, right-click on it.

3. Drag the **BRIGHTNESS** slider to adjust the lightness of the color.

---

## Spectrum

## Descriptions

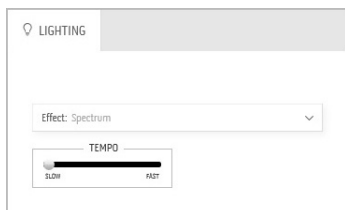

The effect makes the light change in sequence of spectrum: red, orange, yellow, green, blue, indigo, and violet.

You can drag the **TEMPO** slider to adjust the transition speed.

**NOTE:** The option is available only when you select **All Zones** to make lighting adjustments.

---

## Breathing

## Descriptions

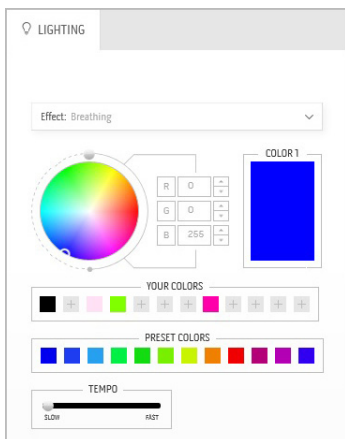

The effect makes the light change from bright to dim.

To make the adjustments:

1. Pick a preferred color from the color palette or the list of **PRESET COLORS**. The selected color and its RGB color codes will be displayed on the right field.

**NOTE:** To change the color, use the up and down arrow buttons beside the R/G/B boxes to edit the color codes.

2. To add the selected color to the list of **YOUR COLORS** for quick access in the future, click . At most 12 colors can be added to the list.
  3. Drag the **TEMPO** slider to adjust the transition speed.
-

# Troubleshooting

**⚠ WARNING:** Before you begin any of the procedures in this section, follow the [Safety instructions](#).

## Self-test

Your monitor provides a self-test feature that allows you to check whether your monitor is functioning properly. If your monitor and computer are properly connected but the monitor screen remains dark, run the monitor self-test by performing the following steps:

1. Turn off both your computer and the monitor.
2. Unplug the video cable from the back of the computer. To ensure proper Self-Test operation, remove all digital cables from the back of computer.
3. Turn on the monitor.

**✍ NOTE:** A dialog box should appear on-screen (against a black background), if the monitor cannot sense a video signal and is working correctly. While in self-test mode, the power LED blinks blue (default color).

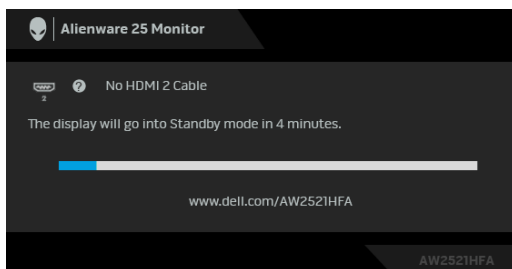

**✍ NOTE:** This box also appears during normal system operation, if the video cable is disconnected or damaged.

4. Turn off your monitor and reconnect the video cable; then turn on both your computer and the monitor.

If your monitor screen remains blank after you use the previous procedure, check your video controller and computer, because your monitor is functioning properly.

## Built-in diagnostics

Your monitor has a built-in diagnostic tool that helps you determine if the screen abnormality you are experiencing is an inherent problem with your monitor, or with your computer and video card.

 **NOTE: You can run the built-in diagnostics only when the video cable is unplugged and the monitor is in self-test mode.**

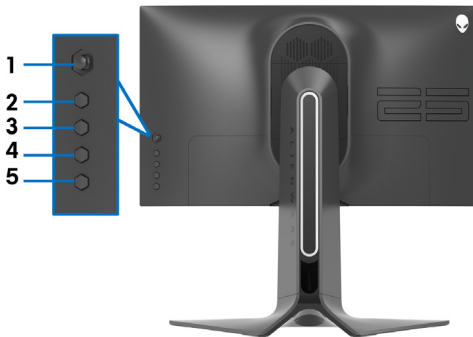

To run the built-in diagnostics:

1. Ensure that the screen is clean (no dust particles on the surface of the screen).
2. Press and hold **Button 5** for four seconds until a menu appears on the screen.
3. Using the joystick control, highlight the **Diagnostics**  option and press the joystick button to start the diagnostics. A grey screen is displayed.
4. Observe if the screen has any defects or abnormalities.
5. Toggle the joystick once again until a red screen is displayed.
6. Observe if the screen has any defects or abnormalities.
7. Repeat steps 5 and 6 until the screen displays green, blue, black, and white colors. Note any abnormalities or defects.

The test is complete when a text screen is displayed. To exit, toggle the joystick control again.

If you do not detect any screen abnormalities upon using the built-in diagnostic tool, the monitor is functioning properly. Check the video card and computer.

## Common problems

The following table contains general information about common monitor problems you might encounter and the possible solutions:

Common symptoms	What you experience	Possible solutions
No Video/ Power LED off	No picture	<ul style="list-style-type: none"><li>Ensure that the video cable connecting the monitor and the computer is properly connected and secure.</li><li>Verify that the power outlet is functioning properly using any other electrical equipment.</li><li>Ensure that the power button is depressed fully.</li><li>Ensure that the correct input source is selected in the <b>Input Source</b> menu.</li></ul>
No Video/ Power LED on	No picture or no brightness	<ul style="list-style-type: none"><li>Increase brightness and contrast controls in the <b>Display</b> menu.</li><li>Perform monitor self-test feature check.</li><li>Check for bent or broken pins in the video cable connector.</li><li>Run the built-in diagnostics.</li><li>Ensure that the correct input source is selected in the <b>Input Source</b> menu.</li></ul>
Poor Focus	Picture is fuzzy, blurry, or ghosting	<ul style="list-style-type: none"><li>Eliminate video extension cables.</li><li>Reset the monitor to factory settings.</li><li>Change the video resolution to the correct aspect ratio.</li></ul>
Shaky/Jittery Video	Wavy picture or fine movement	<ul style="list-style-type: none"><li>Reset the monitor to factory settings.</li><li>Check environmental factors.</li><li>Relocate the monitor and test in another room.</li></ul>
Missing Pixels	LCD screen has spots	<ul style="list-style-type: none"><li>Cycle power On-Off.</li><li>Pixel that is permanently off is a natural defect that can occur in LCD technology.</li><li>For more information on Dell Monitor Quality and Pixel Policy, see Dell support site: <a href="http://www.dell.com/pixelguidelines">www.dell.com/pixelguidelines</a>.</li></ul>
Stuck-on Pixels	LCD screen has bright spots	<ul style="list-style-type: none"><li>Cycle power On-Off.</li><li>Pixel that is permanently off is a natural defect that can occur in LCD technology.</li><li>For more information on Dell Monitor Quality and Pixel Policy, see Dell support site: <a href="http://www.dell.com/pixelguidelines">www.dell.com/pixelguidelines</a>.</li></ul>



Brightness Problems	Picture too dim or too bright	<ul style="list-style-type: none"> <li>Reset the monitor to factory settings.</li> <li>Adjust brightness and contrast controls in the <b>Display</b> menu.</li> </ul>
Geometric Distortion	Screen not centered correctly	<ul style="list-style-type: none"> <li>Reset the monitor to factory settings.</li> </ul>
Horizontal/Vertical Lines	Screen has one or more lines	<ul style="list-style-type: none"> <li>Reset the monitor to factory settings.</li> <li>Perform monitor self-test feature check and determine if these lines are also in self-test mode.</li> <li>Check for bent or broken pins in the video cable connector.</li> <li>Run the built-in diagnostics.</li> </ul>
Synchronization Problems	Screen is scrambled or appears torn	<ul style="list-style-type: none"> <li>Reset the monitor to factory settings.</li> <li>Perform monitor self-test feature check to determine if the scrambled screen appears in self-test mode.</li> <li>Check for bent or broken pins in the video cable connector.</li> <li>Restart the computer in the <i>safe mode</i>.</li> </ul>
Safety Related Issues	Visible signs of smoke or sparks	<ul style="list-style-type: none"> <li>Do not perform any troubleshooting steps.</li> <li><b>Contact Dell</b> immediately.</li> </ul>
Intermittent Problems	Monitor malfunctions on & off	<ul style="list-style-type: none"> <li>Ensure that the video cable connecting the monitor to the computer is connected properly and is secure.</li> <li>Reset the monitor to factory settings.</li> <li>Perform monitor self-test feature check to determine if the intermittent problem occurs in self-test mode.</li> </ul>
Missing Color	Picture missing color	<ul style="list-style-type: none"> <li>Perform monitor self-test feature check.</li> <li>Ensure that the video cable connecting the monitor to the computer is connected properly and is secure.</li> <li>Check for bent or broken pins in the video cable connector.</li> </ul>

Wrong Color	Picture color not good	<ul style="list-style-type: none"> <li>Change the settings of the <b>Preset Modes</b> in the <b>Game</b> menu OSD depending on the application.</li> <li>Adjust <b>Gain/Offset/Hue/Saturation</b> value under <b>Custom Color</b> in the <b>Game</b> menu OSD.</li> <li>Run the built-in diagnostics.</li> </ul>
Image retention from a static image left on the monitor for a long period of time	Faint shadow from the static image displayed appears on the screen	<ul style="list-style-type: none"> <li>Use the Power Management feature to turn off the monitor at all times when not in use (for more information, see <a href="#">Power management modes</a>).</li> <li>Alternatively, use a dynamically changing screensaver.</li> </ul>

## Product specific problems

Specific symptoms	What you experience	Possible solutions
Screen image is too small	Image is centered on screen, but does not fill entire viewing area	<ul style="list-style-type: none"> <li>Reset the monitor to factory settings.</li> </ul>
Cannot adjust the monitor with the buttons on the rear panel	OSD does not appear on the screen	<ul style="list-style-type: none"> <li>Turn off the monitor, unplug the power cord, plug it back, and then turn on the monitor.</li> <li>The OSD menu may be locked. Press and hold the fourth button (the <b>Brightness/Contrast</b> shortcut key by default) below the joystick button for 4 seconds to unlock.</li> </ul>
No Input Signal when user controls are pressed	No picture, the LED light is blue	<ul style="list-style-type: none"> <li>Check the signal source. Ensure the computer is not in the power saving mode by moving the mouse or pressing any key on the keyboard.</li> <li>Check whether the signal cable is plugged in properly. Re-plug the signal cable if necessary.</li> <li>Reset the computer or video player.</li> </ul>
The picture does not fill the entire screen	The picture cannot fill the height or width of the screen	<ul style="list-style-type: none"> <li>Due to different video formats (aspect ratio), the monitor may display in full screen.</li> <li>Run the built-in diagnostics.</li> </ul>

## Universal Serial Bus (USB) specific problems

Specific symptoms	What you experience	Possible solutions
USB interface is not working	USB peripherals are not working	<ul style="list-style-type: none"><li>▪ Check that your monitor is turned on.</li><li>▪ Reconnect the upstream cable to your computer.</li><li>▪ Reconnect the USB peripherals (downstream connector).</li><li>▪ Switch off and then turn on the monitor again.</li><li>▪ Reboot the computer.</li><li>▪ Some USB devices like external portable HDD require higher electric current; connect the device directly to the computer system.</li></ul>
Super Speed USB 3.0 interface is slow	Super Speed USB 3.0 peripherals working slowly or not working at all	<ul style="list-style-type: none"><li>▪ Check that your computer is USB 3.0-capable.</li><li>▪ Some computers have USB 3.0, USB 2.0, and USB 1.1 ports. Ensure that the correct USB port is used.</li><li>▪ Reconnect the upstream cable to your computer.</li><li>▪ Reconnect the USB peripherals (downstream connector).</li><li>▪ Reboot the computer.</li></ul>
Wireless USB peripherals stop working when a USB 3.0 device is plugged in	Wireless USB peripherals responding slowly or only working as the distance between itself and its receiver decreases	<ul style="list-style-type: none"><li>▪ Increase the distance between the USB 3.0 peripherals and the wireless USB receiver.</li><li>▪ Position your wireless USB receiver as close as possible to the wireless USB peripherals.</li><li>▪ Use a USB-extender cable to position the wireless USB receiver as far away as possible from the USB 3.0 port.</li></ul>

# Appendix

## **WARNING: Safety instructions**

 **WARNING: Use of controls, adjustments, or procedures other than those specified in this documentation may result in exposure to shock, electrical hazards, and/or mechanical hazards.**

For information on safety instructions, see the Safety, Environmental, and Regulatory Information (SERI).

## **FCC notices (U.S. only) and other regulatory information**

For FCC notices and other regulatory information, see the regulatory compliance website located at [www.dell.com/regulatory\\_compliance](http://www.dell.com/regulatory_compliance).

## **Contact Dell**

**For customers in the United States, call 800-WWW-DELL (800-999-3355).**

 **NOTE: If you do not have an active Internet connection, you can find contact information on your purchase invoice, packing slip, bill, or Dell product catalog.**

**Dell provides several online and telephone-based support and service options. Availability varies by country and product, and some services may not be available in your area.**

- Online technical assistance: [www.dell.com/support/monitors](http://www.dell.com/support/monitors)
- Contacting Dell: [www.dell.com/contactdell](http://www.dell.com/contactdell)