



EW Series  
LCD Monitor  
User Manual



## Copyright

Copyright © 2013 by BenQ Corporation. All rights reserved. No part of this publication may be reproduced, transmitted, transcribed, stored in a retrieval system or translated into any language or computer language, in any form or by any means, electronic, mechanical, magnetic, optical, chemical, manual or otherwise, without the prior written permission of BenQ Corporation.

## Disclaimer

BenQ Corporation makes no representations or warranties, either expressed or implied, with respect to the contents hereof and specifically disclaims any warranties, merchantability or fitness for any particular purpose. Further, BenQ Corporation reserves the right to revise this publication and to make changes from time to time in the contents hereof without obligation of BenQ Corporation to notify any person of such revision or changes.

The performance of flicker-free may be affected by external factors such as poor cable quality, unstable power supply, signal interference, or poor grounding, and not limited to the above mentioned external factors. (Applicable for flicker-free models only.)

## Power Safety



Please follow these safety instructions for best performance, and long life for your monitor.

---

- The AC plug isolates this equipment from the AC supply.
- The power supply cord serves as a power disconnect device for pluggable equipment. The socket outlet should be installed near the equipment and be easily accessible.
- This product should be operated from the type of power indicated on the marked label. If you are not sure of the type of power available, consult your dealer or local power company.
- An approved power cord greater or equal to H03VV-F or H05VV-F, 2G or 3G, 0.75mm<sup>2</sup> must be used.
- For EW2740L/EW2740LE, the power adapter is manufactured by Asian Power Devices (DA-50F19).  
For EW2440L/EW2440LE, the power adapter is manufactured by Asian Power Devices (DA-40C19-ACAB) or Atech (A040219-T61).
- Use only the power adapter supplied with your LCD Monitor. Use of another type of power adapter will result in malfunction and/or danger.
- Allow adequate ventilation around the adapter when using it to operate the device or charge the battery. Do not cover the power adapter with paper or other objects that will reduce cooling. Do not use the power adapter while it is inside a carrying case.
- Connect the power adapter to a proper power source.
- Do not attempt to service the power adapter. There are no service parts inside. Replace the unit if it is damaged or exposed to excess moisture.

## Care And Cleaning

- **Cleaning.** Always unplug your monitor from the wall outlet before cleaning. Clean the LCD monitor surface with a lint-free, non-abrasive cloth. Avoid using any liquid, aerosol or glass cleaners.
- Slots and openings on the back or top of the cabinet are for ventilation. They must not be blocked or covered. Your monitor should never be placed near or over a radiator or heat source, or in a built-in installation unless proper ventilation is provided.
- Never push objects or spill liquid of any kind into this product.

## Servicing

Do not attempt to service this product yourself, as opening or removing covers may expose you to dangerous voltages or other risks. If any of the above mentioned misuse or other accident such as dropping or mishandling occurs, contact qualified service personnel for servicing.

## BenQ ecoFACTS

BenQ has been dedicated to the design and development of greener product as part of its aspiration to realize the ideal of the "Bringing Enjoyment 'N Quality to Life" corporate vision with the ultimate goal to achieve a low-carbon society. Besides meeting international regulatory requirement and standards pertaining to environmental management, BenQ has spared no efforts in pushing our initiatives further to incorporate life cycle design in the aspects of material selection, manufacturing, packaging, transportation, using and disposal of the products. BenQ ecoFACTS label lists key eco-friendly design highlights of each product, hoping to ensure that consumers make informed green choices at purchase. Check out BenQ's CSR Website at <http://csr.BenQ.com/> for more details on BenQ's environmental commitments and achievements.







# Table of Contents

Copyright .....	2
Getting started .....	5
Getting to know your monitor .....	7
Front view.....	7
Back view .....	7
Connection .....	8
How to assemble your monitor hardware .....	9
How to use the phone holder .....	14
How to detach the stand and the base .....	15
Getting the most from your BenQ monitor .....	16
How to install the monitor on a new computer .....	17
How to upgrade the monitor on an existing computer .....	18
How to install on Windows 8 system .....	19
How to install on Windows 7 system .....	20
How to adjust your monitor .....	21
The control panel.....	21
Basic menu operation .....	22
Picture optimization .....	24
Customizing the hot keys.....	24
Adjusting display mode .....	24
Choosing an appropriate picture mode.....	25
Connecting the monitor to your MacBook series product .....	25
Navigating the main menu .....	26
Display menu .....	27
Picture menu .....	29
Picture Advanced menu .....	31
Audio menu .....	34
System menu .....	35
Troubleshooting .....	38
Frequently asked questions (FAQ) .....	38
Need more help?.....	40

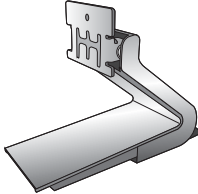
# Getting started

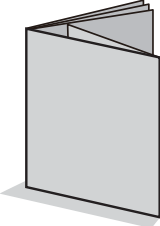
When unpacking please check you have the following items. If any are missing or damaged, please contact the place of purchase for a replacement.

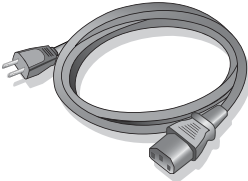
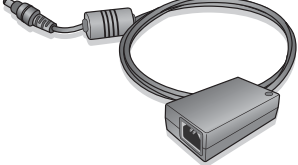
BenQ LCD Monitor	
Monitor Stand	
Monitor Base	
Quick Start Guide	
CD-ROM	
Power Cord (Picture may differ from product supplied for your region.)	
Power Adapter	

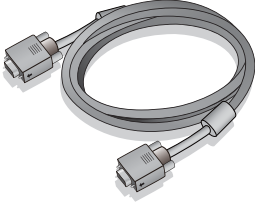
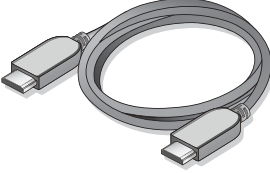
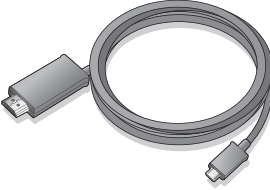
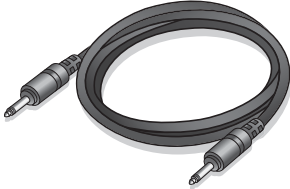
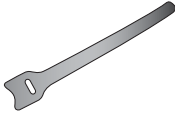
Video Cable: D-Sub	
Video Cable: HDMI (Optional accessory, sold separately)	
Video Cable: MHL	
Audio Cable (Optional accessory, sold separately)	
Cable strap	



- Available accessories and the pictures shown here may differ from the actual contents and the product supplied for your region. For cables that are not supplied with your product, you can purchase them separately.
- Consider keeping the box and packaging in storage for use in the future when you may need to transport the monitor. The fitted foam packing is ideal for protecting the monitor during transport.



Always keep the product and accessories out of reach of small children.

# Getting to know your monitor

## Front view

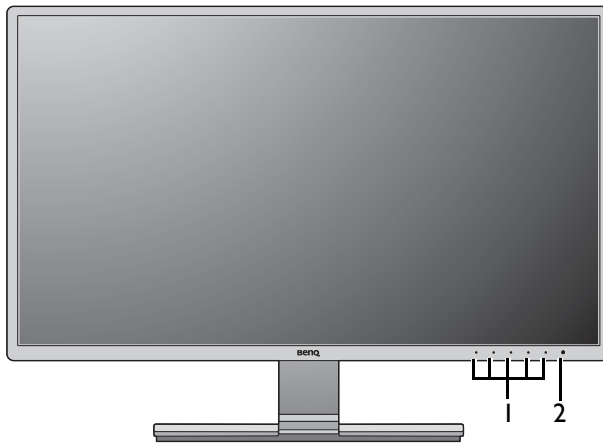

1. Control buttons
2. Power button

## Back view

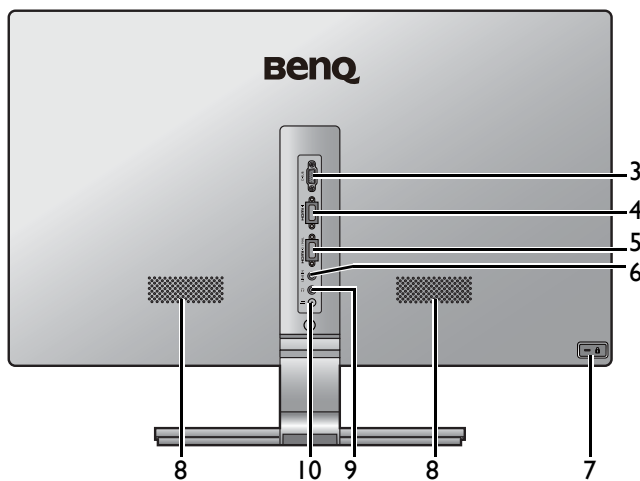

3. D-Sub socket
4. HDMI socket
5. HDMI / MHL socket
6. Audio Line In
7. Kensington lock slot
8. Speakers
9. Headphone jack
10. DC power input jack



- Above diagram may vary depending on the model.
- Picture may differ from product supplied for your region.

## Connection

The following connection illustrations are for your reference only. For cables that are not supplied with your product, you can purchase them separately.

For detailed connection methods, see page [11](#) - [12](#).

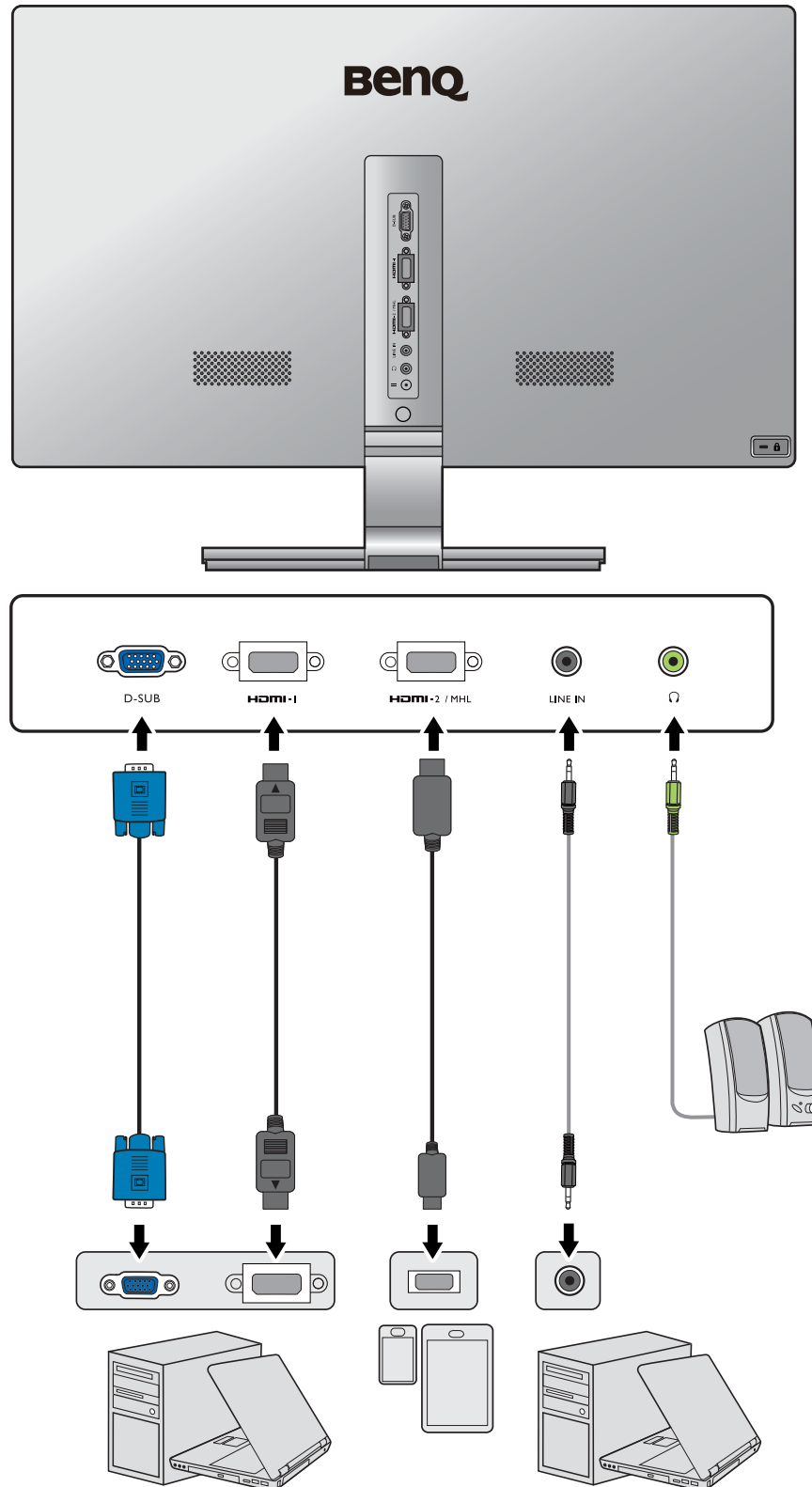



# How to assemble your monitor hardware



If the computer is turned on you must turn it off before continuing.  
Do not plug-in or turn-on the power to the monitor until instructed to do so.

## I. Attach the monitor base.



Please be careful to prevent damage to the monitor. Placing the screen surface on an object like a stapler or a mouse will crack the glass or damage the LCD substrate voiding your warranty. Sliding or scraping the monitor around on your desk will scratch or damage the monitor surround and controls.

Protect the monitor and screen by clearing a flat open area on your desk and placing a soft item like the monitor packaging bag on the desk for padding.

Gently lay the screen face down on a flat clean padded surface.



Attach the monitor stand to the monitor base as illustrated until it locks in place.

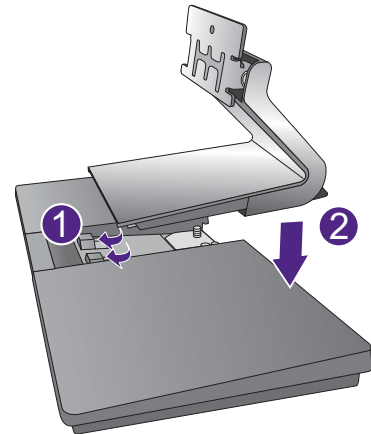

Tighten the screw on the bottom of the monitor base as illustrated.



To secure or release a screw, a screwdriver or a coin is required.

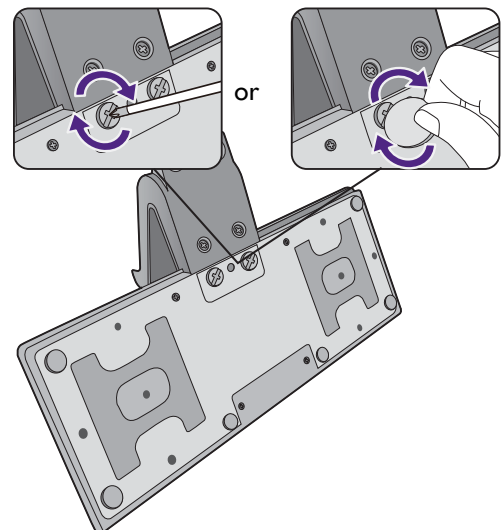

Orient and align the stand arm with the monitor, then push them together until they click and lock into place.

Tighten the screw that fixes the stand to the monitor.



To secure or release a screw, a screwdriver or a coin is required.

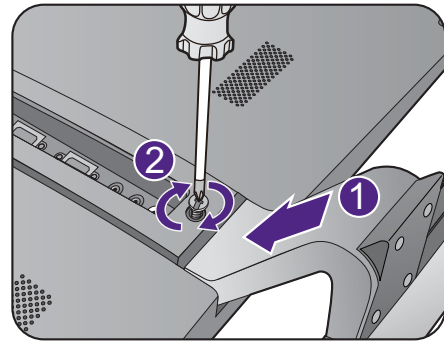

Carefully lift the monitor, turn it over and place it upright on its stand on a flat even surface.

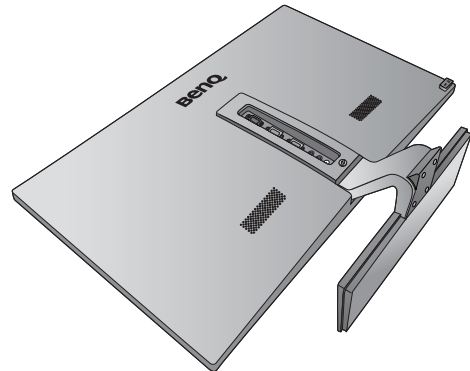

You should position the monitor and angle the screen to minimize unwanted reflections from other light sources.

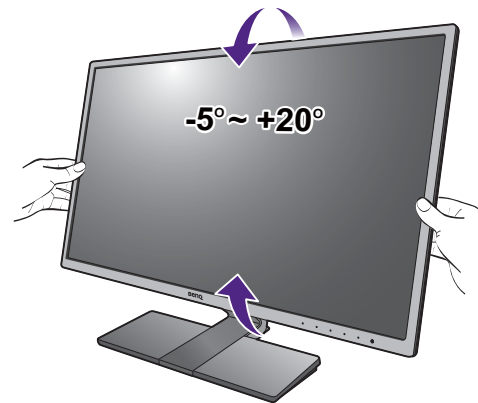

If the screen size is 24 inches, your monitor is an edge to edge monitor and should be handled with care. Adjust the screen angle by placing your hands on the top and on the base of the monitor as illustrated. Excessive force on the display is prohibited.

(EW2440)

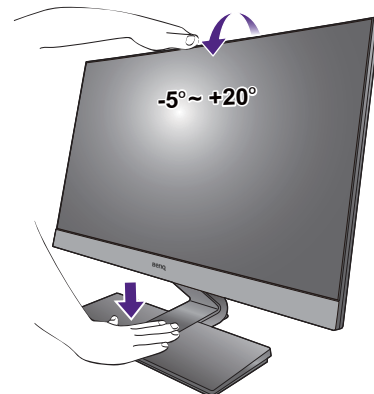

## 2. Connect the PC video cable.

### To Connect the D-Sub Cable

Connect the plug of the D-Sub cable (at the end without the ferrite filter) to the monitor video socket. Connect the other end of the cable (at the end with the ferrite filter) to the computer video socket.

Tighten all finger screws to prevent the plugs from accidentally falling out during use.

### To Connect the HDMI Cable

Connect the plug of the HDMI cable to the HDMI port on the monitor. Connect the other end of the cable to the HDMI port of a digital output device.

### To Connect the MHL Cable

Connect the plug of the MHL cable to the HDMI / MHL port of the monitor. Connect the other end of the cable to the MHL port of the digital output device.

Not all mobile devices are MHL-enabled, consult with your mobile device dealer to verify MHL capabilities.



If there is more than one video transmission method available to you, you might want to take the picture quality of each video cable into consideration before making the connection.

- Better quality: HDMI, MHL
- Good quality: D-Sub



The video cables included in your package and the socket illustrations on the right may vary depending on the product supplied for your region.

Either

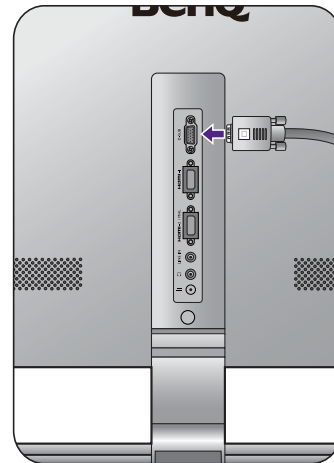

Or

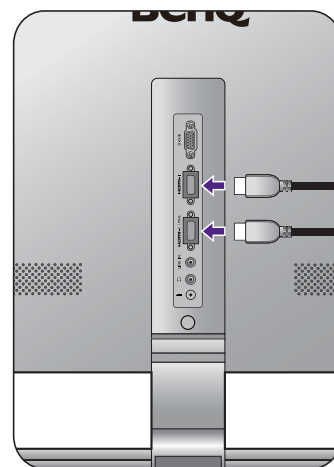

Or

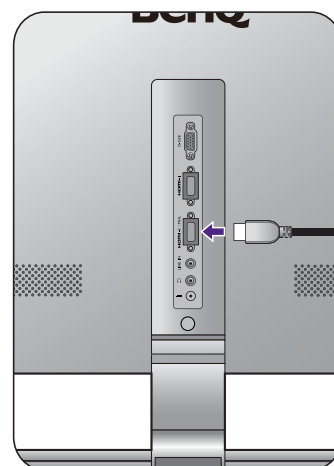

### 3. Connect the audio cable.

Connect the audio cable between the socket on the rear of the monitor (Line In) and your computer audio outlet.

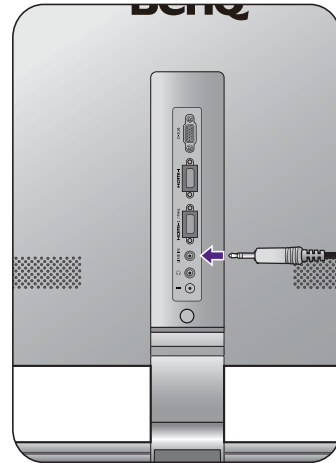

You may connect headphones to the headphone jack found next to the Line In jack of the monitor.

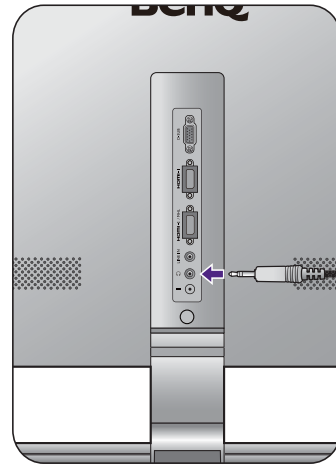

### 4. Connect the power cable to the monitor.

Connect the power cord to the power adapter. Plug one end of the power cord into the socket labelled  on the rear of the monitor. Do not connect the other end to a power outlet just yet.

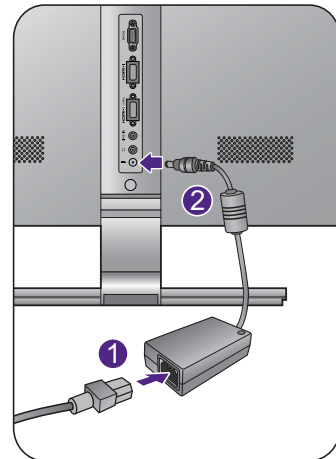

### 5. Organize the cables.

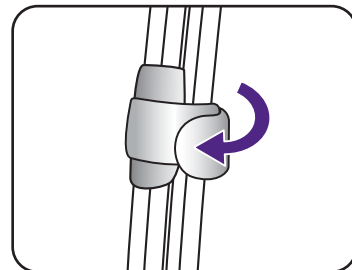
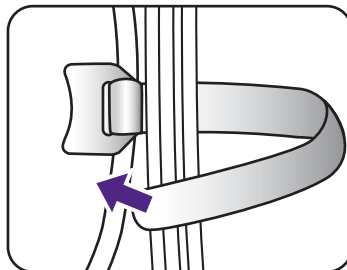
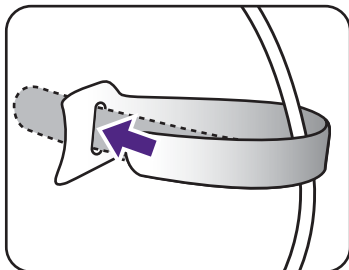

## 6. Connect-to and turn-on the power.

Plug the other end of the power cord into a power outlet and turn it on.



Picture may differ from product supplied for your region.

Turn on the monitor by pressing the power button on the monitor.

Turn on the computer too, and follow the instructions in [Getting the most from your BenQ monitor on page 16](#) to install the monitor software.



To extend the service life of the product, we recommend that you use your computer's power management function.

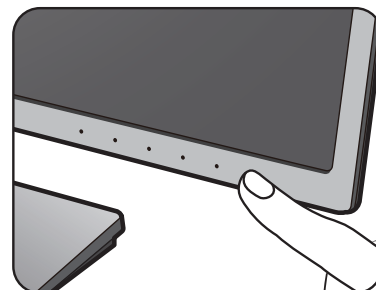
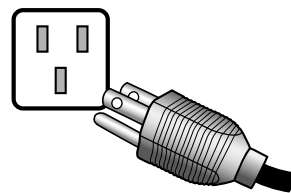

## How to use the phone holder

The phone holder is designed to hold your mobile device (e.g. smartphone) when connected to the monitor using the MHL cable.

### 1. Open the phone holder.

Open the cover of the phone holder, and the inner cover will flip open.

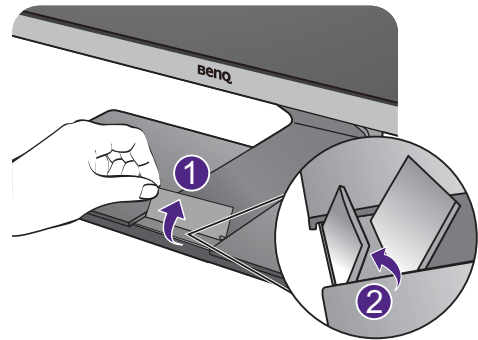

### 2. Place the mobile device on the holder.

Connect the device to your monitor using the MHL cable as instructed in [To Connect the MHL Cable on page 11](#).



Not all mobile devices are MHL-enabled, consult with your mobile device dealer to verify MHL capabilities.

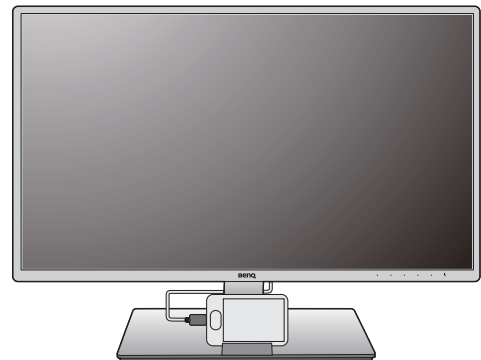

### 3. Close the phone holder covers.

Close the inner cover and then the upper cover as illustrated.

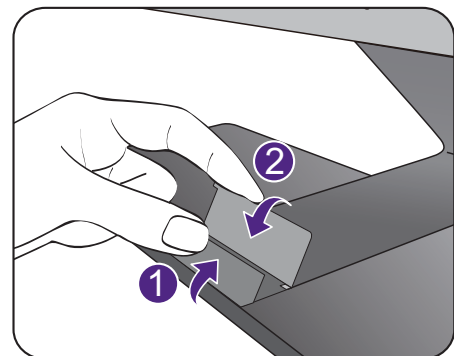

# How to detach the stand and the base

## 1. Prepare the monitor and area.

Turn off the monitor and the power before unplugging the power cable. Turn off the computer before unplugging the monitor signal cable.

Protect the monitor and screen by clearing a flat open area on your desk and placing a soft item like a towel on the desk for padding, before laying the screen face down on a flat clean padded surface.

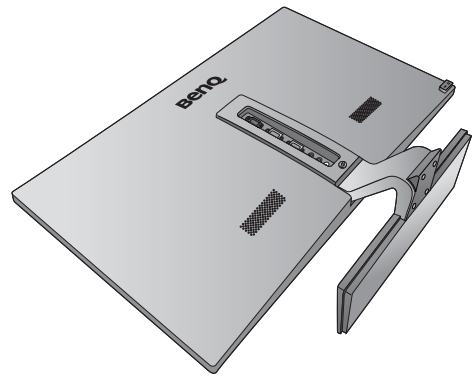

Please be careful to prevent damage to the monitor. Placing the screen surface on an object like a stapler or a mouse will crack the glass or damage the LCD substrate voiding your warranty. Sliding or scraping the monitor around on your desk will scratch or damage the monitor surround and controls.

## 2. Remove the monitor stand.

Release the screw that fixes the stand to the monitor. Then pull the monitor stand backward away from the monitor.



To secure or release a screw, a screwdriver or a coin is required.

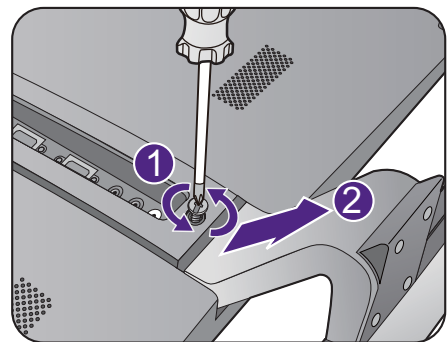

## 3. Remove the monitor base.

Release the screw on the bottom of the monitor base and detach the monitor base as illustrated.



In case you intend to use your monitor on the stand in the future, please keep the monitor base, monitor stand, and screws somewhere safe for future use.

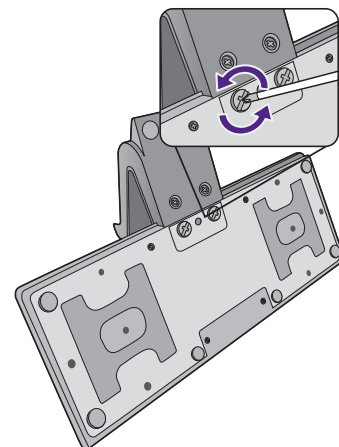

## Getting the most from your BenQ monitor

To gain the most benefit from your new BenQ LCD monitor, you should install the custom BenQ LCD Monitor driver software as provided on the BenQ LCD Monitor CD-ROM.

The circumstances under which you connect and install your BenQ LCD Monitor will determine which process you need to follow to successfully install the BenQ LCD Monitor driver software. These circumstances relate to which version of Microsoft Windows you are using, and whether you are connecting the monitor and installing the software onto a new computer (without existing monitor driver software), or whether you are upgrading an existing installation (which already has existing monitor driver software) with a newer monitor.

In either case however, the very next time you turn on your computer (after connecting the monitor to your computer), Windows will automatically recognize the new (or different) hardware, and will launch its **Found New Hardware wizard**.

Follow the wizard instructions until it asks you to select a monitor model. At that point, click the **Have Disk** button, insert the BenQ LCD Monitor CD-ROM and select the appropriate monitor model. Further details and step-by-step instructions for either an automatic (new) or upgrade (existing) installation, see:

- [How to install the monitor on a new computer on page 17.](#)
- [How to upgrade the monitor on an existing computer on page 18.](#)



- If you require a User Name and Password to login to your Windows computer, you must be logged on as an Administrator or as a member of the Administrators group in order to install the monitor driver software. Furthermore, if your computer is connected to a network which has security access requirements, network policy settings may prevent you from installing software on your computer.
  - To check the name of the purchased model, refer to the specification label on the back of the monitor.
-



## How to install the monitor on a new computer

This instruction details the procedure for selecting and installing the BenQ LCD Monitor driver software on a new computer which has never had a monitor driver installed before. This instruction is only suitable for a computer which has never been used before, and for which the BenQ LCD Monitor is the first ever monitor to be connected to it.



If you are adding the BenQ LCD Monitor to an existing computer that has already had another monitor connected to it (and has monitor driver software installed), you should not be following these instructions. You should instead be following the instructions for [How to upgrade the monitor on an existing computer](#).

1. Follow the instructions in [Getting the most from your BenQ monitor on page 16](#).  
When Windows starts, it will automatically detect the new monitor and launch the **Found New Hardware Wizard**. Follow the prompts until it displays the option to **Install Hardware Device Drivers**.
2. Insert the BenQ LCD Monitor CD-ROM into a CD drive on the computer.
3. Check **Search for a suitable driver for my device** option, and click **Next**.
4. Check the option for CD-ROM drives (uncheck all others) and click **Next**.
5. Look to confirm that the wizard has selected the correct name of your monitor and click **Next**.
6. Click **Finish**.
7. Restart the computer.



To find the suitable driver files for the purchased model, refer to the following table.

Driver files	Suitable models
EW2440L	EW2440L / EW2440LE
EW2740L	EW2740L / EW2740LE

## How to upgrade the monitor on an existing computer

This instruction details the procedure for manually updating the existing monitor driver software on your Microsoft Windows computer. It is currently tested as compatible for Windows 8 and Windows 7 Operating System (OS).



The BenQ LCD Monitor driver for your model may well function perfectly with other versions of Windows, however, as at the time of writing, BenQ has done no testing of this driver on other versions of Windows and cannot guarantee its operation on those systems.

---

Installing monitor driver software involves selecting an appropriate information file (.inf) on the BenQ LCD Monitor CD-ROM for the particular model monitor you have connected, and letting Windows install the corresponding driver files from the CD. You need only steer it in the right direction. Windows has an Upgrade Device Driver Wizard to automate the task and guide you through the file selection and installation process.

See:

- [How to install on Windows 8 system on page 19](#)
- [How to install on Windows 7 system on page 20.](#)

## How to install on Windows 8 system

### 1. Open **Display Properties**.

Move the cursor to the lower-right of the screen or press the **Windows + C** buttons on the keyboard to bring up the **Charm** bar. Go to **Settings, Control Panel, Devices and Printers** and right-click the name of your monitor from the menu.

Alternatively, right-click the desktop and select **Personalize, Display, Devices and Printers**, and right-click the name of your monitor from the menu.

### 2. Select **Properties** from the menu.

### 3. Click the **Hardware** tab.

### 4. Click **Generic PnP Monitor**, and then the **Properties** button.

### 5. Click the **Driver** tab and the **Update Driver** button.

### 6. Insert the BenQ LCD Monitor CD-ROM into a CD drive on the computer.

### 7. In the **Update Driver Software** window, select the option **Browse my computer for driver software**.

### 8. Click **Browse** and navigate to the following directory: d:\BenQ\_LCD\Driver\ (where d is the drive letter designator for the CD-ROM drive).



The drive letter for your CD drive may differ from the example above depending upon your system - it may be 'D:' or 'E:' or 'F:' etc.

---

### 9. Select the correct folder name of your monitor from provided driver list, and click **Next**.

This will copy and install the appropriate monitor driver files to your computer.

### 10. Click **Close**.

You may be prompted to restart your computer after the driver update is complete.

## How to install on Windows 7 system

### 1. Open **Display Properties**.

Go to **Start, Control Panel, Hardware and Sound, Devices and Printers** and right-click the name of your monitor from the menu.

Alternatively, right-click the desktop and select **Personalize, Display, Devices and Printers**, and right-click the name of your monitor from the menu.

### 2. Select **Properties** from the menu.

### 3. Click the **Hardware** tab.

### 4. Click **Generic PnP Monitor**, and then the **Properties** button.

### 5. Click the **Driver** tab and the **Update Driver** button.

### 6. Insert the BenQ LCD Monitor CD-ROM into a CD drive on the computer.

### 7. In the **Update Driver Software** window, select the option **Browse my computer for driver software**.

### 8. Click **Browse** and navigate to the following directory: d:\BenQ\_LCD\Driver\ (where d is the drive letter designator for the CD-ROM drive).



The drive letter for your CD drive may differ from the example above depending upon your system - it may be 'D:' or 'E:' or 'F:' etc.

---

### 9. Select the correct folder name of your monitor from provided driver list, and click **Next**.

This will copy and install the appropriate monitor driver files to your computer.

### 10. Click **Close**.

You may be prompted to restart your computer after the driver update is complete.

# How to adjust your monitor

## The control panel

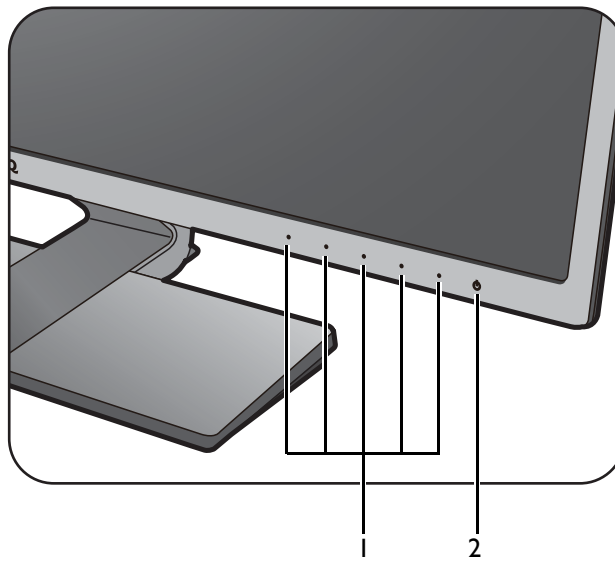

No.	Name	Description
1.	Control keys	Accesses the functions or menu items displayed on the screen, right next to each key.
2.	Power key	Turns the power on or off.

## Basic menu operation

All OSD (On Screen Display) menus can be accessed by the control keys. You can use the OSD menu to adjust all the settings on your monitor.

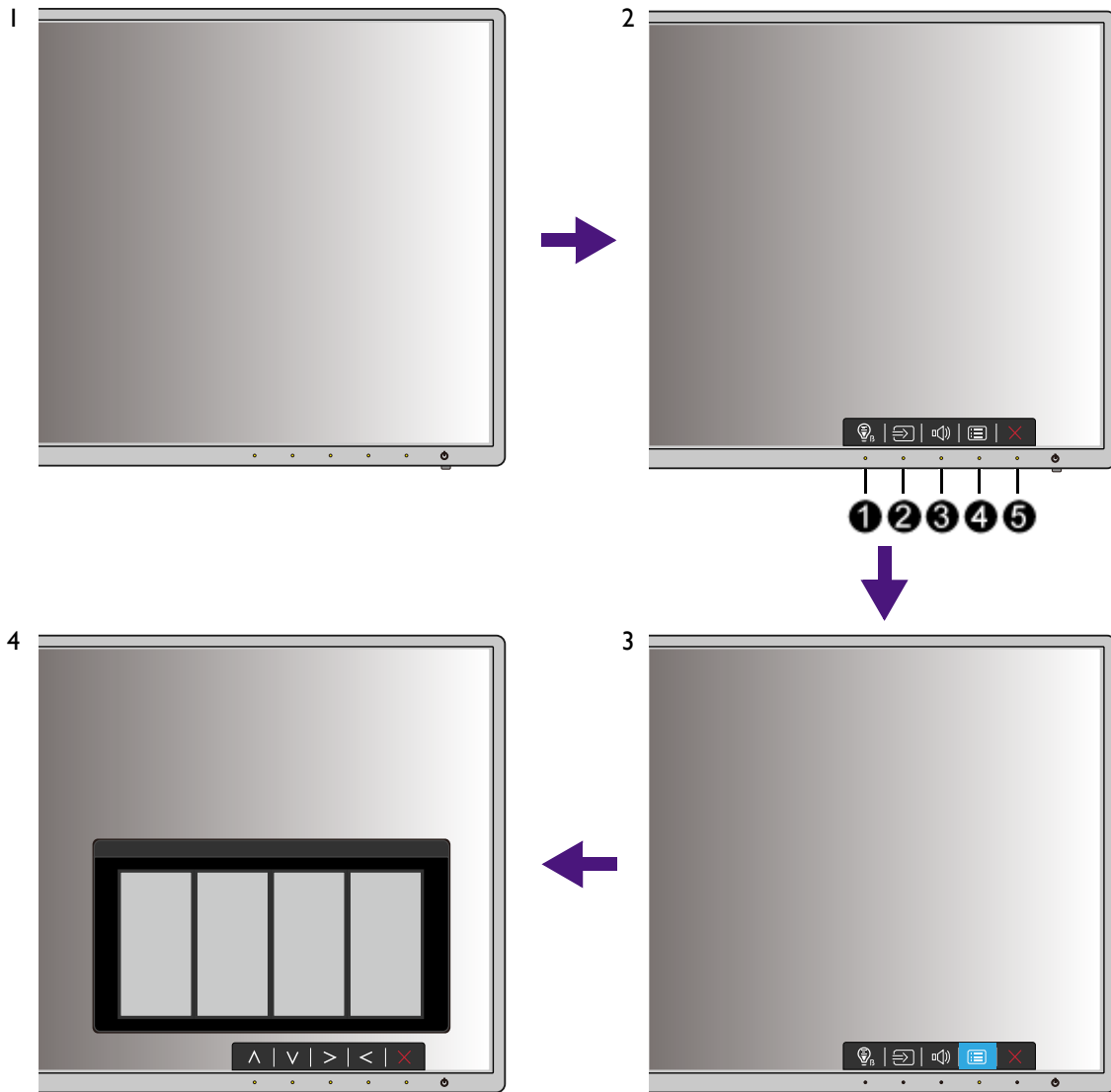

1. Press any of the control keys.
2. The hot key menu is displayed. The left three controls are custom keys and are designated for particular functions.
3. Select **Menu** to access the main menu.
4. In the main menu, follow the icons next to the control keys to make adjustments or selection. See [Navigating the main menu on page 26](#) for details on the menu options.

No.	OSD in hot key menu	OSD icon in main menu	Function
①	Custom Key 1	^	<ul style="list-style-type: none"> <li>• By default, the key is the hot key for <b>Low Blue Light</b>. To change the default settings, see <a href="#">Customizing the hot keys on page 24</a>.</li> <li>• For Up/Increase adjustment.</li> </ul>

No.	OSD in hot key menu	OSD icon in main menu	Function
②	Custom Key 2	∨	<ul style="list-style-type: none"> <li>• By default, the key is the hot key for <b>Input</b>. To change the default settings, see <a href="#">Customizing the hot keys on page 24</a>.</li> <li>• For Down/Decrease adjustment.</li> </ul>
③	Custom Key 3	> / ✓	<ul style="list-style-type: none"> <li>• By default, the key is the hot key for <b>Volume</b>. To change the default settings, see <a href="#">Customizing the hot keys on page 24</a>.</li> <li>• Enters sub menus.</li> <li>• Selects menu items.</li> </ul>
④	Menu	<	<ul style="list-style-type: none"> <li>• Activates the main menu.</li> <li>• Returns to the previous menu.</li> </ul>
⑤	Exit	×	Exits OSD menu.



- OSD = On Screen Display.  
The hot keys only operate while the main menu is not currently displaying. Hot key displays will disappear after a few seconds of no key activity.
- To unlock the OSD controls, press and hold any key for 10 seconds.

## Picture optimization

The easiest way to obtain an optimal display from an analog (D-Sub) input is to use the **Auto Adjustment** function. Go to **Display** and **Auto Adjustment** to optimize the currently displayed image to the screen.



When you connect a digital input signal using a digital (MHL or HDMI) cable to your monitor, the **Auto Adjustment** function will be disabled, because the monitor will automatically display the best image.



Please ensure that the connected graphic card on your computer is set to the native resolution of the monitor when you use the **Auto Adjustment** function.

---

If you wish, you can always adjust the screen geometric settings manually using geometry menu items. To assist you in this endeavour, BenQ has provided a screen test image utility which you can use to check for screen color, grayscale and line gradient display.

1. Run the test program auto.exe from CD-ROM. You could also use any other image, such as the desktop of your operating system. However, we recommend that you use auto.exe. As you run auto.exe, a test pattern displays.
2. Press any of the control keys to bring up the hot key menu. Select **Menu** to enter the main menu.
3. Go to **Display** and **Auto Adjustment**.
4. If you notice a vertical noise (like a curtain effect-shimmering of vertical lines), select **Pixel Clock** and adjust the monitor until the noise disappears.
5. If you notice a horizontal noise, select **Phase** and adjust the monitor until the noise disappears.

## Customizing the hot keys

The left 3 control keys (also called custom keys) perform as hot keys to provide direct access to pre-defined functions. You can change the default setting and designate different functions for these keys.

1. Press any of the control keys to bring up the hot key menu, and press **Menu** to access the main menu.
2. Go to **System**.
3. Select the custom key you want to change.
4. In the sub menu, select a function that can be accessed by this key. A pop-up message will appear, showing that the setup is complete.

## Adjusting display mode

To display images of aspect ratio other than 16:9 and size other than the panel size of your purchased model, you can adjust the display mode on the monitor.

1. Press any of the control keys to bring up the hot key menu, and press **Menu** to access the main menu.
2. Go to **Picture Advanced** and **Display Mode**.
3. Select an appropriate display mode. The setting will take effect immediately.



## Choosing an appropriate picture mode

Your monitor provides various picture modes that are suitable for different types of images. See [Picture Mode on page 31](#) for all the available picture modes.

Go to **Picture Advanced** and **Picture Mode** for a desired picture mode. If **Low Blue Light** is preferred, press the first control key (**Custom Key 1**) and select one of the low blue light modes from the list.

## Connecting the monitor to your MacBook series product

While the monitor is connected to your MacBook series product, switch to **M-book** mode which represents MacBook's color matching and visual representation on your monitor.

1. Connect your monitor to the MacBook series product.
2. Go to **Picture Advanced** and **Picture Mode**.
3. Select **M-book**. The setting will take effect immediately.

## Navigating the main menu

You can use the OSD (On Screen Display) menu to adjust all the settings on your monitor. Press any of the control keys to bring up the hot key menu, and press **Menu** to access the main menu. See [Basic menu operation on page 22](#) for details.

Available menu options may vary depending on the input sources, functions and settings. Menu options that are not available will become grayed out. And keys that are not available will be disabled and the corresponding OSD icons will disappear.



The OSD menu languages may differ from the product supplied to your region, see [Language on page 36](#) under **System** and **OSD Settings** for more details.

---

For more information on each menu, please refer to the following pages:

- [Display menu on page 27](#)
- [Picture menu on page 29](#)
- [Picture Advanced menu on page 31](#)
- [Audio menu on page 34](#)
- [System menu on page 35](#)

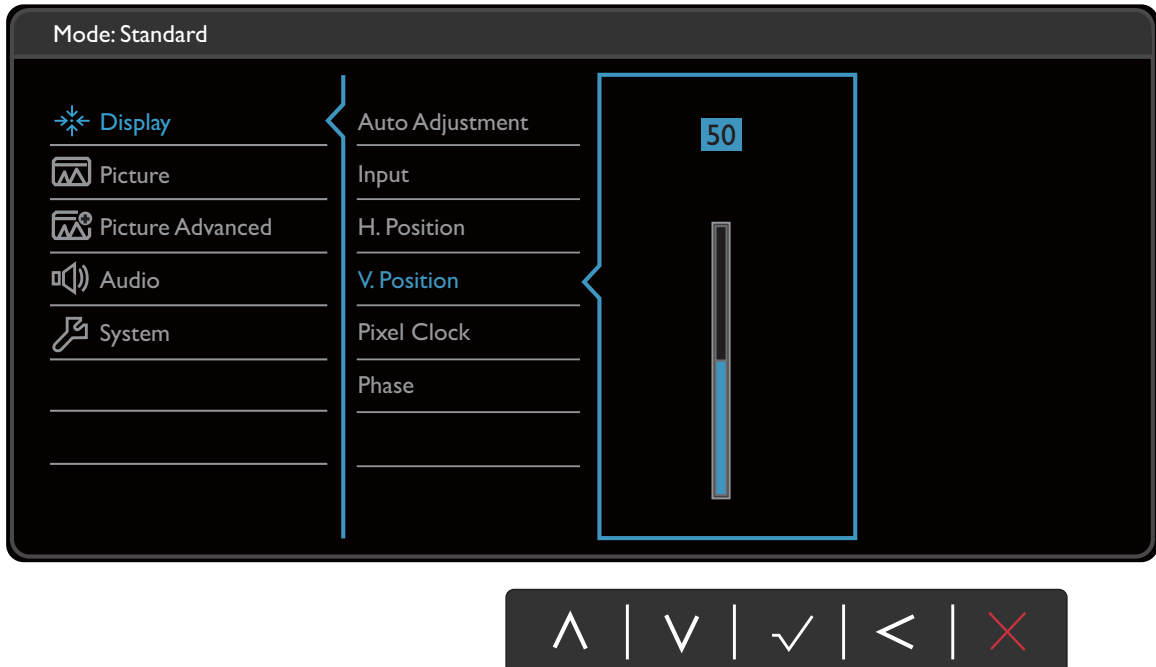

## Display menu

Available menu options may vary depending on the input sources, functions and settings. Menu options that are not available will become grayed out. And keys that are not available will be disabled and the corresponding OSD icons will disappear.



1. Select **Menu** from the hot key menu.
2. Use  $\wedge$  or  $\vee$  to select **Display**.
3. Select  $\triangleright$  to go to a sub menu, and then use  $\wedge$  or  $\vee$  to select a menu item.
4. Use  $\wedge$  or  $\vee$  to make adjustments, or use  $\checkmark$  to make selection.
5. To return to the previous menu, select  $\triangleleft$ .
6. To exit the menu, select  $\times$ .

Item	Function	Range
<b>Auto Adjustment</b>	Optimizes and adjusts the screen settings automatically for you.  Not applicable to a digital input signal.	
<b>Input</b>	Use this to change the input to that appropriate to your video cable connection type.	<ul style="list-style-type: none"> <li>• D-Sub</li> <li>• HDMI 1</li> <li>• HDMI 2</li> </ul>
<b>H. Position</b>	Adjusts the horizontal position of the screen image.	0 to 100
<b>V. Position</b>	Adjusts the vertical position of the screen image.	0 to 100

Item	Function	Range
<b>Pixel Clock</b>	Adjusts the pixel clock frequency timing to synchronize with the analog input video signal. See also: <a href="#">Picture optimization on page 24</a> .   Not applicable to a digital input signal.	0 to 100
<b>Phase</b>	Adjusts the pixel clock phase timing to synchronize with the analog input video signal. See also: <a href="#">Picture optimization on page 24</a> .   Not applicable to a digital input signal.	0 to 63

## Picture menu

Available menu options may vary depending on the input sources, functions and settings. Menu options that are not available will become grayed out. And keys that are not available will be disabled and the corresponding OSD icons will disappear.

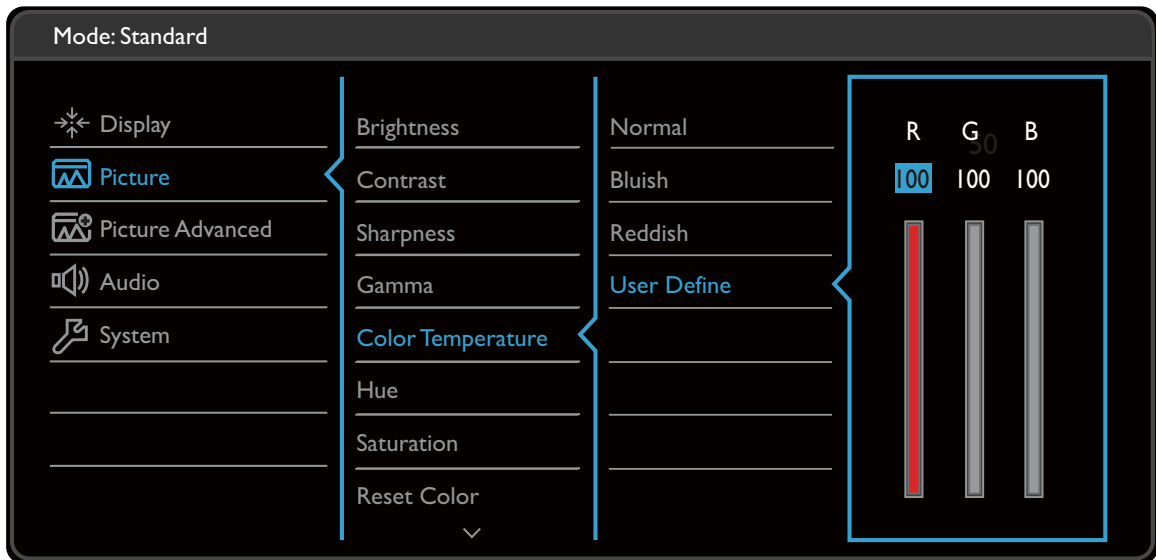

1. Select **Menu** from the hot key menu.
2. Use  $\wedge$  or  $\vee$  to select **Picture**.
3. Select  $\triangleright$  to go to a sub menu, and then use  $\wedge$  or  $\vee$  to select a menu item.
4. Use  $\wedge$  or  $\vee$  to make adjustments, or use  $\checkmark$  to make selection.
5. To return to the previous menu, select  $\triangleleft$ .
6. To exit the menu, select  $\times$ .

Item	Function	Range
<b>Brightness</b>	Adjusts the balance between light and dark shades.	0 to 100
<b>Contrast</b>	Adjusts the degree of difference between darkness and lightness.	0 to 100
<b>Sharpness</b>	Adjusts the clarity and visibility of the edges of the subjects in the image.	1 to 10
<b>Gamma</b>	Adjusts the tone luminance. The default value is 3 (the standard value for Windows).	<ul style="list-style-type: none"> <li>• 1</li> <li>• 2</li> <li>• 3</li> <li>• 4</li> <li>• 5</li> </ul>

Item	Function		Range
<b>Color Temperature</b>	<b>Normal</b>	Allows video and still photographs to be viewed with natural coloring. This is the factory default color.	
	<b>Bluish</b>	Applies a cool tint to the image and is factory pre-set to the PC industry standard white color.	
	<b>Reddish</b>	Applies a warm tint to the image and is factory pre-set to the news print standard white color.	
	<b>User Define</b>	The blend of the Red, Green and Blue primary colors can be altered to change the color tint of the image. Go to the succeeding <b>R</b> (red), <b>G</b> (green), and <b>B</b> (blue) menus to change the settings. Decreasing one or more of the colors will reduce their respective influence on the color tint of the image. (e.g. if you reduce the Blue level the image will gradually take on a yellowish tint. If you reduce Green, the image will become a magenta tint.)	<ul style="list-style-type: none"> <li>• <b>R</b> (0~100)</li> <li>• <b>G</b> (0~100)</li> <li>• <b>B</b> (0~100)</li> </ul>
<b>Hue</b>	Adjusts the degree of how we perceive colors.		0 ~ 100
<b>Saturation</b>	Adjusts the purity degree of colors.		0 ~ 100
<b>Reset Color</b>	Resets the custom color settings to the factory defaults.		<ul style="list-style-type: none"> <li>• <b>YES</b></li> <li>• <b>NO</b></li> </ul>
<b>AMA</b>	Improves the gray level response time of the LCD panel.		<ul style="list-style-type: none"> <li>• <b>OFF</b></li> <li>• <b>High</b></li> <li>• <b>Premium</b></li> </ul>

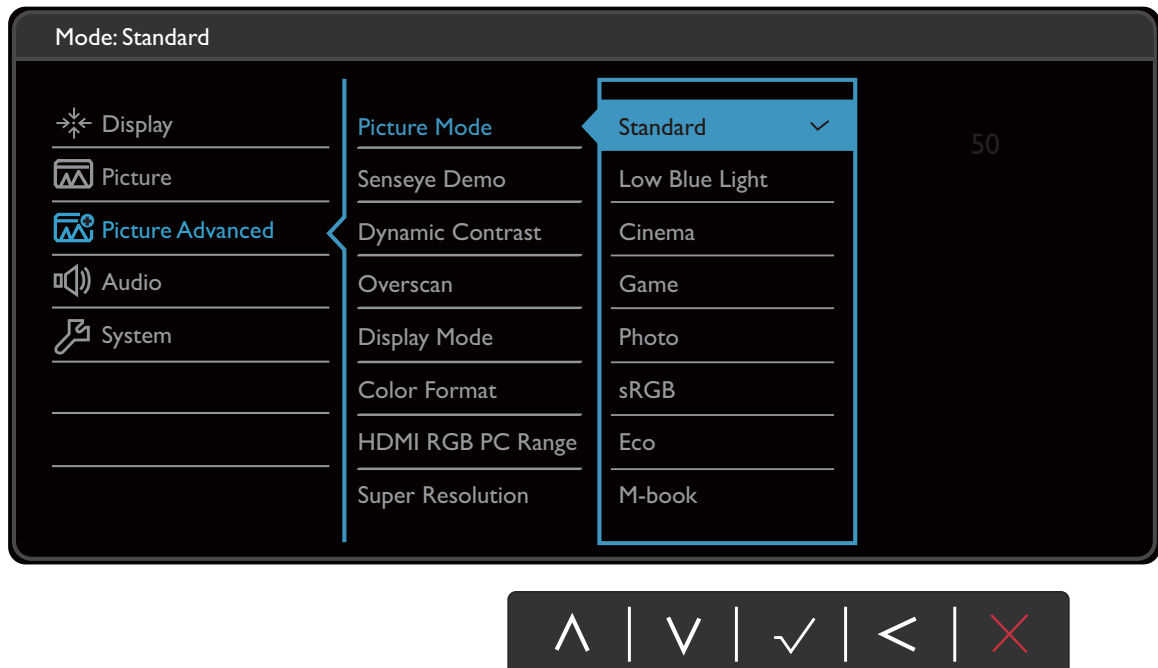

## Picture Advanced menu

Available menu options may vary depending on the input sources, functions and settings. Menu options that are not available will become grayed out. And keys that are not available will be disabled and the corresponding OSD icons will disappear.







1. Select **Menu** from the hot key menu.
2. Use  $\wedge$  or  $\vee$  to select **Picture Advanced**.
3. Select  $\triangleright$  to go to a sub menu, and then use  $\wedge$  or  $\vee$  to select a menu item.
4. Use  $\wedge$  or  $\vee$  to make adjustments, or use  $\checkmark$  to make selection.
5. To return to the previous menu, select  $\triangleleft$ .
6. To exit the menu, select  $\times$ .

Item	Function	Range
<b>Picture Mode</b>	Select a picture mode that best suits the type of images shown on the screen.	
	<b>Standard</b> For basic PC application.	

Item	Function		Range	
	<b>Low Blue Light</b>	<p>Decreases the blue light emitted from the display to reduce the risk of blue light exposure to your eyes.</p>  <p>The value for each <b>Low Blue Light</b> mode indicates how much blue light is decreased compared with the <b>Standard</b> mode.</p>		
	<b>Multimedia</b>	For viewing multimedia files.	-30%	
	<b>Web Surfing</b>	For web surfing.	-50%	
	<b>Office</b>	For office works or office environment.	-60%	
	<b>Reading</b>	For reading e-books or documents.	-70%	
	<b>Cinema</b>	Simulates the experience of movie theater and recommended for viewing videos.		
	<b>Game</b>	For playing video games.		
	<b>Photo</b>	For viewing still images.		
	<b>sRGB</b>	For better color matching representation with the peripheral devices, such as printers, digital cameras, etc.		
	<b>Eco</b>	For saving electricity with low power consumption by providing minimum brightness for all running programs.		
<b>M-Book</b>	Minimizes the visual differences between the monitor and the connected MacBook series product.			
<b>User</b>	Applies a combination of picture settings defined by users.			
<b>Senseye Demo</b>	Displays the preview of screen images under the selected mode from Picture Mode. The screen will be divided into two windows; the left window demonstrates images of Standard mode, while the right window presents the images under the specified mode.		<ul style="list-style-type: none"> <li>• ON</li> <li>• OFF</li> </ul>	
<b>Dynamic Contrast</b>	The function is to automatically detect the distribution of an input visual signal, and then to create the optimal contrast.		0 to 5	
<b>Overscan</b>	<p>Slightly enlarges the input image. Use this feature to hide annoying edge noise if present around your image.</p>  <p>Available only when the input source is HDMI, MHL, or D-Sub (VGA converted from Component).</p>		<ul style="list-style-type: none"> <li>• ON</li> <li>• OFF</li> </ul>	



Item	Function	Range				
<b>Display Mode</b>	<p>This feature is provided to allow aspect ratios other than 16:9 to be displayed without geometric distortion.</p> <p> The options under <b>Display Mode</b> will be different depending on the input signal sources.</p> <p> Depending on your selection of <b>Picture Mode</b>, different <b>Display Mode</b> option is pre-set. Change the setting if needed.</p>					
	<table border="1"> <tr> <td><b>Full</b></td> <td>Scales the input image to fill the screen. Ideal for 16:9 aspect images.</td> </tr> <tr> <td><b>Aspect</b></td> <td>The input image is displayed without geometric distortion filling as much of the display as possible.</td> </tr> </table>	<b>Full</b>	Scales the input image to fill the screen. Ideal for 16:9 aspect images.	<b>Aspect</b>	The input image is displayed without geometric distortion filling as much of the display as possible.	
	<b>Full</b>	Scales the input image to fill the screen. Ideal for 16:9 aspect images.				
<b>Aspect</b>	The input image is displayed without geometric distortion filling as much of the display as possible.					
<b>Color Format</b>	<p>Determines the color space (<b>RGB</b> or <b>YUV</b>) based on the detected video signal.</p> <p> You might need to manually set the <b>Color Format</b> if colors shown on the monitor screen do not display properly.</p> <p> If the input source is HDMI or MHL, color format is not selectable. In other words, <b>Color Format</b> is automatically set depending on the input video source.</p>					
	<table border="1"> <tr> <td><b>RGB</b></td> <td>For D-Sub (VGA) input source from PC.</td> </tr> <tr> <td><b>YUV</b></td> <td>For D-Sub (Component converted from VGA) input source from a video device.</td> </tr> </table>	<b>RGB</b>	For D-Sub (VGA) input source from PC.	<b>YUV</b>	For D-Sub (Component converted from VGA) input source from a video device.	
	<b>RGB</b>	For D-Sub (VGA) input source from PC.				
<b>YUV</b>	For D-Sub (Component converted from VGA) input source from a video device.					
<b>HDMI RGB PC Range</b>	Determines the range of color scales. Select an option that matches the RGB range setting on the connected HDMI or MHL device.	<ul style="list-style-type: none"> <li>• <b>RGB (0 ~ 255)</b></li> <li>• <b>RGB (16 ~ 235)</b></li> </ul>				
<b>Super Resolution</b>	Simulates high-resolution images by increasing pixel density of low-resolution ones.	<ul style="list-style-type: none"> <li>• <b>ON</b></li> <li>• <b>OFF</b></li> <li>• <b>Demo</b></li> </ul>				
<b>Smart Focus</b>	This feature provides a highlight area to focus on certain content, e.g. a YouTube video or a game in windowed mode.					
	<table border="1"> <tr> <td><b>Size</b></td> <td>Determines the size of the highlight area.</td> </tr> </table>	<b>Size</b>	Determines the size of the highlight area.	<ul style="list-style-type: none"> <li>• <b>Small</b></li> <li>• <b>Large</b></li> <li>• <b>OFF</b></li> </ul>		
	<b>Size</b>	Determines the size of the highlight area.				
	<table border="1"> <tr> <td><b>H. Position</b></td> <td>Adjusts the horizontal position of the highlight area.</td> </tr> </table>	<b>H. Position</b>	Adjusts the horizontal position of the highlight area.	0 ~ 100		
	<b>H. Position</b>	Adjusts the horizontal position of the highlight area.				
<table border="1"> <tr> <td><b>V. Position</b></td> <td>Adjusts the vertical position of the highlight area.</td> </tr> </table>	<b>V. Position</b>	Adjusts the vertical position of the highlight area.	0 ~ 100			
<b>V. Position</b>	Adjusts the vertical position of the highlight area.					
<table border="1"> <tr> <td><b>Scaling</b></td> <td>Scales the highlight area.</td> </tr> </table>	<b>Scaling</b>	Scales the highlight area.	0 ~ 100			
<b>Scaling</b>	Scales the highlight area.					

## Audio menu

Available menu options may vary depending on the input sources, functions and settings. Menu options that are not available will become grayed out. And keys that are not available will be disabled and the corresponding OSD icons will disappear.

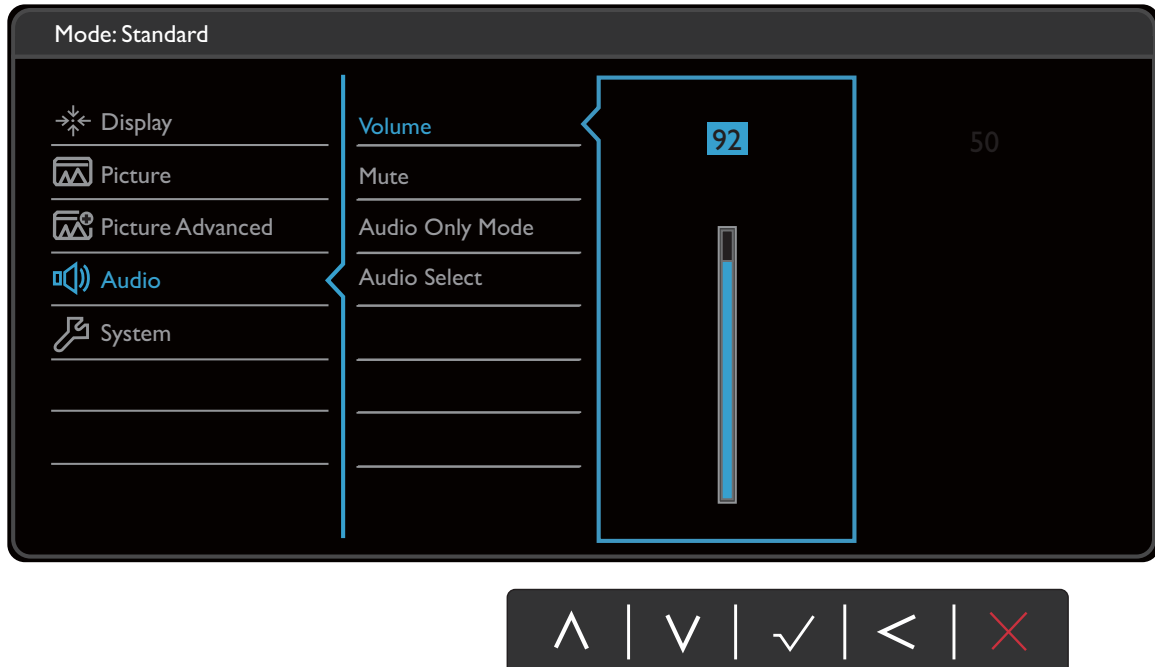

1. Select **Menu** from the hot key menu.
2. Use  $\wedge$  or  $\vee$  to select **Audio**.
3. Select  $\triangleright$  to go to a sub menu, and then use  $\wedge$  or  $\vee$  to select a menu item.
4. Use  $\wedge$  or  $\vee$  to make adjustments, or use  $\checkmark$  to make selection.
5. To return to the previous menu, select  $\triangleleft$ .
6. To exit the menu, select  $\times$ .



Item	Function	Range
<b>Volume</b>	Adjusts the audio volume.	0 ~ 100
<b>Mute</b>	Mutes the audio input.	• ON • OFF
<b>Audio Only mode</b>	If enabled, allows to output audio signal from the built-in speakers even without video source.	• ON • OFF
<b>Audio Select</b>	Allow users to select the audio source or let the monitor detect it automatically.	• PC Audio • HDMI Audio • Auto Detect

## System menu

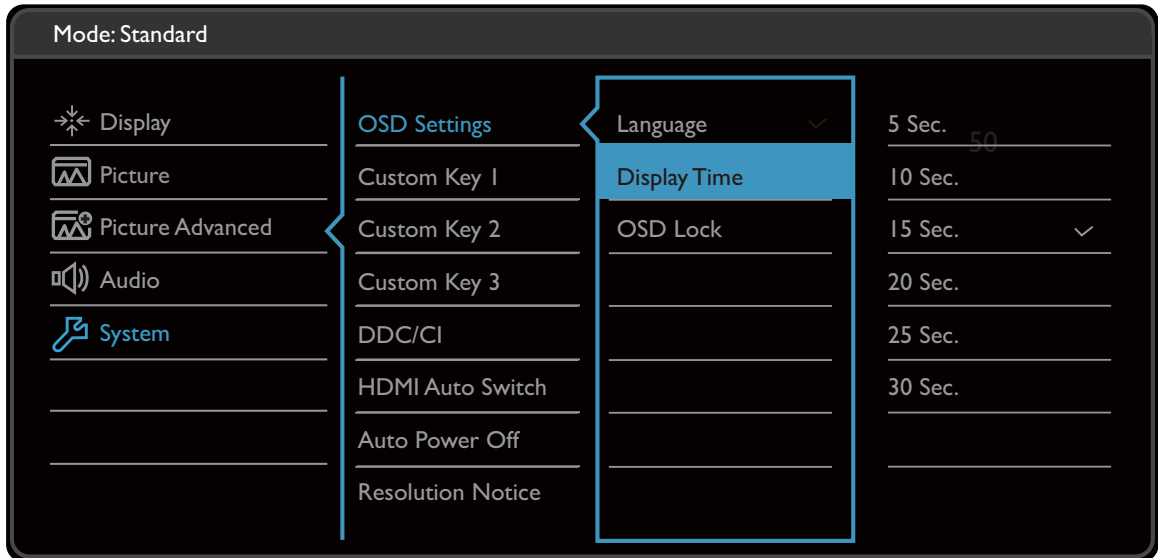
Available menu options may vary depending on the input sources, functions and settings. Menu options that are not available will become grayed out. And keys that are not available will be disabled and the corresponding OSD icons will disappear.

















1. Select **Menu** from the hot key menu.
2. Use  $\wedge$  or  $\vee$  to select **System**.
3. Select  $\triangleright$  to go to a sub menu, and then use  $\wedge$  or  $\vee$  to select a menu item.
4. Use  $\wedge$  or  $\vee$  to make adjustments, or use  $\checkmark$  to make selection.
5. To return to the previous menu, select  $\triangleleft$ .
6. To exit the menu, select  $\times$ .

Item	Function		Range
<b>OSD Settings</b>	<b>Language</b>	Sets the OSD menu language.   The language options displayed on your OSD may differ from those shown on the right, depending on the product supplied in your region.	<ul style="list-style-type: none"> <li>• English</li> <li>• Français</li> <li>• Deutsch</li> <li>• Italiano</li> <li>• Español</li> <li>• Polski</li> <li>• Český</li> <li>• Magyar</li> <li>• SiCG/BIH/CRO</li> <li>• Română</li> <li>• Nederlands</li> <li>• Русский</li> <li>• Svenska</li> <li>• Português</li> <li>• 日本語</li> <li>• 繁體中文</li> <li>• 简体中文</li> </ul>
	<b>Display Time</b>	Adjusts the display time of the OSD menu.	<ul style="list-style-type: none"> <li>• 5 sec.</li> <li>• 10 sec.</li> <li>• 15 sec.</li> <li>• 20 sec.</li> <li>• 25 sec.</li> <li>• 30 sec.</li> </ul>
	<b>OSD Lock</b>	Prevents all the monitor settings from being accidentally changed. When this function is activated, the OSD controls and hotkey operations will be disabled.   To unlock the OSD controls, press and hold any key for 10 seconds.	<ul style="list-style-type: none"> <li>• YES</li> <li>• NO</li> </ul>





Item	Function	Range
<b>Custom Key 1</b>	Sets the function to be accessed by custom key 1.	<ul style="list-style-type: none"> <li>• <b>Picture Mode</b></li> <li>• <b>Low Blue Light</b></li> <li>• <b>Display Mode</b></li> <li>• <b>Brightness</b></li> <li>• <b>Contrast</b></li> <li>• <b>Auto Adjustment</b></li> <li>• <b>Volume</b></li> <li>• <b>Mute</b></li> <li>• <b>Input</b></li> <li>• <b>Super Resolution</b></li> <li>• <b>Smart Focus</b></li> </ul>
<b>Custom Key 2</b>	Sets the function to be accessed by custom key 2.	
<b>Custom Key 3</b>	Sets the function to be accessed by custom key 3.	
<b>DDC/CI</b>	<p>Allows the monitor settings to be set through the software on the PC.</p> <p> DDC/CI, short for Display Data Channel/Command Interface, which was developed by Video Electronics Standards Association (VESA). DDC/CI capability allows monitor controls to be sent via the software for remote diagnostics.</p>	<ul style="list-style-type: none"> <li>• <b>ON</b></li> <li>• <b>OFF</b></li> </ul>
<b>HDMI Auto Switch</b>	When this function is activated, HDMI or HDMI / MHL port will be in the input auto select loop. Otherwise, HDMI or HDMI / MHL can only be selected by input select or by hot key.	<ul style="list-style-type: none"> <li>• <b>ON</b></li> <li>• <b>OFF</b></li> </ul>
<b>Auto Power Off</b>	Sets the time to power off the monitor automatically in power saving mode.	<ul style="list-style-type: none"> <li>• <b>OFF</b></li> <li>• <b>10min.</b></li> <li>• <b>20min.</b></li> <li>• <b>30min.</b></li> </ul>
<b>Resolution Notice</b>	Sets whether to display the resolution notice of the recommended resolution when a new input source is detected by the monitor.	<ul style="list-style-type: none"> <li>• <b>ON</b></li> <li>• <b>OFF</b></li> </ul>
<b>Information</b>	Displays the current monitor property settings.	<ul style="list-style-type: none"> <li>• <b>Input</b></li> <li>• <b>Current Resolution</b></li> <li>• <b>Optimum Resolution (best with the monitor)</b></li> <li>• <b>Model Name</b></li> </ul>
<b>Reset All</b>	Resets all mode, color and geometry settings to the factory default values.	<ul style="list-style-type: none"> <li>• <b>YES</b></li> <li>• <b>NO</b></li> </ul>

# Troubleshooting

## Frequently asked questions (FAQ)

-  The image is blurred.
-  Read the instructions on the link "**Adjusting the Screen Resolution**" on the CD, and then select the correct resolution, refresh rate and make adjustments based on these instructions.
-  How do you use a VGA extension cable?
-  Remove the extension cable for the test. Is the image now in focus? If not, optimize the image by working through the instructions in the "**Adjusting the refresh rate**" section on the link "**Adjusting the Screen Resolution**". It is normal for blurring to occur due to conduction losses in extension cables. You can minimize these losses by using an extension cable with better conduction quality or with a built-in booster.
-  Does the blurring only occur at resolutions lower than the native (maximum) resolution?
-  Read the instructions on the link "**Adjusting the Screen Resolution**" on the CD. Select the native resolution.
-  Pixel errors can be seen.
- One of several pixels is permanently black, one or more pixels are permanently white, one or more pixels are permanently red, green, blue or another color.
- 
  - Clean the LCD screen.
  - Cycle power on-off.
  - These are pixels that are permanently on or off and is a natural defect that occurs in LCD technology.
-  The image has a faulty coloration.
-  It has a yellow, blue or pink appearance.
-  Go to **Picture** and **Reset Color**, and then choose **YES** to reset the color settings to the factory defaults.
- If the image is still not correct and the OSD also has faulty coloration, this means one of the three primary colors is missing in the signal input. Now check the signal cable connectors. If any pin is bent or broken off, please contact your dealer to get necessary support.
-  No image can be seen.
-  Is the prompt on the display illuminated in green?
-  If the LED is illuminated in green and there is a message **Out of Range** on the screen, this means you are using a display mode that this monitor does not support, please change the setting to one of the supported mode. Please read the "**Preset display modes**" section from the link "**Adjusting the Screen Resolution**".

- ? Faint shadow from the static image displayed is visible on the screen.
- ✓ • Activate the power management function to let your computer and monitor go into a low power "sleep" mode when not actively in use.
  - Use a screensaver to prevent the occurrence of image retention.
- ? Is the prompt on the display illuminated in orange?
- ✓ If the LED is illuminated in orange, the power management mode is active. Press any button on the computer keyboard or move the mouse. If that does not help, check the signal cable connectors. If any pin is bent or broken off, please contact your dealer to get necessary support.
- ? Is the prompt on the display not illuminated at all?
- ✓ Check the power supply mains socket, the external power supply and the mains switch.
- ? The image is distorted, flashes or flickers.
- ✓ Read the instructions on the link "**Adjusting the Screen Resolution**" on the CD, and then select the correct resolution, refresh rate and make adjustments based on these instructions.
- ? You are running the monitor at its native resolution, but the image is still distorted.
- ✓ Images from different input sources may appear distorted or stretched on the monitor running at its native resolution. To have the optimal display performance of each type of input sources, you can use the **Display Mode** function to set a proper aspect ratio for the input sources. See [Display Mode on page 33](#) for details.
- ? The image is displaced in one direction.
- ✓ Read the instructions on the link "**Adjusting the Screen Resolution**" on the CD, and then select the correct resolution, refresh rate and make adjustments based on these instructions.
- ? The OSD controls are inaccessible.
- ✓ To unlock the OSD controls when it is preset to be locked, press and hold any key for 10 seconds.
- ? No sound can be heard from the built-in speakers.
- ✓ • Check whether the desired cable to input audio signals is properly connected. See [Connect the audio cable. on page 12](#) for details.
  - Increase the volume (volume may be muted or too low).
  - Remove your headphone and/or external speakers. (If they are connected to the monitor, the built-in speakers are automatically muted.)

-  No sound can be heard from the connected external speakers.
- 
  - Remove your headphone (if the headphone is connected to the monitor).
  - Check whether the headphone jack is properly connected.
  - If the external speakers are USB-powered, check whether the USB connection is OK.
  - Increase the volume (volume may be muted or too low) on the external speakers.
-  Sound cannot be muted.
- 
  - Restart your computer.
  - Update the graphics and/or audio driver.

## Need more help?

If your problems remain after checking this manual, please contact your place of purchase or e-mail us at: [Support@BenQ.com](mailto:Support@BenQ.com).