

ThinkVision

LT2223dwC Flat Panel Monitor User's Guide



OneLink Docking Monitor

Product numbers

60A9-MAR2-WW

First Edition (July 2013)

© Copyright Lenovo 2013.

All rights reserved.

LENOVO products, data, computer software, and services have been developed exclusively at private expense and are sold to governmental entities as commercial items as defined by 48 C.F.R. 2.101 with limited and restricted rights to use, reproduction and disclosure.

LIMITED AND RESTRICTED RIGHTS NOTICE: If products, data, computer software, or services are delivered pursuant a General Services Administration "GSA" contract, use, reproduction, or disclosure is subject to restrictions set forth in Contract No. GS-35F-05925.

Contents

Safety information	iii
Chapter 1. Getting started	1-1
Shipping contents.....	1-1
Product overview.....	1-2
Types of adjustments.....	1-2
User controls	1-3
Cable lock slot.....	1-4
Setting up your monitor.....	1-5
Connecting and turning on your monitor.....	1-5
Registering your option.....	1-12
Chapter 2. Adjusting and using your monitor	2-1
Comfort and accessibility.....	2-1
Arranging your work area.....	2-1
Quick tips for healthy work habits.....	2-2
Accessibility information.....	2-3
Adjusting your monitor image.....	2-3
Using the On-Screen Display (OSD) controls.....	2-3
Selecting a supported display mode.....	2-7
Understanding power management.....	2-9
Caring for your monitor.....	2-9
Detaching the monitor base and stand.....	2-10
wall Mounting (Optional).....	2-10
Chapter 3. Reference information	3-1
Monitor specifications.....	3-1
Troubleshooting.....	3-3
Manual image setup.....	3-4
Manually installing the monitor driver.....	3-5
Service information.....	3-8
Appendix A. Service and Support	A-1
Online technical support	A-1
Telephone technical support	A-1
Appendix B. Notices	B-1
Recycling information	B-2
Trademarks	B-3

Safety information

General Safety guidelines

For tips to help you use your computer safely, go to:

<http://www.lenovo.com/safety>

Before installing this product, read the Safety Information.

مج، يجب قراءة دات السلامة

Antes de instalar este produto, leia as Informações de Segurança.

在安装本产品之前，请仔细阅读 **Safety Information** (安全信息)。

Prije instalacije ovog produkta obavezno pročitajte Sigurnosne Upute.

Před instalací tohoto produktu si přečtěte příručku bezpečnostních instrukcí.

Læs sikkerhedsforskrifterne, før du installerer dette produkt.

Ennen kuin asennat tämän tuotteen, lue turvaohjeet kohdasta Safety Information

Avant d'installer ce produit, lisez les consignes de sécurité.

Vor der Installation dieses Produkts die Sicherheitshinweise lesen.

Πριν εγκαταστήσετε το προϊόν αυτό, διαβάστε τις πληροφορίες ασφαλείας (safety information).

לפני שתתקינו מוצר זה, קראו את הוראות הבטיחות.

A termék telepítése előtt olvassa el a Biztonsági előírásokat!

Prima di installare questo prodotto, leggere le Informazioni sulla Sicurezza

製品の設置の前に、安全情報をお読みください。

본 제품을 설치하기 전에 안전 정보를 읽으십시오.

Пред да се инсталира овој продукт, прочитајте информацијата за безбедност.

Lees voordat u dit product installeert eerst de veiligheidsvoorschriften.

Les sikkerhetsinformasjonen (Safety Information) før du installerer dette produktet.

Przed zainstalowaniem tego produktu, należy zapoznać się

z książką "Informacje dotyczące bezpieczeństwa" (Safety Information).

Antes de instalar este produto, leia as Informações de Segurança.

Перед установкой продукта прочтите инструкции по технике безопасности.

Pred inštaláciou tohto produktu si prečítajte bezpečnostné informácie.

Pred namestitvijo tega proizvoda preberite Varnostne informacije.

Antes de instalar este producto lea la información de seguridad.

Läs säkerhetsinformationen innan du installerar den här produkten.

សូមអានព័ត៌មានសុវត្ថិភាព មុនពេលចាប់ផ្តើមបញ្ចូលកម្មវិធី

安裝本產品之前，請先閱讀「安全諮詢」。

Chapter 1. Getting started

This User's Guide contains detailed information on the ThinkVision® LT2223dwC Flat Panel Monitor. For a quick over view, please see the Setup Poster that was shipped with your monitor.

Shipping contents

The product package should include the following items:

- Information flyer
- Reference and Driver CD
- ThinkVision LT2223dwC Flat Panel Monitor
- Power Cord
- Power Adaptor
- Analog Signal Cable
- USB Cable
- OneLink Cable

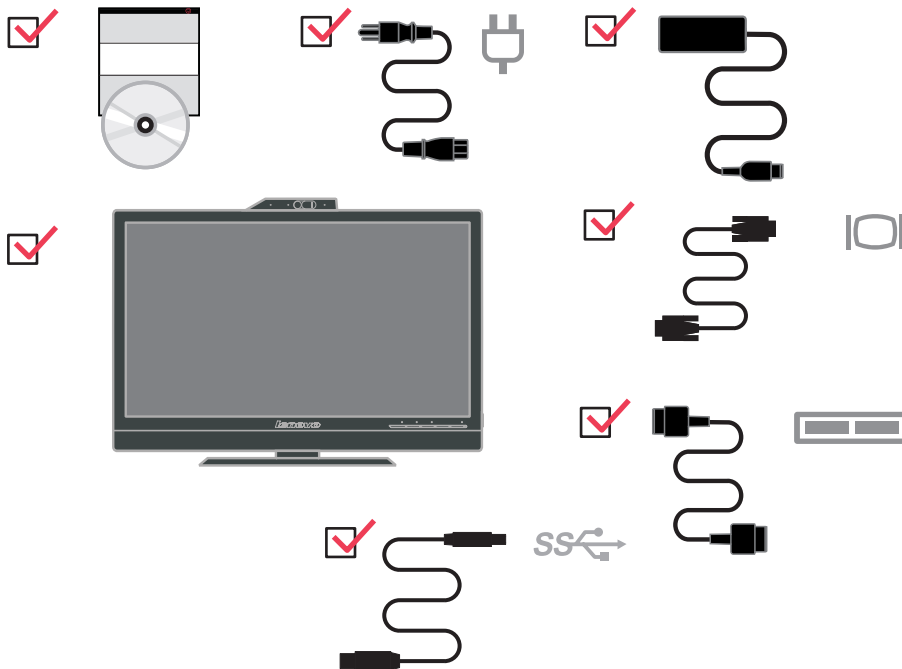

Note: To attach a VESA mount, please see “Detaching the monitor stand” on page 2-10.

Product overview

This section will provide information on adjusting monitor positions, setting user controls, and using the cable lock slot.

Types of adjustments

Tilt

Please see the illustration below for an example of the tilt range.

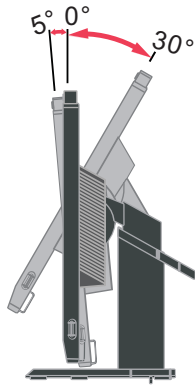

Swivel

With the built-in pedestal, you can tilt and swivel the monitor for the most comfortable viewing angle.

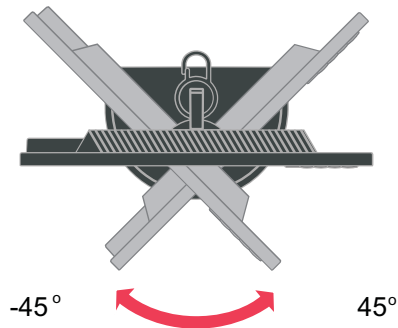

Height Adjustment

Hold the monitor pull up on both sides, adjust the reasonable height of the monitor.

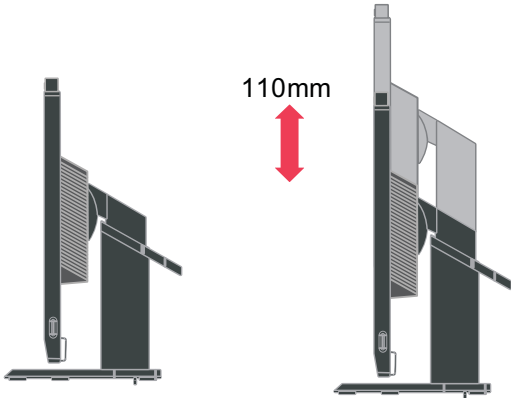

Monitor Pivot

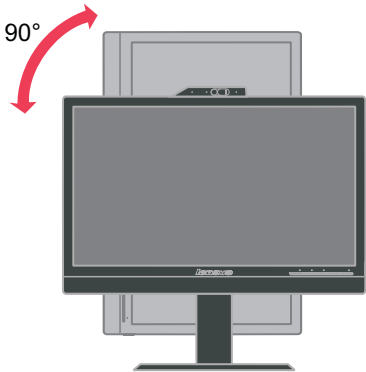

- Adjust height to the top position before rotation the monitor.
- Rotate clockwise until the monitor stops at 90°.

User controls

Your monitor has controls on the front which are used to adjust the display.

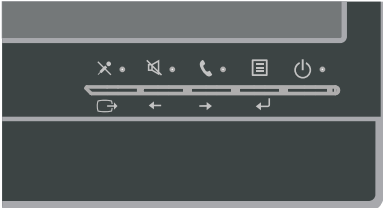

For information on how to use these controls, please see “Adjusting your monitor image” on page 2-3.

Cable lock slot

Your monitor is equipped with a cable lock slot located on the rear of your monitor (in the lower left corner). Please follow the instructions that came with the cable lock to attach it.

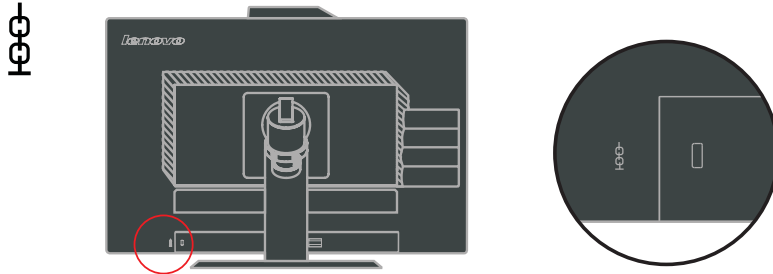

Web-Camera

Your monitor has embedded FHD Web-Camera Module, you can use it on living meeting and other net communication.



Speaker

Your monitor has embedded a pair of speakers with 3W, and it can support OneLink audio output and USB audio output. The USB cable need plug in when you use USB audio channel **(picture 2)**. OneLink audio output doesn't need USB cable but OneLink cable **(picture 1)**.

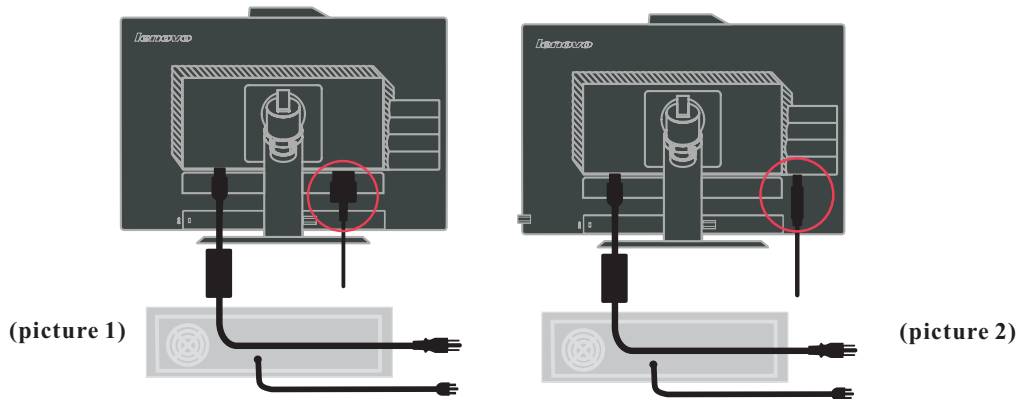

you can push side volume control key to adjust sound of speaker.

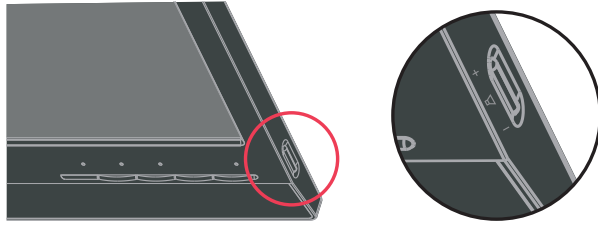

Setting up your monitor

This section provides information to help you set up your monitor.

Connecting and turning on your monitor

Note: Be sure to read the Safety Information located in the information flyer before carrying out this procedure.

Power off your computer and all attached devices, and unplug the computer power cord. Note: Use only power supplies listed in the following.

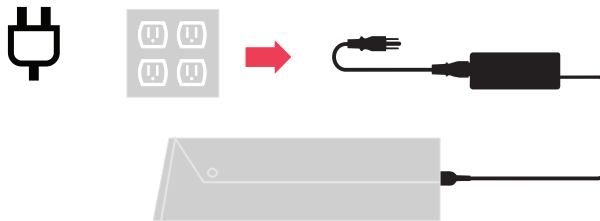

Connect the analog signal cable to the D-SUB connector of the monitor and the other end on the back of the computer.

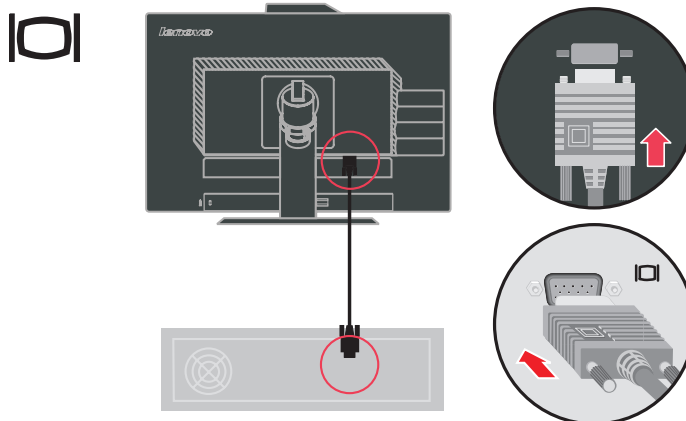

Connect one end of the OneLink cable to the OneLink connector on the back of the computer, and the other end to the OneLink connector on the monitor.

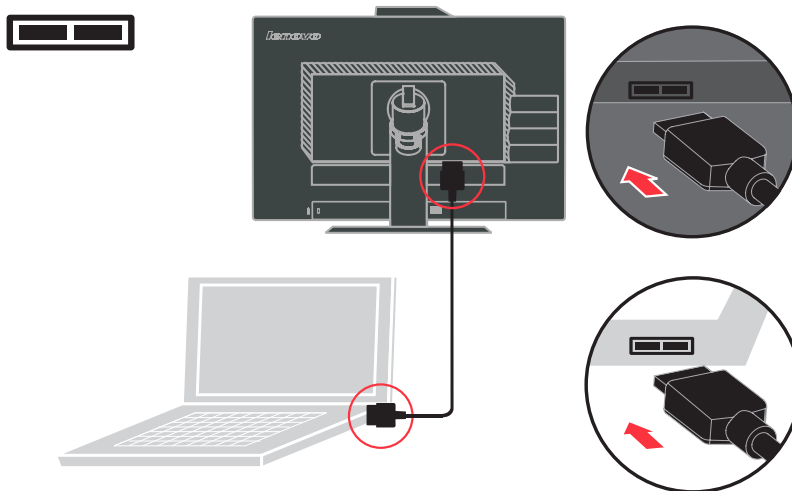

Connect one end of the HDMI cable to the HDMI connector on the back of the computer, and the other end to the HDMI connector on the monitor.

HDMI

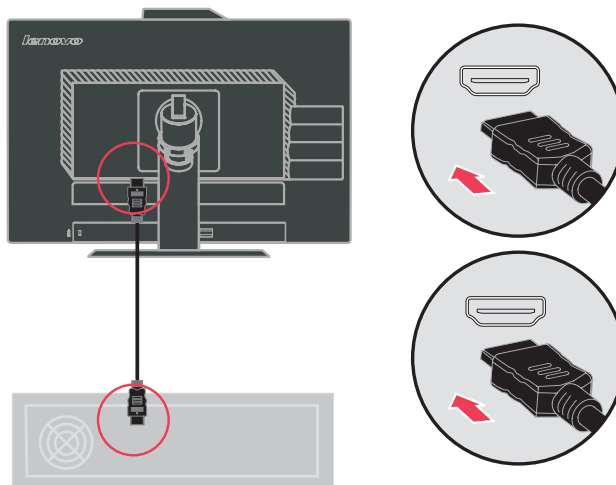

Connect one end of the MHL cable to the monitor MHL port and the other end to the mobile phone. MHL(Mobile-High-Definition Link) is an audio/video interface for directly connecting mobile phones and other portable consumer electronic devices to high-definition displays. This allows user to make the viewing of the connected device on the monitor screen while charging it simultaneously.

MHL

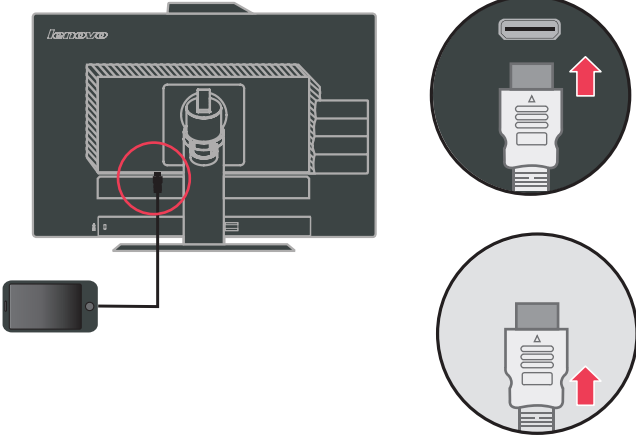

Connect one end of the USB hub cable to the USB connector on the back of the computer, and the other end to the upstream USB connector on the monitor.

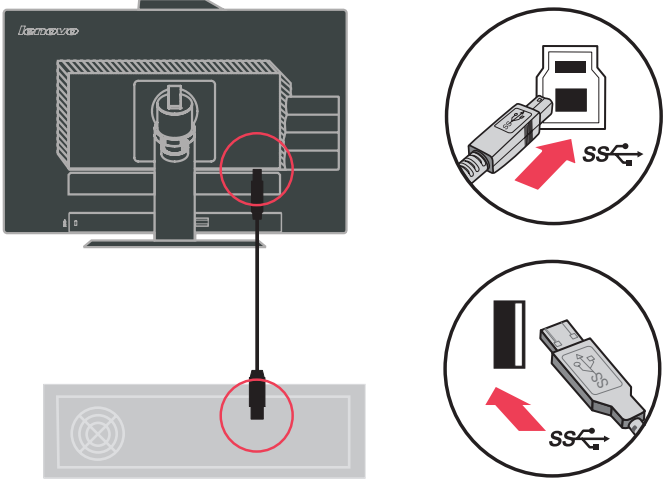

The 2 USB ports on the side are the downstream ports dedicate to USB 3.0 upstream port (on the bottom of monitor), they are compliance with USB 3.0 standard. The top one is compliance USB battery charge standard version 1.2, that can charge portable device, max to 2A current.

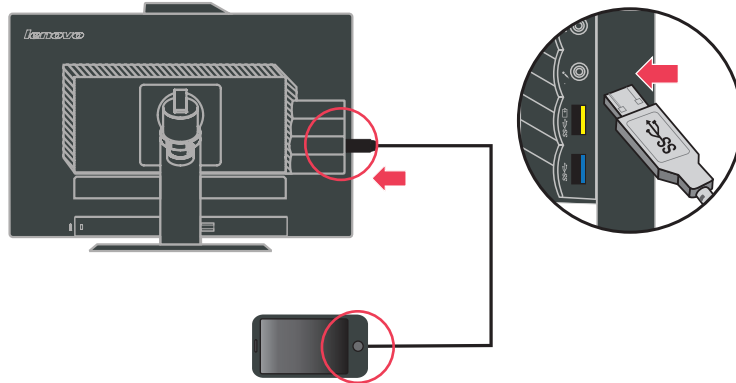

The 2 USB 3.0 ports are the downstream ports connect to USB type keypad , plug in the USB type keypad to this ports or plug in the USB type Mouse to this port.

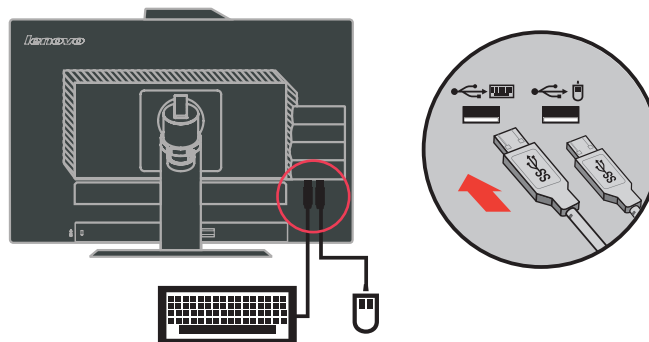
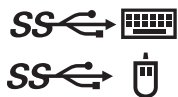

Connect net cable to RJ45 connect.

Note: RJ45 connector support ethernet connection 10/100/1000 Mbps.

Need install the driver of AX88178A from CD.

X:\Ethernet Driver

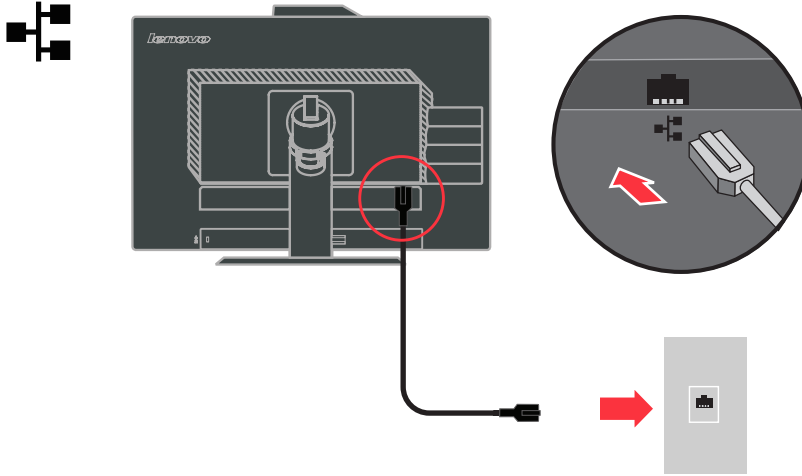

Connect power cord and power adaptor connect the power cord and power adaptor to the monitor, then to a properly grounded AC outlet.

Note: Risk of using a different power supply, please device use one of the below approved power supplies.

Power Adaptor: Manufacturer/ trademark(Lite-On / lenovo, DELTA / lenovo)

Type/ model(ADL135NLC3A, ADL135NDC3A)

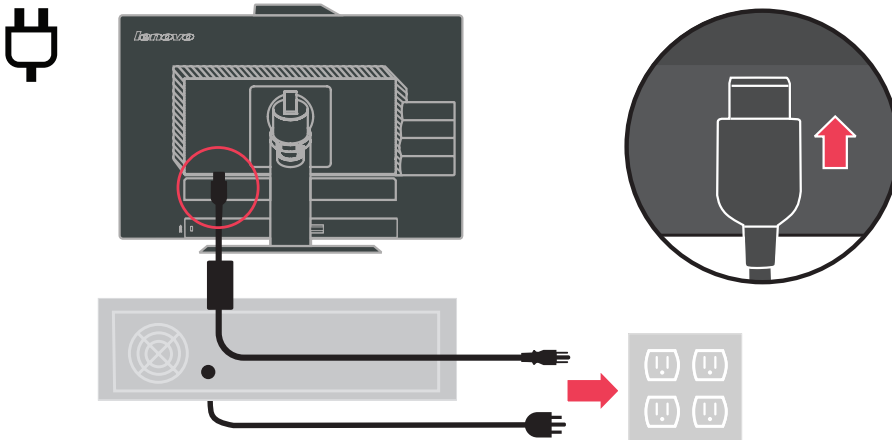

Rotate the head of the monitor into portrait view.

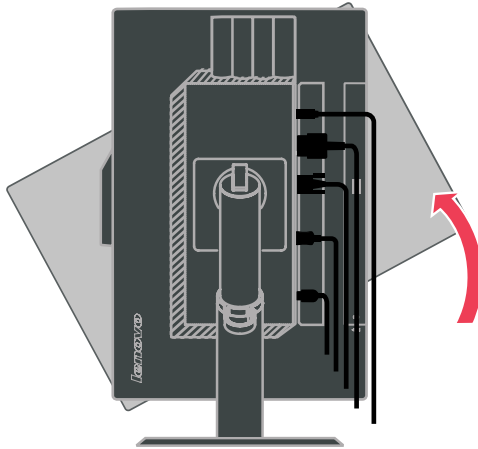

Open the Main Clip and place the cables through the Main Clip.

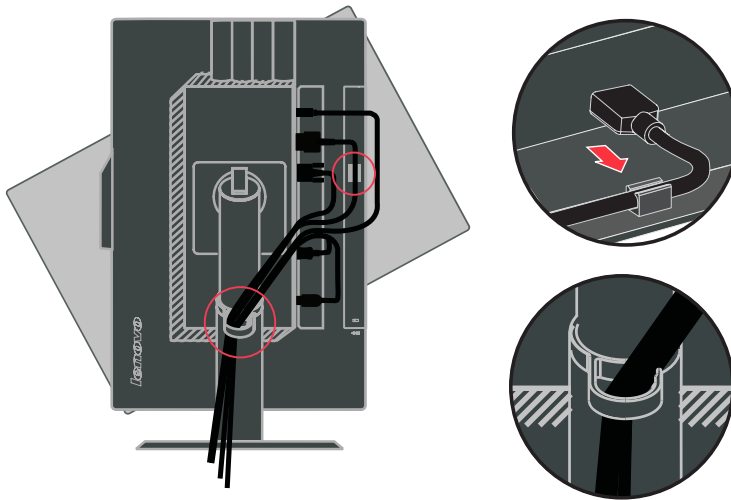

Power on the monitor and the computer.

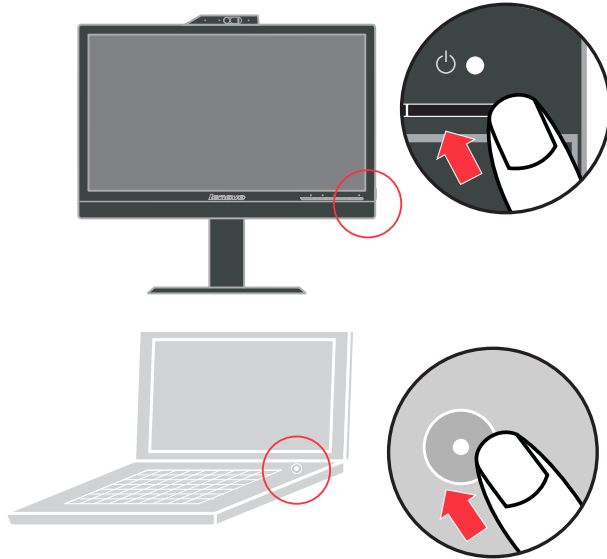

To install the monitor driver, insert the *Reference and Driver CD*, click Install driver, and follow the on-screen instructions.



Registering your option

Thank you for purchasing this Lenovo® product. Please take a few moments to register your product and provide us with information that will help Lenovo to better serve you in the future. Your feedback is valuable to us in developing products and services that are important to you, as well as in developing better ways to communicate with you. Register your option on the following Web site:

<http://www.lenovo.com/register>

Lenovo will send you information and updates on your registered product unless you indicate on the Web site questionnaire that you do not want to receive further information.

Chapter 2. Adjusting and using your monitor

This section will give you information on adjusting and using your monitor.

Comfort and accessibility

Good ergonomic practice is important to get the most from your personal computer and to avoid discomfort. Arrange your workplace and the equipment you use to suit your individual needs and the kind of work that you perform. In addition, use healthy work habits to maximize your performance and comfort while using your computer

.For more detailed information on any of these topics, visit the Healthy Computing Web site at: <http://www.lenovo.com/healthycomputing/>

Arranging your work area

Use a work surface of appropriate height and available working area to allow you to work in comfort.

Organize your work area to match the way you use materials and equipment. Keep your work area clean and clear for the materials that you typically use and place the items that you use most frequently, such as the computer mouse or telephone, within the easiest reach.

Equipment layout and setup play a large role in your working posture. The following topics describe how to optimize equipment setup to achieve and maintain good working posture.

Positioning and viewing your monitor

Position and adjust your computer monitor for comfortable viewing by considering the following items:

- **Viewing distance:** Optimal viewing distances for monitors range from approximately 510mm to 760mm (20 in to 30 in) and can vary depending on ambient light and time of day. You can achieve different viewing distances by repositioning your monitor or by modifying your posture or chair position. Use a viewing distance that is most comfortable for you.
- **Monitor height:** Position the monitor so your head and neck are in a comfortable and neutral (vertical, or upright) position. If your monitor does not have height adjustments, you might have to place books or other sturdy objects under the base of the monitor to achieve the desired height. A general guideline is to position the monitor such that the top of the screen is at or slightly below your eye-height when you are comfortably seated. However, be sure to optimize your monitor height so the line of site between your eyes and the center the monitor suits your preferences for visual distance and comfortable viewing when your eye muscles are in a relaxed stated.

- **Tilt:**

Adjust the tilt of your monitor to optimize the appearance of the screen content and to accommodate your preferred head and neck posture.

- **General location:**

Position your monitor to avoid glare or reflections on the screen from overhead lighting or nearby windows.

The following are some other tips for comfortable viewing of your monitor:

- Use adequate lighting for the type of work you are performing.
- Use the monitor brightness, contrast, and image adjustment controls, if equipped, to optimize the image on your screen to meet your visual preferences.
- Keep your monitor screen clean so you can focus on the screen's contents.

Any concentrated and sustained visual activity can be tiring for your eyes. Be sure to periodically look away from your monitor screen and focus on a far object to allow your eye muscles to relax. If you have questions on eye fatigue or visual discomfort, consult a vision care specialist for advice.

Quick tips for healthy work habits

The following information is a summary of some important factors to consider to help you remain comfortable and productive while you use your computer.

- **Good posture starts with equipment setup:**

The layout of your work area and the setup of your computer equipment have a large effect on your posture while using your computer. Be sure to optimize the position and orientation of your equipment by following the tips outlined in “Arranging your work area” on page 2-1 so you can maintain a comfortable and productive posture. Also, be sure to use the adjustment capabilities of your computer components and office furniture to best suit your preferences now and as your preferences change over time.

- **Minor changes in posture can help avoid discomfort:**

The longer you sit and work with your computer, the more important it is to observe your working posture. Avoid assuming any one posture for an extended period of time. Periodically make minor modifications in your posture to help deter any discomforts that might arise. Make use of any adjustments that your office furniture or equipment provide to accommodate changes in posture

- **Short, periodic breaks help ensure healthy computing:**

Because computing is primarily a static activity, it is particularly important to take short breaks from your work. Periodically, stand up from your work area, stretch, walk for a drink of water, or otherwise take a short break from using your computer. A short break from work gives your body a welcome change in posture and helps to ensure you remain comfortable and productive while you do work.

Accessibility information

Lenovo is committed to providing greater access to information and technology to people with disabilities. With assistive technologies, users can access information in the way most appropriate to their disability. Some of these technologies are already provided in your operating system; others can be purchased through vendors or accessed at:

<http://www-03.ibm.com/research/accessibility/requests/accvpat.nsf/lenovo-bidx?OpenForm>

Adjusting your monitor image

This section describes the user control features used to adjust your monitor image.

Using the On-Screen Display (OSD) controls

The settings adjustable with the user controls are viewed through the On-Screen Display (OSD), as shown below.

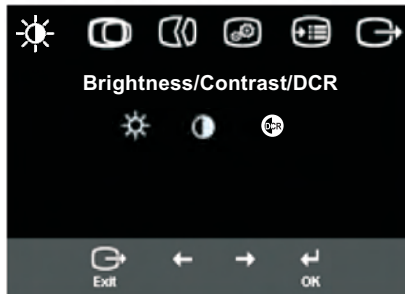























(picture 1)

To use the controls:









1. Press **↵** to open the main OSD menu.
2. Use **←** or **→** to move among the icons. Select an icon and press **↵** to access that function. If there is a sub-menu, you can move between options using **←** or **→**, then press **↵** to select that function. Use **←** or **→** to make adjustments. Press **↵** to save.
3. Press **⏪** to move backwards through the sub-menus and exit from the OSD.
4. Press and hold **↵** for 10 seconds to lock the OSD. This will prevent accidental adjustments to the OSD. Press **↵** and hold for 10 seconds to unlock the OSD and allow adjustments to the OSD.
5. Enables DDC/CI by default. Use OSD Exit Key, Press and hold the **⏪** button for 10 seconds to disable / enable DDC/CI function. The words " DDC/CI Disable /DDC/CI/Enable" shows on the screen.

Table 2-2. OSD functions

OSD Icon on Main Menu	Submenu	Description	Controls and Adjustments (Analog)	Controls and Adjustments (Digital)
 Brightness- /Contrast	 Brightness	Adjusts overall brightness.	 	Same as Analog
	 Contrast	Adjusts difference between light and dark areas.	 	
	 Dynamic Contrast Ratio	This function can improve your video input contrast ration automatically.		
 Image Position	 Horizontal Position	Moves the image left or right.	 	Controls Locked not required for digital input
	 Vertical Position	Moves the image up or down.	 	
 Image Setup	 Automatic	Automatically optimizes the image.		
	 Manual	Manually optimizes the image. See "Menual mage setup" page 3-4. . Clock . Phase . Save		
 Image Properties	 Color	Adjusts intensity of red, green, and blue.		Same as Analog
	Preset mode	• Neutral • sRGB • Reddish • Bluish . Red: Increases or decreases the saturation of "red" in the image. . Green: Increases or decreases the saturation of "green" in the image. . Blue: Increases or decreases the saturation of "blue" in the image. Save: Saves the custom color choices.		
	Custom			
	 Input Signal	This monitor can accept video signals through three differnet connectors. Most desktop computers use a D-SUB connector. Select digital among OSD Controls when you use OneLink connector or HDMI connector. . Selects D-SUB (Analog) . Selects OneLink . Selects HDMI or MHL(if connect HDMI cable,select HDMI,if MHL cable,select MHL)		
 Scaling	Expends image size to full screen. . Off (1 : 1) . On (Full)			

* Note: Brightness and Contrast can not be adjusted in sRGB mode.

Table 2-2. OSD functions (continued)

OSD Icon on Main Menu	Submenu	Description	Controls and Adjustments (Analog)	Controls and Adjustments (Digital)	
 Options	 Information	Shows resolution, refresh rate, and product details. Note: This screen does not allow any changes to the settings.		Same as Analog	
	 Menu Language	This section lists the languages supported by your monitor. Note: The language chosen only affects the language of the OSD. It has no effect on any software running on the computer.			
	 Menu Position	Menu position adjusts menu location on the screen.			
	Default	Returns the menu position to the default settings.			
	Custom	<ul style="list-style-type: none"> . Horizontal: Changes the horizontal position of the OSD. . Vertical: Changes the vertical position of the OSD. . Save 			
	 Factory Default	<ul style="list-style-type: none"> . Cancel . Reset Resets monitor to the original factory settings.			
 Exit		Exit the main menu		Same as Analog	
 Accessibility	Controls button and menu settings for accessibility preferences.  Button repeat rate: Select ← or → to change. <ul style="list-style-type: none"> . Off . Default . Slow  Menu time out: Sets the length of time the OSD will remain active after the last time a button is pressed.				

Selecting a supported display mode

The display mode the monitor uses is controlled by the computer. Therefore, refer to your computer documentation for details on how to change display modes.

The image size, position and shape might change when the display mode changes. This is normal and the image can be readjusted using automatic image setup and the image controls.

Unlike CRT monitors, which require a high refresh rate to minimize flicker, LCD or Flat Panel technology is inherently flicker-free.

Note: If your system has previously been used with a CRT monitor and is currently configured to a display mode outside the range of this monitor, you may need to re-attach the CRT monitor temporarily until you have re-configured the system; preferably to 1920 x 1080 at 60 Hz, which is the Native Resolution Display mode.

The display modes shown below have been optimized at the factory.

Table 2-3. Factory set display modes

Addressability	Refresh rate
640 x 480	60 Hz, 72 Hz, 75 Hz
720 x 400	70 Hz
800 x 600	56 Hz, 60 Hz, 72 Hz, 75 Hz
832 x 624	75 Hz
1024 x 768	60 Hz, 70 Hz, 75 Hz
1152 x 864	75 Hz
1280 x 1024	60 Hz, 70 Hz, 75 Hz
1366 x 768	60 Hz
1440 x 900	60 Hz
1600 x 900	60 Hz, 75 Hz
1680 x 1050	60 Hz
1920 x 1080	60 Hz

Image rotation

Before rotating the monitor, you should set-up your computer to rotate the image. Rotating the image may require special rotation software or you may find that your computer is preloaded with video graphic drivers that allows image rotation. Check the Graphic Properties setting on your computer to see if this feature is available. Try these steps to check if image rotation is available on your computer.

1. Right-click on the desktop and click **Properties**.
2. Select the Settings tab and click **Advanced**.
3. If you have ATI, select the **Rotation** tab and set the preferred rotation. If you have nVidia, click the **nVidia** tab, in the left-hand column select **NV Rotate**, and then select the preferred rotation. If you have Intel, select the **Intel** graphics tab, click **Graphic Properties**, select the **Rotation** tab, and then set the preferred rotation. Check with the manufacturer of your computer to see if graphic drivers with image rotation can be downloaded from their support website.

Audio description:

If your Operation System(OS) is XP, for the XP limitation, 2 phenomena will be happened:

- A) The USB audio is recognized as a speaker phone by PC, Speaker volume control icon will be disappeared when you plug in the USB cable.
- B) Because PC doesn't set the USB audio as the prior audio output automatically when you first plug in the USB cable, and the monitor will not audio output.

You must setup it manually once, please refer to below step:

- 1> Open your “control panel” from the start.
- 2> Then open the “sounds and audio devices”
- 3> Select the “audio” tab.
- 4> Select LT2223dwC as default audio output.
- 5> Apply it.

Understanding power management

Power management is invoked when the computer recognizes that you have not used your mouse or keyboard for a user-definable period. There are several states as described in the table below.

For optimal performance, switch off your monitor at the end of each working day, or whenever you expect to leave it unused for long periods during the day.

Table 2-4. Power indicator

State	Power Indicator	Screen	Restoring Operation	Compliance
On	Steady green	Normal		
Standby/Suspend	Steady amber	Blank	Press a key or move the mouse There may be a slight delay before the image reappears. Note: Standby also occurs if there is no image output to the monitor.	ENERGY STAR
Off	Off	Off	Press the power key There may be a slight delay before the image reappears.	ENERGY STAR

Caring for your monitor

Be sure to turn off the power before you perform any maintenance on the monitor.

Do not:

- Apply water or liquid directly to your monitor.
- Use solvents or abrasives.
- Use flammable cleaning materials to clean your monitor or any other electrical equipment.
- Touch the screen area of your monitor with sharp or abrasive items. This type of contact may cause permanent damage to your screen.
- Use any cleaner which contains an anti-static solution or similar additives. This may harm the coating of the screen area.

Do:

- Lightly dampen a soft cloth with water and use this to gently wipe the covers and the screen.
- Remove grease or finger marks with a damp cloth and a little mild detergent.

Detaching the monitor base and stand

step 1: Place the monitor on a soft and flat surface.

step 2: Remove the base and stand from the monitor.

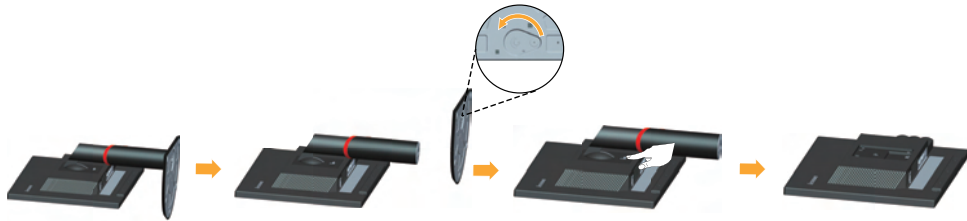

Wall Mounting (Optional)

Refer to the instructions that come with the VESA compatible base mounting kit.

1. Place the monitor face down on a non-abrasive surface on stable flat table.
2. Remove the stand.
3. Attach the mounting bracket from the wall mounting kit to the monitor.
4. Mount the monitor on the wall by following the instructions that come with the base mounting kit.

NOTE: For use only with UL (expand UL) Listed Wall Mount Bracket with minimum weight/load bearing capacity of 6.00 kg.

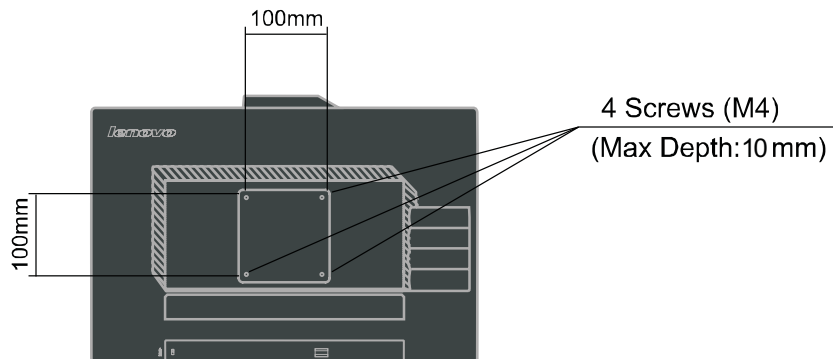

Chapter 3. Reference information

This section contains monitor specifications, instructions to manually install the monitor driver, troubleshooting information, and service information.

Monitor specifications

Table 3-1. Monitor specifications for type-model 60A9-MAR2-WW

Dimensions	Height	379.36 mm
	Depth	218.42 mm
	Width	512.64 mm
Panel	Size	21.5 in.
	Backlight	LED
	Aspect Ratio	16:9
Stand	Tilt range	Range: -5°, +30°
	Swivel	Range: -45°, +45°
	Lift	Range: 110.0mm
	Pivot	Yes (clockwise 90 degree)
VESA mount	Supported	100 mm (3.94 in.)
Image	Viewable image size	546.86 mm (21.5 in.)
	Maximum height	267.79 mm (10.54 in.)
	Maximum width	476.06 mm (18.74 in.)
	Pixel pitch	0.248 mm (0.0098 in.) (V)
Power input	Supply voltage	20V  6.75A
	Max supply current	
Power consumption Note: Power consumption figures are for the monitor and the power supply combined.	Max Consumption (Without USB and charge loading)	< 30 W
	Typical Consumption	< 25 W
	Standby/Suspend	< 0.5 W
	Off	< 0.5 W
Power delivery capability	Max power delivery to NB from OneLink cable	65W (20V, 3.25A)

Table 3-1. Monitor specifications for type-model 60A9-MAR2-WW (continued)

Video input (Analog)	Input signal Horizontal addressability Vertical addressability Clock frequency	Analog Direct Drive, 75 ohm 0.7 V 1920 pixels (max) 1080 lines (max) 205 MHz
Video input (OneLink)	Interface Horizontal addressability Vertical addressability Clock frequency	OneLink 1920 pixels (max) 1080 lines (max) 225 MHz
Communications	VESA DDC	CI
HDMI input	Input signal Horizontal addressability Vertical addressability Clock frequency	TMDS 1920 pixels (max) 1080 lines (max) 165 MHz
Supported Display Modes (VESA Standard modes between noted ranges)	Horizontal frequency	VGA: 30 kHz - 81 kHz DP: 30 kHz - 81 kHz
	Vertical frequency	50 Hz - 75 Hz
	Native Resolution	1920 x 1080 at 60 Hz
Temperature	Operating	0° to 45° C (32° to 104° F)
	Storage	-20° to 60° C (-4° to 140° F)
	Shipping	-20° to 60° C (-4° to 140° F)
Humidity	Operating	10% to 90%
	Storage	10% to 90%
	Shipping	10% to 90%

Troubleshooting

If you have a problem setting up or using your monitor, you might be able to solve it yourself. Before calling your dealer or Lenovo, try the suggested actions that are appropriate to your problem.

Table 3-2. Troubleshootingg

Problem	Possible cause	Suggested action	Reference
The words "Out of Range" are shown on the screen, and the power indicator is flashing green.	The system is set to a display mode which is not supported by the monitor.	<ul style="list-style-type: none"> • If you are replacing an old monitor, reconnect it and adjust the display mode to within the specified range for your new monitor. • If using a Windows system, restart the system in safe mode, then select a supported display mode for your computer. • If these options do not work, contact the Support Center. 	"Selecting a supported display mode" on page 2-7
The image quality is unacceptable.	The video signal cable is not connected with the monitor or system completely.	Be sure the signal cable is firmly plugged into the system and monitor.	"Connecting and turning on your monitor" on Page 1-5
	The color settings may be incorrect.	Select another color setting from the OSD menu.	"Adjusting your monitor image" on page 2-3
	The automatic image setup function was not performed.	Perform automatic image setup.	"Adjusting your monitor image"" on page 2-3
The power indicator is not lit and there is no image.	The monitors power switch is not switched on. The power cord is loose or disconnected. There is no power at the outlet.	Be sure the power cord is connected properly. Be sure the outlet has power. Power on the monitor. Try using another power cord. Try using another electrical outlet.	"Connecting and turning on your monitor" on Page 1-5
when saw the screen show OSD message " The power adapter you are using cannot provide sufficient power to charge the laptop. Refer to your monitor user guide for a list of appropriate adapters." after 10s the OSD is disappear.	The power delivery for power adapter is less than 135W,result in no power supply ability for NB.	Connect 135W or more than 135W power delivery for power adapter.	





Table 3-2. Troubleshootingg(continued)

Problem	Possible cause	Suggested action	Reference
Screen is blank and power indicator is steady amber or flashing green	The monitor is in Standby/Suspend mode	<ul style="list-style-type: none"> Press any key on the keyboard or move the mouse to restore operation. Check the Power Options settings on your computer. 	"Understanding power management" on Page2-9
The power indicator is green, but there is no image.	The video signal cable is loose or disconnected from the system or monitor.	Be sure the video cable is connected with the system properly.	"Connecting and turning on your monitor" on Page 1-5
	The monitor brightness and contrast are at the lowest setting.	Adjust the brightness and contrast setting on the OSD menu.	"Adjusting your monitor image" on page 2-3
One or more of the pixels appear discolored	This is a characteristic of the LCD technology and is not an LCD defect.	If there are more than five pixels missing, contact the Lenovo Support Center.	Appendix A, "Service and Support," on page A-1
<ul style="list-style-type: none"> Fuzzy lines in text or a blurry image. Horizontal or vertical lines through the image. 	<ul style="list-style-type: none"> Image setup has not been optimized Your system Display Properties setting have not been optimized. 	Adjust the resolution settings on your system to match the native resolution for this monitor: 1920x 1080 at 60 Hz.	"Adjusting your monitor image" on page 2-3 "Manual image setup"
		Perform automatic image setup. If automatic image setup does not help, perform manual image setup.	"Selecting a supported display mode" on page 2-7
		When working in the native resolution, you may find additional improvements by adjusting the Dots Per Inch (DPI) setting on your system.	See the Advanced section of your systems display properties.

Manual image setup

If automatic image setup does not establish the image that you prefer, perform manual image setup.

Note: Have your monitor powered on for about 15 minutes, until the monitor warms up.

1. Press  at the bottom of the monitor to open the OSD menu.
2. Use  or  to select  and press  to access.

3. Use ← or → to select **Clock** and **Phase** adjustment.
 - **Clock**(pixel frequency) adjusts the number of pixels scanned by one horizontal sweep. If the frequency is not correct, the screen shows vertical stripes and the picture does not have the correct width.
 - **Phase** adjusts the phase of the pixel clock signal. With a wrong phase adjustment, the picture has horizontal disturbances in light picture.
4. When the image no longer looks distorted, save the Clock and Phase adjustments.
5. Press  to leave the OSD menu.

Manually installing the monitor driver

Below are steps for manually installing the monitor driver in Microsoft® Windows Vista, Microsoft® Windows 7 and Microsoft® Windows 8 Professional.

Installing the monitor driver in Windows Vista

To install the monitor driver in Microsoft® Windows Vista, do the following:

Note: You must download files from the Lenovo Monitor CD to use the Plug and Play feature in Windows Vista.

1. Turn off the computer and all attached devices.
2. Ensure that the monitor is connected correctly.
3. Turn on the monitor and then the system unit. Allow the system to boot into Windows Vista operating system.
4. Click the **Start**, **Control Panel** icon.
5. Click the **Personalization** icon.
6. Click the **Display Settings** icon.
7. Click the **Advanced Settings** button.
8. Click the **Monitor** tab.
9. Click the **Properties** button.
10. Click the **Driver** tab.
11. Open the “**Update Driver Software-Generic PnP Monitor**” window by clicking on **Update Driver**. and then click the “**Browse my computer for driver software**” button.
12. Select “**Let me pick from a list of device drivers on my computer**” and then click the **Next** button.
13. Insert Lenovo Monitor CD into the CD drive and click the **Have Disk** button. Click on the **Browse** button and navigate to the following directory:
X:\Monitor Drivers\Windows Vista
 (where X is the drive letter designator for the CD-ROM drive).
14. Select the "LT2223dwC.inf" file and click the **Open** button. Click the **OK** button.
15. Select Lenovo **LT2223dwC** and click **Next**. The files will be copied from the CD to your hard disk drive.

16. Close all open windows and remove the CD.
17. Restart the system

The system will automatically select the maximum refresh rate and corresponding Color Matching Profiles. .

Note: On LCD monitors, unlike CRTs, a faster refresh rate does not improve display quality. Lenovo recommends using either 1920 x 1080 at a refresh rate of 60 Hz, or 640 x 480 at a refresh rate of 60 Hz.

Installing the monitor driver in Windows 7

To install the device driver in Microsoft® Windows 7, do the following:

Note: You must download files from the Lenovo Monitor CD to use the Plug and Play feature in Windows 7.

1. Turn off the computer and all attached devices.
2. Ensure that the monitor is connected correctly.
3. Turn on the monitor and then the system unit. Allow your computer to start the Windows 7 operating system.
4. Click the **Start**, **Control Panel** icon.
5. Click the **Display** icon.
6. Click the **Display Settings** icon.
7. Click the **Advanced Settings** button.
8. Click the **Monitor** tab.
9. Click the **Properties** button.
10. Click the **Driver** tab.
11. Open the "**Update Driver Software-Generic PnP Monitor**" window by clicking on **Update Driver** and then click the "**Browse my computer for driver software**" button.
12. Select "**Let me pick from a list of device drivers on my computer**" and then click the **Next** button.
13. Insert the Lenovo Monitor CD into the CD drive and click the **Have Disk** button. Click on the **Browse** button and navigate to the following directory:
X:\Monitor Drivers (where **X** is the drive letter designator for the CD-ROM drive).
14. Select the "**LT2223dwC.inf**" file and click the **Open** button. Click the **OK** button.
15. Select **LT2223dwC** and click **Next**. The files will be copied from the CD to your hard disk drive.
16. Close all open windows and remove the CD.
17. Restart the computer.

The system will automatically select the maximum refresh rate and corresponding color Matching profiles. Note: On LCD monitors, unlike CRTs, a faster refresh rate does not improve display quality. Lenovo recommends using either 1920 x 1080 at a refresh rate of 60 Hz, or 640 x 480 at a refresh rate of 60 Hz

Installing the monitor driver in Windows 8

To use the Plug and Play feature in Microsoft Windows 8, do the following:

Note: You must download file from the Reference and Driver CD to use the Plug and Play feature in Windows 8.

1. Turn off the computer, all attached devices.
2. Ensure that the monitor is connected correctly.
3. Turn on the monitor and then the system unit. Allow your computer to start the Windows 8 operating system.
4. Open the Display Properties window by clicking Start, right-click, choose All Application, inter Control Panel and Hardware and Sound icon. and then clicking the Display icon.
5. Click the **Change the display settings** tab
6. Click the **Advanced** Settings icon.
7. Click the **Monitor** tab.
8. Click the **Properties** button.
9. Click the **Driver** tab.
10. Click **Update Driver**, then click **Browse the computer to find the driver program**.
11. Select **Pick from the list of device driver program on the computer**.
12. Click the **Have Disk** button. Click the **Browse** button and navigate to the following directory:
X:\Monitor Drivers\Windows 8
(where X is the drive letter designator for the **CD-ROM** drive).
13. Select the "**LT2223dwC .inf**" file and click the **Open** button. Click the **OK** button.
14. Select **LT2223dwC** and click **Next**. The files will be copied from the CD to your hard disk drive.
15. Close all open windows and remove the CD.
16. Restart the system. The system will automatically select the maximum refresh rate and corresponding Color Matching Profiles.

Note: On LCD monitors, unlike CRTs, a faster refresh rate does not improve display quality. Lenovo recommends using either 1920 x 1080 at a refresh rate of 60 Hz, or 640 x 480 at a refresh rate of 60 Hz.

Getting further help

If you still can't solve your problem, please contact the Lenovo Support Center. For more information on contacting the Customer Support Center, please see Appendix A, "Service and Support," on page A-1.

Service information

Product numbers

The product number for your monitor is located on the back of the display bezel as shown below.

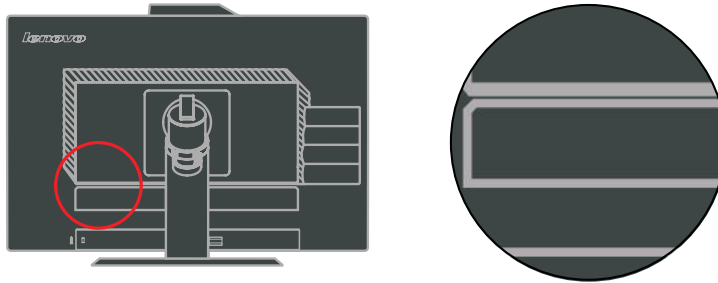

Customer responsibilities

The warranty does not apply to a product which has been damaged due to accident, misuse, abuse, improper installation, usage not in accordance with product specifications and instructions, natural or personal disaster, or unauthorized alterations, repairs or modifications.

The following are examples of misuse or abuse and not covered by warranty:

- Images burned onto the screen of a CRT monitor. Burned image is preventable by utilizing a moving screen saver or power management.
- Physical damage to covers, bezel, base and cables.
- Scratches or punctures on monitor screens.

Service parts

The following parts are for use by Lenovo service, or Lenovo authorized dealers, to support the customer warranty. Parts are for service use only. The table below shows information for model 60A9-MAR2-WW.

Table 3-3. List of service parts

FRU (Field Replaceable Unit) Part number	Description	Color	Machine Type Model(MTM)
03T8469	Monitor_LT2223dwC	Raven Black	60A9-MAR2-WW
03X7995	Analog cable	Raven Black	60A9-MAR2-WW
03T8470	OneLink cable	Raven Black	60A9-MAR2-WW
03X7997	USB cable	Raven Black	60A9-MAR2-WW
45N0501	Power Bick(Delta)	Raven Black	60A9-MAR2-WW
45N0366	Power Bick(Liteon)	Raven Black	60A9-MAR2-WW
03T8472	Stand & Base	Raven Black	60A9-MAR2-WW

Appendix A. Service and Support

The following information describes the technical support that is available for your product, during the warranty period or throughout the life of your product. Refer to the Lenovo Limited Warranty for a full explanation of Lenovo warranty terms.

Registering your option

Register to receive product service and support updates, as well as free and discounted computer accessories and content. Go to:

<http://www.lenovo.com/register>

Online technical support

Online technical support is available during the lifetime of a product at:

<http://www.lenovo.com/support>

Product replacement assistance or exchange of defective components also is available during the warranty period. In addition, if your option is installed in a Lenovo computer, you might be entitled to service at your location. A Lenovo technical support representative can help you determine the best alternative.

Telephone technical support

Installation and configuration support through the Customer Support Center will be available until 90 days after the option has been withdrawn from marketing. After that time, the support is cancelled, or made available for a fee, at Lenovo's discretion. Additional support is also available for a nominal fee.

Before contacting a Lenovo technical support representative, please have the following information available: option name and number, proof of purchase, computer manufacturer, model, serial number and manual, the exact wording of any error message, description of the problem, and the hardware and software configuration information for your system.

Your technical support representative might want to walk you through the problem while you are at your computer during the call.

Telephone numbers are subject to change without notice. The most up-to-date telephone list for Lenovo Support is always available at:

<http://www.lenovo.com/support/phone>

Date and time Update to be Visible on the Website	Country or Regions	Language	Old Telephone Number(s)	New Telephone Number(s)	Hours of Operation	Applicable to IWS
17-May-2012 1000 GMT +4:00	RUSSIA	Russian,	8 800 100 7888	8-800-555-0317	10 am - 7 pm Monday - Saturday	Yes
30-Jul-2012 0900 GMT +9:00	JAPAN	Japanese, English	0120-20-5550, 0570-064-600 For International: +81-46-266-4716	0120-000-817	9AM - 6PM Monday - Sunday (Exception : Third Sunday of the month (due to maintenance activities) and December 30th and 31st and January 1st, 2nd, and 3rd)	
12-Sep-12 0900 GMT +9:00	SOUTH KOREA	Korean, English	1588-6782	080-513-0880 (Toll Free) 0234834817 (Standard Charges Apply)	9AM - 6PM Monday - Friday 9AM - 1PM Saturday	
30-Nov-12 0700 GMT -6:00	Costa Rica	Spanish, English	0-800-011-1029	Dial 0-800-011-4114, then dial 877-404-9661	7 am - 9 pm Monday - Sunday	
30-Nov-12 0900 GMT -4:00	Dominican Republic		1-866-434-2080	877-396-6150	9 am - 11 pm Monday - Sunday	
30-Nov-12 0700 GMT -6:00	El Salvador		800-6264	800-6037	7 am - 9 pm Monday - Sunday	
30-Nov-12 0700 GMT -6:00	Guatemala		1800-624-0051	Dial 999-9190, then dial	7 am - 9 pm Monday - Sunday	
30-Nov-12 0700 GMT -6:00	Honduras		Tegucigalpa: 232-4222 San Pedro Sula: 552-2234	Dial 800-0123, then dial 877-404-9661	7 am - 9 pm Monday - Sunday	
30-Nov-12 0800 GMT -5:00	Panama		206-6047 001-866-434-2080 (Lenovo Customer Support Center- toll free)	001-800-507-2694	8 AM - 10 PM Monday - Sunday	
3-Dec-12 0800 GMT -5:00	ECUADOR		1-800-426911 OPCION 4	(Andinatel) Dial 1-999-119; then dial 877-404-9661 (Pacifictel) 1-800-225-528; then dial 877-404-9661 (Pacifictel Spanish) 1-800-999-119; then dial 877-404-9661	8 AM - 10 PM Monday - Sunday	
3-Dec-12 0800 GMT -6:00	MEXICO		001-866-434-2080	01800 0834916	8 AM - 10 PM Monday - Sunday	

Date and time Update to be Visible on the Website	Country or Regions	Language	Old Telephone Number(s)	New Telephone Number(s)	Hours of Operation	Applicable to IWS
3-Dec-12 0900 GMT -3:00	PARAGUAY	Spanish, English	009-800-52-10026	0098004410084 or 009-800-	9 am - 11 pm Monday - Sunday	Yes
3-Dec-12 1000 GMT -2:00	URUGUAY		000-411-005-6649	000 411 0026332	10 am - 12 pm Monday - Sunday	
5-Dec-12 0900 GMT +8:00	HONG KONG	Cantonese, Mandarin, English		(852) 3071-3561	9 AM - 8 PM Monday - Friday 9AM - 1 PM Saturday	
5-Dec-12 0900 GMT +8:00	Macau		ThinkPad (Technical enquiry hotline): 0800-839 (Macau) ThinkPad Service Center: 2871-5399 (Macau) ThinkCentre, ThinkStation and ThinkServer: 0800-336 (Macau)	0800 807	9 AM - 8 PM Monday - Friday 9AM - 1 PM Saturday	
5-Dec-12 0800 GMT -3:00	CHILE	Spanish, English	800-361-213	1230 020 0173 or 800530008	8 AM - 10 PM Monday - Sunday	
5-Dec-12 0800 GMT -5:00	PERU		0-800-50-866 OPCION 2	0800-77-503	8 AM - 10 PM Monday - Sunday	
5-Dec-12 0830 GMT -4:30	VENEZUELA		0-800-100-2011	08001101111	8:30 am - 10:30 pm Monday - Sunday	
10-Dec-12 0900 GMT -4:00	BOLIVIA		0800-10-0189	800-10-0982	9 am - 11 pm Monday - Sunday	
10-Dec-12 0800 GMT -5:00	COLOMBIA		1-800-912-3021	01800 5182433 (Toll Free) 3207635 (Standard Charges Apply)	8 AM - 10 PM Monday - Sunday	
12-Dec-12 1000 GMT -3:00	ARGENTINA		0800-666-0011	0800 2660570	10 am - 12 pm Monday - Sunday	

Date and time Update to be Visible on the Website	Country or Regions	Language	Old Telephone Number(s)	New Telephone Number(s)	Hours of Operation	Applicable to IWS
01-Sep-12 0000 GMT +10:00	Australia	English	131-426 Think Branded Products 1300-880-917 ThinkServer	1800041267	24 hours/day 7 days/week	Yes
01-Sep-12 0000 GMT +10:00	New Zealand		0800-733-222 Think Branded	0508 770 506	24 hours/day 7 days/week	
14-Sep-12 0830 GMT +7:00	VIETNAM	Vietnamese, English	For Northern Area and Hanoi City: +84-4-3 7367625/+84-4-3 7367626 For Southern Area and Ho Chi Minh City: +84 8 3 8243504/ +84 8 3 8243503	12011072	8:30 AM - 5:30 PM Monday - Friday	
28-Sep-12 0830 GMT +8:00	PHILIPPINES	Tagalog, English	1800-1601-0033 (Local number only) +603 8315 6858 (DID)	180089086454 (Domestic Toll Free) 180014410719 (International Toll Free)	8:30 AM - 5 PM Monday - Friday	
12-Oct-12 0800 GMT +8:00	SINGAPORE	English, Mandarin, Bahasa Malaysia	800 6011 343 (Local number only) +603 8315 6856 (DID)	18004155529	8AM - 6:30PM Monday - Friday	
26-Oct-12 0900 GMT +7:00	THAILAND	Thai, English	1-800-060-066(Local number only) 66 2273 4088+603 8315 6857 (DID)	0018004415734	9 AM -6 PM Monday - Friday	
9-Nov-12 0900 GMT +7:00	INDONESIA	Bahasa Indonesia, English	+6221 2992 5823 001-803-606-282 (Local number only) +603 8315 6859 (DID)	001803442425	9 AM -6 PM Monday - Friday	
14-Nov-12 0900 GMT +8:00	BRUNEI	Bahasa Malaysian, English	801-1041	Dial 800-1111, then dial 8662735446	9 AM -6 PM Monday - Friday	
14-Nov-12 0900 GMT +8:00	MALAYSIA	Bahasa Malaysia, English	1800-88-1889 (Local number only) +603 8315 6855 (DID)	1800880013	9 AM -6 PM Monday - Friday	
30-Nov-12 0000 GMT -4:00	Antigua	English	New	855-882-4402	24 hours a day 7 days a week	
30-Nov-12 0000 GMT -4:00	Aruba		New	855-882-4402	24 hours a day 7 days a week	

Date and time Update to be Visible on the Website	Country or Regions	Language	Old Telephone Number(s)	New Telephone Number(s)	Hours of Operation	Applicable to IWS
30-Nov-12 0000 GMT -5:00	Bahamas	English	New	855-882-4402	24 hours a day 7 days a week	Yes
30-Nov-12 0000 GMT -4:00	Barbados		New	855-882-4402	24 hours a day 7 days a week	
30-Nov-12 0000 GMT -4:00	Bermuda		1-800 426 7378	855-882-4402	24 hours a day 7 days a week	
30-Nov-12 0000 GMT -4:00	British Virgin Islands		New	855-882-4402	24 hours a day 7 days a week	
30-Nov-12 0000 GMT -5:00	Cayman Islands		New	855-882-4402	24 hours a day 7 days a week	
30-Nov-12 0000 GMT -4:00	Curacao		New	855-882-4402	24 hours a day 7 days a week	
30-Nov-12 0000 GMT -4:00	Grenada		New	855-882-4402	24 hours a day 7 days a week	
30-Nov-12 0000 GMT -4:00	Guyana		New	855-882-4402	24 hours a day 7 days a week	
30-Nov-12 0000 GMT -5:00	Jamaica		1-800 426 7378	855-882-4402	24 hours a day 7 days a week	
30-Nov-12 0000 GMT -4:00	Montserrat		New	855-882-4402	24 hours a day 7 days a week	
30-Nov-12 0700 GMT -6:00	Nicaragua	Spanish, English	001-800-220-1830	001-800226-0334	7 am - 9 pm Monday - Sunday	
30-Nov-12 0000 GMT -4:00	Puerto Rico	English	New	855-882-4402	24 hours a day 7 days a week	
30-Nov-12 0000 GMT -4:00	St Kitts		New	855-882-4402	24 hours a day 7 days a week	
30-Nov-12 0000 GMT -4:00	St Lucia		New	855-882-4402	24 hours a day 7 days a week	
30-Nov-12 0000 GMT -4:00	ST MAARTEN		New	855-882-4402	24 hours a day 7 days a week	
30-Nov-12 0000 GMT -4:00	St Vincent		New	855-882-4402	24 hours a day 7 days a week	
30-Nov-12 0000 GMT -3:00	Suriname		New	855-882-4402	24 hours a day 7 days a week	
30-Nov-12 0000 GMT -4:00	Trinidad and Tobago		New	1-8666269587	24 hours a day 7 days a week	
30-Nov-12 0000 GMT -4:00	US Virgin Islands		New	855-882-4402	24 hours a day 7 days a week	
30-Nov-12 0000 GMT -5:00	CANADA	English, French	1-800-565-3344	8882523099	24 hours a day 7 days a week	
30-Nov-12 0000 GMT -5:00	UNITED STATES	English	1-800-426-7378	855-882-4402	24 hours a day 7 days a week	
17-Dec-12 0800 GMT -2:00	BRAZIL	Portuguese	Calls made from within the Sao Paulo region (11) 3889-8986 Calls made from outside the Sao Paulo region 0800-701-4815	0800 885 0500 (Toll Free) (11) 3140-0500 (Standard Charges Apply)	8 AM - 8 PM Monday - Friday 8 AM - 5 PM Saturday	

Appendix B. Notices

Lenovo may not offer the products, services, or features discussed in this document in all countries. Consult your local Lenovo representative for information on the products and services currently available in your area. Any reference to a Lenovo product, program, or service is not intended to state or imply that only that Lenovo product, program, or service may be used. Any functionally equivalent product, program, or service that does not infringe any Lenovo intellectual property right may be used instead. However, it is the user's responsibility to evaluate and verify the operation of any other product, program, or service.

Lenovo may have patents or pending patent applications covering subject matter described in this document. The furnishing of this document does not give you any license to these patents. You can send license inquiries, in writing, to:

*Lenovo (United States), Inc.L
1009 Think Place - Building One
Morrisville, NC 27560
U.S.A.
Attention: Lenovo Director of Licensing*

LENOVO PROVIDES THIS PUBLICATION "AS IS" WITHOUT WARRANTY OF ANY KIND, EITHER EXPRESS OR IMPLIED, INCLUDING, BUT NOT LIMITED TO, THE IMPLIED WARRANTIES OF NON-INFRINGEMENT, MERCHANTABILITY OR FITNESS FOR A PARTICULAR PURPOSE. Some jurisdictions do not allow disclaimer of express or implied warranties in certain transactions, therefore, this statement may not apply to you.

This information could include technical inaccuracies or typographical errors. Changes are periodically made to the information herein; these changes will be incorporated in new editions of the publication. Lenovo may make improvements and/or changes in the product(s) and/or the program(s) described in this publication at any time without notice.

The products described in this document are not intended for use in implantation or other life support applications where malfunction may result in injury or death to persons. The information contained in this document does not affect or change Lenovo product specifications or warranties. Nothing in this document shall operate as an express or implied license or indemnity under the intellectual property rights of Lenovo or third parties. All information contained in this document was obtained in specific environments and is presented as an illustration. The result obtained in other operating environments may vary.

Lenovo may use or distribute any of the information you supply in any way it believes appropriate without incurring any obligation to you.

Any references in this publication to non-Lenovo Web sites are provided for convenience only and do not in any manner serve as an endorsement of those Web sites. The materials at those Web sites are not part of the materials for this Lenovo product, and use of those Web sites is at your own risk.

Any performance data contained herein was determined in a controlled environment. Therefore, the result obtained in other operating environments may vary significantly. Some measurements may have been made on development-level systems and there is no guarantee that these measurements will be the same on generally available systems. Furthermore, some measurements may have been estimated through extrapolation. Actual results may vary. Users of this document should verify the applicable data for their specific environment.

Recycling information

Lenovo encourages owners of information technology (IT) equipment to responsibly recycle their equipment when it is no longer needed. Lenovo offers a variety of programs and services to assist equipment owners in recycling their IT products. For information on recycling Lenovo products, go to:
<http://www.lenovo.com/recycling/japan>

環境配慮に関して

本機器またはモニターの回収リサイクルについて

企業のお客様が、本機器が使用済みとなり廃棄される場合は、資源有効利用促進法の規定により、産業廃棄物として、地域を管轄する県知事あるいは、政令市長の許可を持った産業廃棄物処理業者に適正処理を委託する必要があります。また、弊社では資源有効利用促進法に基づき使用済みパソコンの回収および再利用・再資源化を行う「PC回収リサイクル・サービス」を提供しています。詳細は、<http://www.ibm.com/jp/pc/service/recycle/pcrecycle/> をご参照ください。

また、同法により、家庭で使用済みとなったパソコンのメーカー等による回収再資源化が2003年10月1日よりスタートしました。詳細は、<http://www.ibm.com/jp/pc/service/recycle/pcrecycle/> をご参照ください。

重金属を含む内部部品の廃棄処理について

本機器のプリント基板等には微量の重金属（鉛など）が使用されています。使用後は適切な処理を行うため、上記「本機器またはモニターの回収リサイクルについて」に従って廃棄してください。

Collecting and recycling a disused Lenovo computer or monitor

If you are a company employee and need to dispose of a Lenovo computer or monitor that is the property of the company, you must do so in accordance with the Law for Promotion of Effective Utilization of Resources. Computers and monitors are categorized as industrial waste and should be properly disposed of by an industrial waste disposal contractor certified by a local government. In accordance with the Law for Promotion of Effective Utilization of Resources, Lenovo Japan provides, through its PC Collecting and Recycling Services, for the collecting, reuse, and recycling of disused computers and monitors. For details, visit the Lenovo Web site at www.ibm.com/jp/pc/service/recycle/pcrecycle/. Pursuant to the Law for Promotion of Effective Utilization of Resources, the collecting and recycling of home-used computers and monitors by the manufacturer was begun on October 1, 2003. This service is provided free of charge for home-used computers sold after October 1, 2003. For details, visit the Lenovo Web site at www.ibm.com/jp/pc/service/recycle/personal/.

Disposing of Lenovo computer components

Some Lenovo computer products sold in Japan may have components that contain heavy metals or other environmental sensitive substances. To properly dispose of disused components, such as a printed circuit board or drive, use the methods described above for collecting and recycling a disused computer or monitor.

Trademarks

The following terms are trademarks of Lenovo in the United States, other countries, or both:

- Lenovo
- The Lenovo logo
- ThinkCentre
- ThinkPad
- ThinkVision

Microsoft, Windows, and Windows NT are trademarks of the Microsoft group of companies.

Other company, product, or service names may be trademarks or service marks of others.

Turkish statement of compliance

The Lenovo product meets the requirements of the Republic of Turkey Directive on the Restriction of the Use of Certain Hazardous Substances in Electrical and Electronic Equipment (EEE).

Türkiye EEE Yönetmeliğine Uygunluk Beyanı

Bu Lenovo ürünü, T.C. Çevre ve Orman Bakanlığı'nın "Elektrik ve Elektronik Eşyalarda Bazı Zararlı Maddelerin Kullanımının Sınırlandırılmasına Dair Yönetmelik (EEE)" direktiflerine uygundur.

EEE Yönetmeliğine uygundur.

Lenovo and the Lenovo logo are trademarks of Lenovo in the United States, other countries, or both.

Ukraine RoHS

Цим підтверджуємо, що продукція Леново відповідає вимогам нормативних актів України, які обмежують вміст небезпечних речовин