



MS410 Series

User's Guide

August 2012

www.lexmark.com

Machine type(s):

4514

Model(s):

420, 430

Contents

- Safety information.....5**
- Learning about the printer.....7**
 - Finding information about the printer.....7
 - Selecting a location for the printer.....8
 - Printer configurations.....9
 - Using the printer control panel.....11
 - Understanding the colors of the indicator and Sleep button lights.....12
 - Using the Embedded Web Server.....12
 - Using the Local Printer Settings Utility.....13
- Additional printer setup.....14**
 - Installing internal options.....14
 - Installing hardware options.....19
 - Attaching cables.....20
 - Setting up the printer software.....21
 - Networking.....23
 - Verifying printer setup.....28
- Loading paper and specialty media.....30**
 - Setting the paper size and type.....30
 - Configuring Universal paper settings.....30
 - Using the standard bin and paper stop.....31
 - Loading trays.....31
 - Loading the multipurpose feeder.....36
 - Linking and unlinking trays.....39
- Paper and specialty media guide.....42**
 - Paper guidelines.....42
 - Using specialty media.....44
 - Storing paper.....46
 - Supported paper sizes, types, and weights.....47
- Printing.....50**
 - Printing a document.....50

Printing information pages.....51
Canceling a print job.....51

Understanding the printer menus.....53

Menu list.....53
Paper menu.....53
Reports menu.....62
Network/Ports menu.....63
Security menu.....70
Settings menu.....72

Saving money and the environment.....83

Saving paper and toner.....83
Saving energy.....84
Recycling.....87

Securing the printer.....88

Using the security lock feature.....88
Statement of Volatility.....88
Erasing volatile memory.....89
Erasing non-volatile memory.....89
Finding printer security information.....89

Maintaining the printer.....90

Cleaning the printer.....90
Checking the status of parts and supplies.....90
Estimated number of remaining pages.....91
Ordering supplies.....91
Storing supplies.....93
Replacing supplies.....94
Moving the printer.....97

Managing the printer.....99

Finding advanced networking and administrator information.....99
Checking the virtual display.....99
Viewing reports.....99
Configuring supply notifications from the Embedded Web Server.....99
Modifying confidential print settings.....100

Copying printer settings to other printers.....	101
Restoring factory default settings.....	101
Creating a printer control panel PIN.....	101
Clearing jams.....	103
Avoiding jams.....	103
Understanding jam messages and locations.....	104
Jam, front door [20y.xx].....	106
Jam, rear door [20y.xx].....	109
Jam, standard bin [20y.xx].....	110
Jam, pull tray 1. Push down blue flap. [23y.xx].....	111
Jam, tray [x] [24y.xx].....	112
Jam, MP feeder [250.xx].....	113
Troubleshooting.....	114
Understanding the printer messages.....	114
Solving printer problems.....	123
Solving print problems.....	129
Embedded Web Server does not open.....	151
Contacting customer support.....	152
Notices.....	153
Product information.....	153
Edition notice.....	153
Power consumption.....	157
Index.....	166

Safety information

Connect the power cord to a properly grounded electrical outlet that is near the product and easily accessible.

Do not place or use this product near water or wet locations.

 **CAUTION—POTENTIAL INJURY:** This product uses a laser. Use of controls or adjustments or performance of procedures other than those specified herein may result in hazardous radiation exposure.

This product uses a printing process that heats the print media, and the heat may cause the media to release emissions. You must understand the section in your operating instructions that discusses the guidelines for selecting print media to avoid the possibility of harmful emissions.

 **CAUTION—HOT SURFACE:** The inside of the printer might be hot. To reduce the risk of injury from a hot component, allow the surface to cool before touching.

 **CAUTION—POTENTIAL INJURY:** The lithium battery in this product is not intended to be replaced. There is a danger of explosion if a lithium battery is incorrectly replaced. Do not recharge, disassemble, or incinerate a lithium battery. Discard used lithium batteries according to the manufacturer's instructions and local regulations.

 **CAUTION—POTENTIAL INJURY:** Before moving the printer, follow these guidelines to avoid personal injury or printer damage:

- Turn the printer off using the power switch, and then unplug the power cord from the electrical outlet.
- Disconnect all cords and cables from the printer before moving it.
- If an optional tray is installed, then remove it from the printer. To remove the optional tray, slide the latch on the right side of the tray toward the front of the tray until it *clicks* into place.
- Use the handholds located on both sides of the printer to lift it.
- Make sure your fingers are not under the printer when you set it down.
- Before setting up the printer, make sure there is adequate clearance around it.

Use only the power cord provided with this product or the manufacturer's authorized replacement.

 **CAUTION—SHOCK HAZARD:** If you are accessing the controller board or installing optional hardware or memory devices sometime after setting up the printer, then turn the printer off, and unplug the power cord from the electrical outlet before continuing. If you have any other devices attached to the printer, then turn them off as well, and unplug any cables going into the printer.

 **CAUTION—SHOCK HAZARD:** Make sure that all external connections (such as Ethernet and telephone system connections) are properly installed in their marked plug-in ports.

This product is designed, tested, and approved to meet strict global safety standards with the use of specific manufacturer's components. The safety features of some parts may not always be obvious. The manufacturer is not responsible for the use of other replacement parts.

 **CAUTION—POTENTIAL INJURY:** Do not cut, twist, bind, crush, or place heavy objects on the power cord. Do not subject the power cord to abrasion or stress. Do not pinch the power cord between objects such as furniture and walls. If any of these things happen, a risk of fire or electrical shock results. Inspect the power cord regularly for signs of such problems. Remove the power cord from the electrical outlet before inspecting it.

Refer service or repairs, other than those described in the user documentation, to a service representative.

 **CAUTION—SHOCK HAZARD:** To avoid the risk of electrical shock when cleaning the exterior of the printer, unplug the power cord from the electrical outlet and disconnect all cables from the printer before proceeding.

 **CAUTION—POTENTIAL INJURY:** To reduce the risk of equipment instability, load each tray separately. Keep all other trays closed until needed.

 **CAUTION—SHOCK HAZARD:** Do not set up this product or make any electrical or cabling connections, such as the fax feature, power cord, or telephone, during a lightning storm.

SAVE THESE INSTRUCTIONS.

Learning about the printer

Finding information about the printer

What are you looking for?	Find it here
Initial setup instructions: <ul style="list-style-type: none"> • Connecting the printer • Installing the printer software 	Setup documentation—The setup documentation came with the printer and is also available on the Lexmark Web site at http://support.lexmark.com .
Additional setup and instructions for using the printer: <ul style="list-style-type: none"> • Selecting and storing paper and specialty media • Loading paper • Configuring printer settings • Viewing and printing documents and photos • Setting up and using the printer software • Configuring the printer on a network • Caring for and maintaining the printer • Troubleshooting and solving problems 	<i>User's Guide</i> and <i>Quick Reference Guide</i> —The guides are available on the <i>Software and Documentation</i> CD. For updates, visit our Web site at http://support.lexmark.com .
Instructions for: <ul style="list-style-type: none"> • Connecting the printer to an Ethernet network • Troubleshooting printer connection problems 	<i>Networking Guide</i> —Open the <i>Software and Documentation</i> CD, and then look for <i>Printer and Software Documentation</i> under the Pubs folder. From the list of publications, click the Networking Guide link.
Help using the printer software	Windows or Mac Help—Open a printer software program or application, and then click Help . Click  to view context-sensitive information. Notes: <ul style="list-style-type: none"> • Help is automatically installed with the printer software. • The printer software is located in the printer program folder or on the desktop, depending on your operating system.

What are you looking for?	Find it here
<p>The latest supplemental information, updates, and customer support:</p> <ul style="list-style-type: none"> • Documentation • Driver downloads • Live chat support • E-mail support • Voice support 	<p>Lexmark Support Web site— http://support.lexmark.com</p> <p>Note: Select your country or region, and then select your product to view the appropriate support site.</p> <p>Support telephone numbers and hours of operation for your country or region can be found on the Support Web site or on the printed warranty that came with your printer.</p> <p>Record the following information (located on the store receipt and at the back of the printer), and have it ready when you contact customer support so that they may serve you faster:</p> <ul style="list-style-type: none"> • Machine Type number • Serial number • Date purchased • Store where purchased
<p>Warranty information</p>	<p>Warranty information varies by country or region:</p> <ul style="list-style-type: none"> • In the US—See the Statement of Limited Warranty included with this printer, or at http://support.lexmark.com. • In other countries and regions—See the printed warranty that came with your printer.

Selecting a location for the printer

When selecting a location for the printer, leave enough room to open trays, covers, and doors. If you plan to install any hardware options, then leave enough room for them also. It is important to:

- Set up the printer near a properly grounded and easily accessible electrical outlet.
- Make sure airflow in the room meets the latest revision of the ASHRAE 62 standard or the CEN Technical Committee 156 standard.
- Provide a flat, sturdy, and stable surface.
- Keep the printer:
 - Clean, dry, and free of dust.
 - Away from stray staples and paper clips.
 - Away from the direct airflow of air conditioners, heaters, or ventilators.
 - Free from direct sunlight and humidity extremes.
- Observe the recommended temperatures and avoid fluctuations.

Ambient temperature	16 to 32°C (60 to 90°F)
Storage temperature	-20 to 40°C (-4 to 104°F)

- Allow the following recommended amount of space around the printer for proper ventilation:

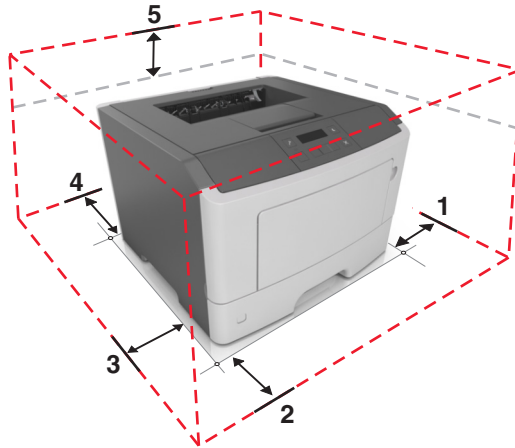

1	Right side	305 mm (12 in.)
2	Front	510 mm (20 in.)
3	Left side	205 mm (8 in.)
4	Rear	205 mm (8 in.)
5	Top	305 mm (12 in.)

Printer configurations

⚠ CAUTION—POTENTIAL INJURY: To reduce the risk of equipment instability, load each tray separately. Keep all other trays closed until needed.

You can configure your printer by adding one optional 250- or 550-sheet tray. For instructions on installing the optional tray, see “Installing optional trays” on page 19.

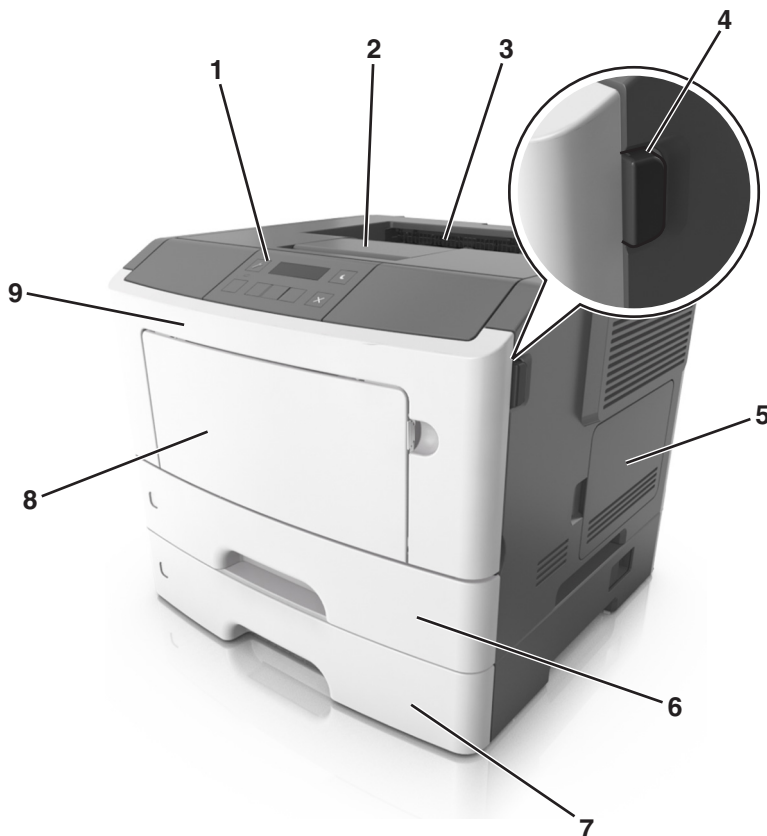

1	Printer control panel
2	Paper stop
3	Standard bin
4	Front door release button
5	Controller board access door
6	Standard 250-sheet tray
7	Optional 250- or 550-sheet tray
8	50-sheet multipurpose feeder
9	Front door

Using the printer control panel

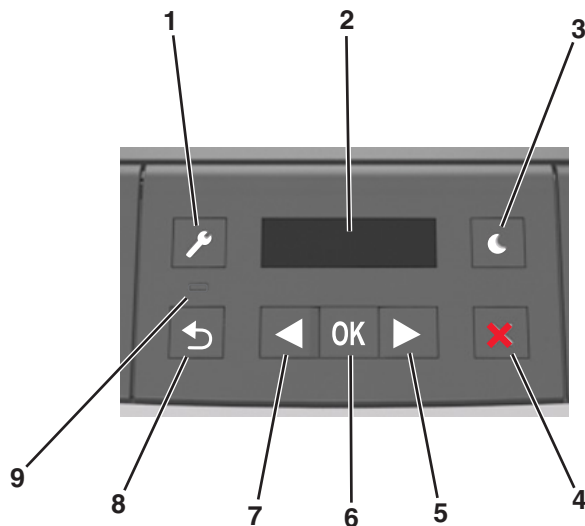

	Use the	To
1	Menu button	Open the menus. Notes: <ul style="list-style-type: none"> The menus are available only when the printer is in the Ready state. Pressing the button while navigating within the menus returns the printer control panel to the top-level menu screen.
2	Display	View printing options as well as status and error messages.
3	Sleep button	Enable Sleep mode or Hibernate mode. Notes: <ul style="list-style-type: none"> Pressing any hard button will cause the printer to wake from Sleep mode. Pressing the Sleep button or the power switch will cause the printer to wake from Hibernate mode.
4	Stop button	<ul style="list-style-type: none"> Exit the menus and return to the Ready state. Stop printer activities, such as printing or downloading fonts.
5	Right arrow button	<ul style="list-style-type: none"> Scroll through menus or to move between screens and menu options. Scroll through settings or text. For menus with numeric values, press and hold an arrow button to scroll through the settings. Release the button when the value you want appears.
6	Select button	<ul style="list-style-type: none"> Open a menu. Display available values or settings for a menu. The current default setting is indicated by an asterisk (*). Save the displayed value as the new user default setting.
7	Left arrow button	<ul style="list-style-type: none"> Scroll through menus or to move between screens and menu options. Scroll through settings or text. For menus with numeric values, press and hold an arrow button to scroll through the settings. Release the button when the value you want appears.
8	Back button	Return to the previous screen.

	Use the	To
9	Indicator light	Determine the status of the printer.

Understanding the colors of the indicator and Sleep button lights

The colors of the indicator and Sleep button lights on the printer control panel signify a certain printer status or condition.

Indicator light color and its corresponding printer status

Indicator light	Printer status
Off	The printer is off or in Hibernate mode.
Blinking green	The printer is warming up, processing data, or printing.
Solid green	The printer is on, but idle.
Blinking red	The printer requires user intervention.

Sleep button light color and its corresponding printer status

Sleep button light	Printer status
Off	The printer is idle or in Ready state.
Solid amber	The printer is in Sleep mode.
Blinking amber	The printer is waking from or entering Hibernate mode.
Blinking amber for 0.1 second, then goes completely off for 1.9 seconds in pulsing pattern	The printer is in Hibernate mode.

Using the Embedded Web Server

Note: This feature is available only in network printers or printers connected to print servers.

If the printer is installed on a network, then you can use the Embedded Web Server to do the following:

- View the virtual display of the printer control panel.
- Check the status of the printer supplies.
- Configure supply notifications.
- Configure printer settings.
- Configure network settings.
- View reports.

To access the Embedded Web Server for your printer:

- 1 Obtain the printer IP address:
 - From the TCP/IP section in the Network/Ports menu
 - By printing a network setup page or menu settings page, and then finding the TCP/IP section

Notes:

- An IP address appears as four sets of numbers separated by periods, such as 123.123.123.123.
- If you are using a proxy server, then temporarily disable it to load the Web page correctly.

2 Open a Web browser, and then type the printer IP address in the address field.

3 Press **Enter**.

The Embedded Web Server page appears.

Using the Local Printer Settings Utility

The Local Printer Settings Utility lets you change and save settings for a printer that is connected to a computer locally through a USB or parallel cable.

To download and install the Local Printer Settings Utility, see “Installing the Local Printer Settings Utility” on page 22.

To access the Local Printer Settings Utility:

- 1** Click  or **Start**.
- 2** Click **Programs > Lexmark > Local Printer Settings Utility**.

To save your settings, click **Actions > Apply Settings**.

You can also distribute your settings to other printers by saving the settings in a command file. To save your settings in a command file, click **Actions > Save As Command File**.

Additional printer setup

Installing internal options

CAUTION—SHOCK HAZARD: If you are accessing the controller board or installing optional hardware or memory devices sometime after setting up the printer, then turn the printer off, and unplug the power cord from the electrical outlet before continuing. If you have any other devices attached to the printer, then turn them off as well, and unplug any cables going into the printer.

Available internal options

Memory cards

- Printer memory
- Flash memory
- Fonts

Note: Some internal options are available only in select printer models.

Accessing the controller board

CAUTION—SHOCK HAZARD: If you are accessing the controller board or installing optional hardware or memory devices sometime after setting up the printer, then turn the printer off, and unplug the power cord from the electrical outlet before continuing. If you have any other devices attached to the printer, then turn them off as well, and unplug any cables going into the printer.

- 1 Open the controller board access door.

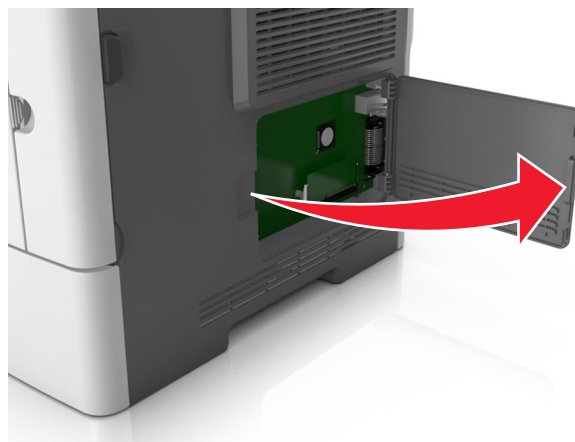

- 2 Use the following illustration to locate the appropriate connector.

Warning—Potential Damage: Controller board electronic components are easily damaged by static electricity. Touch a metal surface on the printer before touching any controller board electronic components or connectors.

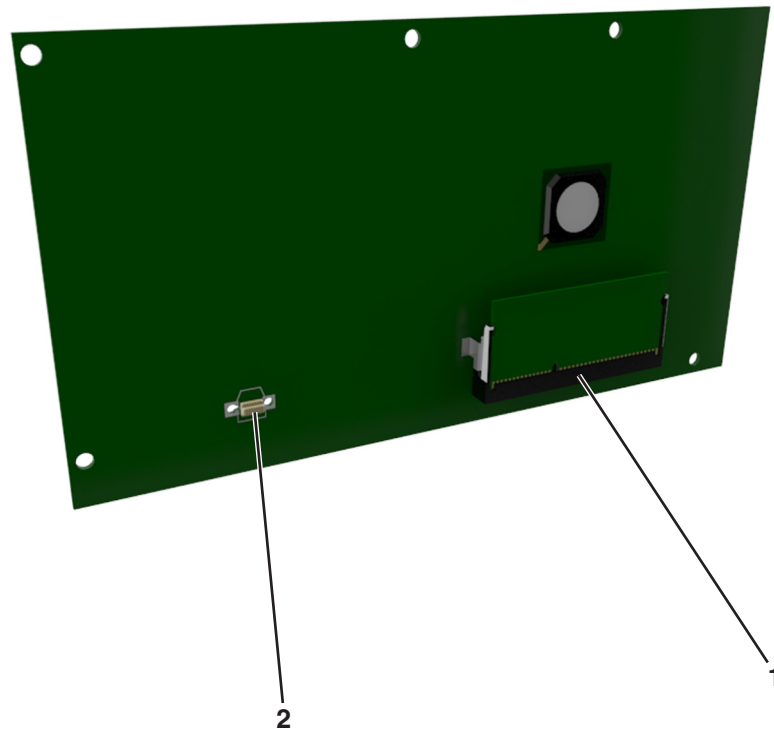

1	Memory card connector
2	Option card connector

Installing a memory card

CAUTION—SHOCK HAZARD: If you are accessing the controller board or installing optional hardware or memory devices sometime after setting up the printer, then turn the printer off, and unplug the power cord from the electrical outlet before continuing. If you have any other devices attached to the printer, then turn them off as well, and unplug any cables going into the printer.

Warning—Potential Damage: Controller board electronic components are easily damaged by static electricity. Touch a metal surface on the printer before touching any controller board electronic components or connectors.

An optional memory card can be purchased separately and attached to the controller board.

1 Access the controller board.

For more information, see “Accessing the controller board” on page 14.

2 Unpack the memory card.

Warning—Potential Damage: Do not touch the connection points along the edge of the card. Doing so may cause damage.

- 3 Align the notch (1) on the memory card with the ridge (2) on the connector.

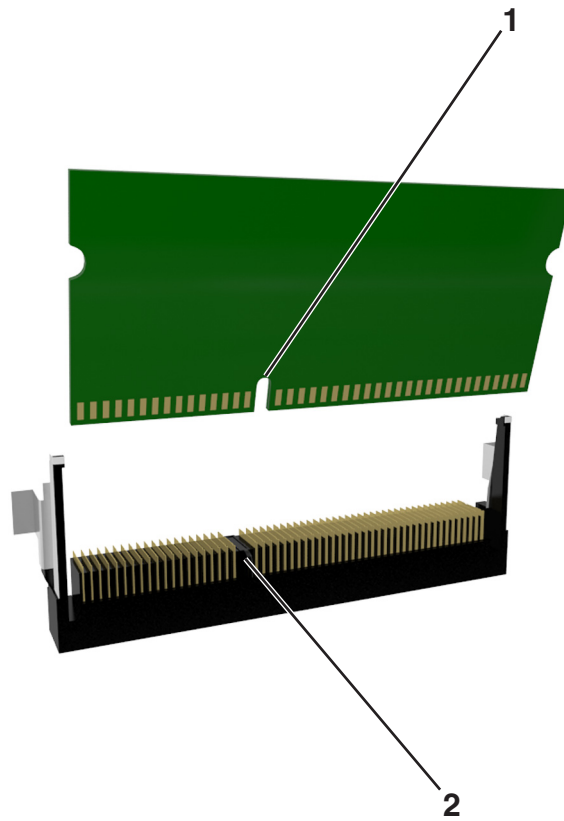

- 4 Push the memory card straight into the connector, and then push the card toward the controller board wall until it *clicks* into place.

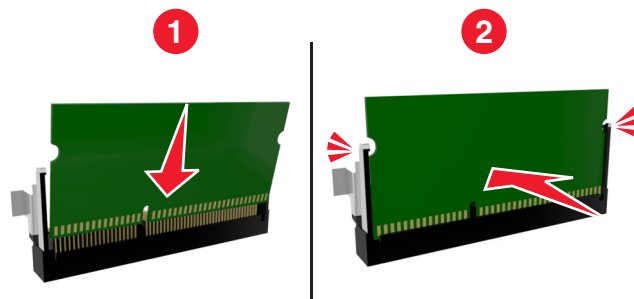

- 5 Close the controller board access door.

Note: When the printer software and any hardware options are installed, it may be necessary to manually add the options in the printer driver to make them available for print jobs. For more information, see “Updating available options in the printer driver” on page 22.

Installing an optional card

⚠ CAUTION—SHOCK HAZARD: If you are accessing the controller board or installing optional hardware or memory devices sometime after setting up the printer, then turn the printer off, and unplug the power cord from the electrical outlet before continuing. If you have other devices attached to the printer, then turn them off as well, and unplug any cables going into the printer.

Warning—Potential Damage: Controller board electronic components are easily damaged by static electricity. Touch a metal surface on the printer before touching any controller board electronic components or connectors.

- 1 Access the controller board.

For more information, see “Accessing the controller board” on page 14.

- 2 Unpack the optional card.

Warning—Potential Damage: Avoid touching the connection points along the edge of the card.

- 3 Holding the card by its sides, align the plastic pins (1) on the card with the holes (2) on the controller board.

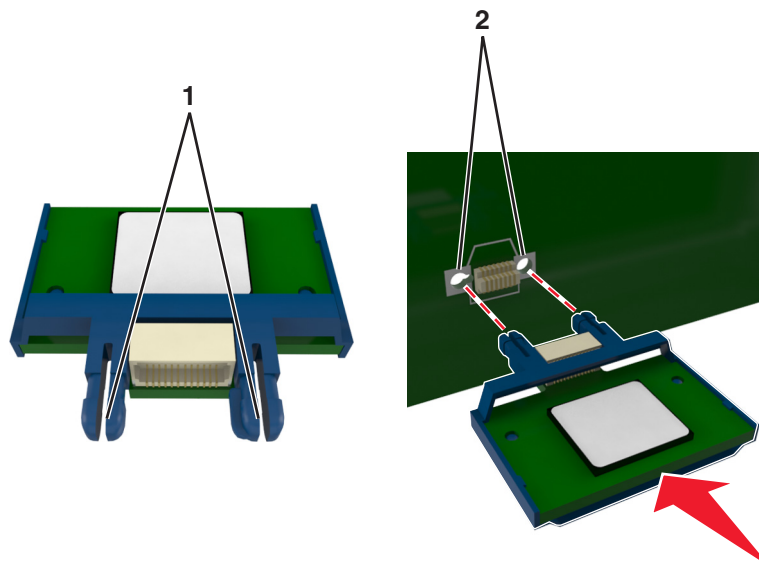

- 4 Push the card firmly into place as shown in the illustration.

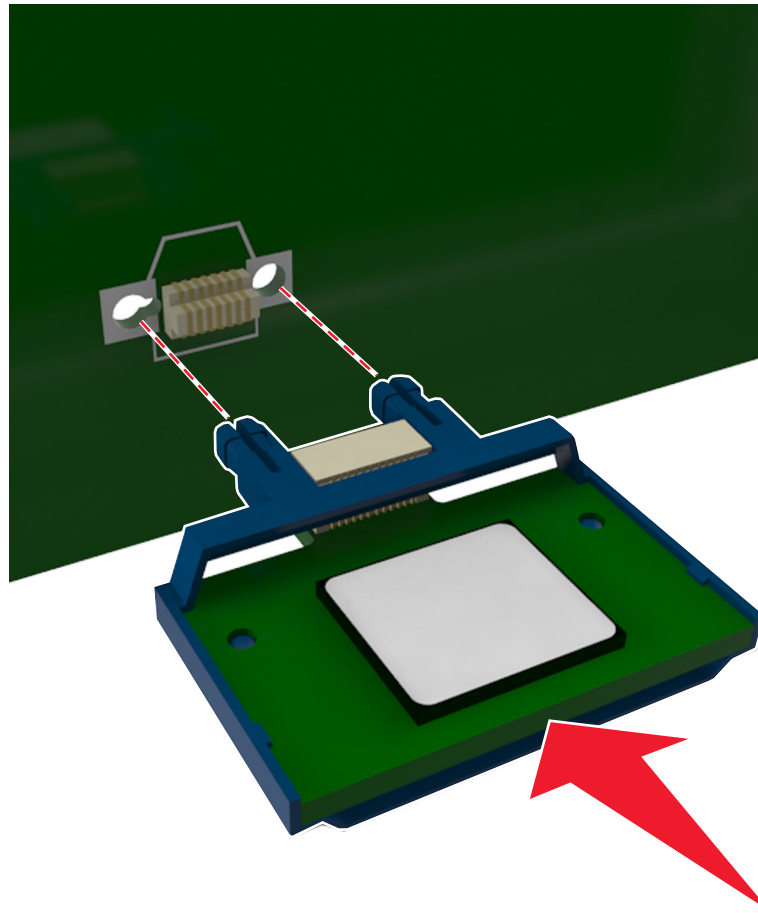

Warning—Potential Damage: Improper installation of the card may cause damage to the card and the controller board.

Note: The entire length of the connector on the card must touch and be flushed against the controller board.

- 5 Close the controller board access door.

Note: When the printer software and any hardware options are installed, it may be necessary to manually add the options in the printer driver to make them available for print jobs. For more information, see “Updating available options in the printer driver” on page 22.

Installing hardware options

Installing optional trays

⚠ CAUTION—SHOCK HAZARD: If you are accessing the controller board or installing optional hardware or memory devices sometime after setting up the printer, then turn the printer off, and unplug the power cord from the electrical outlet before continuing. If you have any other devices attached to the printer, then turn them off as well, and unplug any cables going into the printer.

- 1 Turn off the printer using the power switch, and then unplug the power cord from the electrical outlet.



- 2 Unpack the tray, and then remove any packing material.
- 3 Remove the tray from the base.

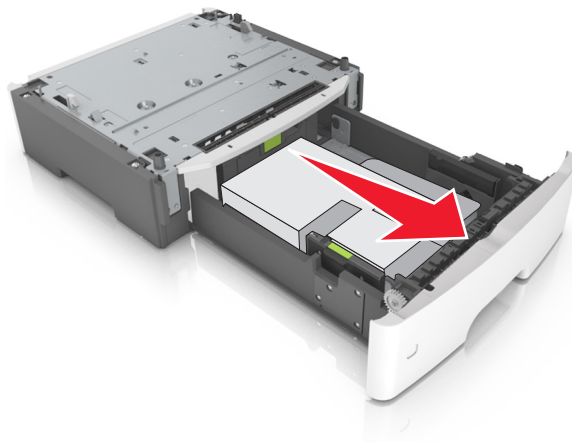

- 4 Remove any packing material from inside the tray.
- 5 Insert the tray into the base.
- 6 Place the tray near the printer.

7 Align the printer with the tray, and then slowly lower the printer into place.



8 Connect the power cord to the printer, then to a properly grounded electrical outlet, and then turn on the printer.



Note: When the printer software and any hardware options are installed, it may be necessary to manually add the options in the printer driver to make them available for print jobs. For more information, see “Updating available options in the printer driver” on page 22.

Attaching cables

Connect the printer to the computer using a USB or parallel cable, or to the network using an Ethernet cable.

Make sure to match the following:

- The USB symbol on the cable with the USB symbol on the printer
- The appropriate parallel cable with the parallel port

- The appropriate Ethernet cable with the Ethernet port

Warning—Potential Damage: Do not touch the USB cable, any network adapter, or the printer in the area shown while actively printing. Loss of data or a malfunction can occur.

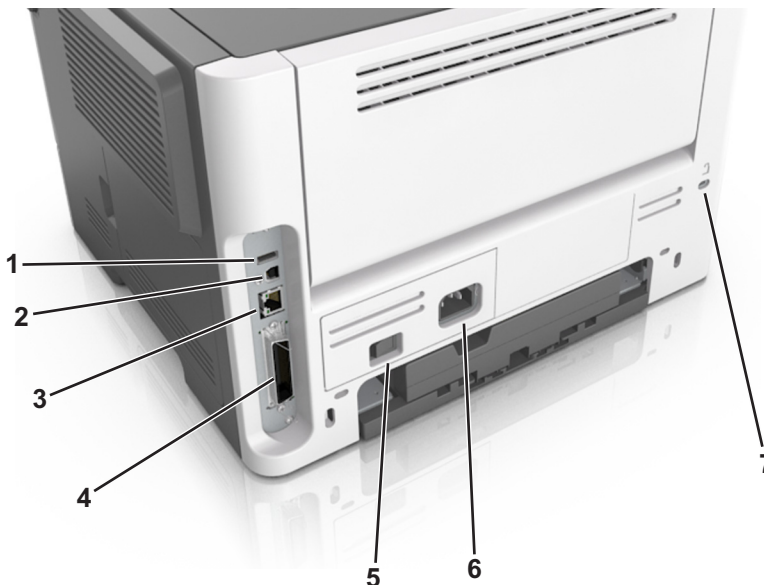

	Use the	To
1	USB port*	Attach an optional wireless network adapter.
2	USB printer port	Connect the printer to a computer.
3	Ethernet port*	Connect the printer to a network.
4	Parallel port*	Connect the printer to a computer.
5	Power switch	Turn on or turn off the printer.
6	Printer power cord socket	Connect the printer to an electrical outlet.
7	Security slot	Attach a lock that will secure the printer in place.

* These ports are available only in select printer models.

Setting up the printer software

Installing the printer software

Note: If you installed the printer software on the computer before but need to reinstall the software, then uninstall the current software first.

For Windows users

- 1 Close all open software programs.
- 2 Insert the *Software and Documentation* CD.

If the installation dialog does not appear after a minute, then launch the CD manually:

- a Click , or click **Start** and then click **Run**.
- b In the Start Search or Run dialog, type **D:\setup.exe**, where **D** is the letter of your CD or DVD drive.
- c Press **Enter**, or click **OK**.

3 Click **Install**, and then follow the instructions on the computer screen.

For Macintosh users

1 Close all open applications.

2 Insert the *Software and Documentation* CD.

If the installation dialog does not appear after a minute, then click the CD icon on the desktop.

3 Double-click the software installer package, and then follow the instructions on the computer screen.

Note: To take advantage of the full features of your printer, select the custom install option, and then select all packages listed.

Using the Internet

1 Go to the Lexmark Web site at <http://support.lexmark.com>.

2 Navigate to:

SUPPORT & DOWNLOADS > select your printer > select your operating system

3 Download the printer driver, and then install the printer software.

Installing the Local Printer Settings Utility

1 Visit <http://support.lexmark.com>, and then download the software.

2 Double-click the downloaded software.

3 Select an installation type, and then click **Install**.

4 Click **Install** to start the installation.

5 Click **Agree** to accept the license agreement.

6 Click **Continue**, and then follow the instructions on the computer screen.

Notes:

- Use the Local Printer Settings Utility to change the toner darkness, power saver, and paper size settings for all print jobs. Use the printer software to change these settings for individual print jobs.
- This utility is supported only in select printer models.

Updating available options in the printer driver

When the printer software and any hardware options are installed, you may need to manually add the options in the printer driver to make them available for print jobs.

For Windows users

- 1 Open the printers folder.
 - a Click , or click **Start** and then click **Run**.
 - b In the Start Search or Run dialog, type **control printers**.
 - c Press **Enter**, or click **OK**.
- 2 Select the printer.
- 3 Right-click the printer, and then select **Properties**.
- 4 Click the **Configuration** tab.
- 5 Do either of the following:
 - Click **Update Now - Ask Printer**.
 - Under Configuration Options, manually add any installed hardware options.
- 6 Click **Apply**.

For Macintosh users

- 1 From the Apple menu, navigate to either of the following:
 - **System Preferences > Print & Scan > select your printer > Options & Supplies > Driver**
 - **System Preferences > Print & Fax > select your printer > Options & Supplies > Driver**
- 2 Add any installed hardware options, and then click **OK**.

Networking

Notes:

- Purchase a MarkNet™ N8352 wireless network adapter first before setting up the printer on a wireless network. For information on installing the wireless network adapter, see the instruction sheet that came with the adapter.
- A *Service Set Identifier* (SSID) is a name assigned to a wireless network. Wired Equivalent Privacy (WEP), Wi-Fi Protected Access (WPA), WPA2, and 802.1X - RADIUS are types of security used on a network.

Preparing to set up the printer on an Ethernet network

To configure your printer to connect to an Ethernet network, organize the following information before you begin:

Note: If your network automatically assigns IP addresses to computers and printers, continue on to installing the printer.

- A valid, unique IP address for the printer to use on the network
- The network gateway
- The network mask
- A nickname for the printer (optional)

Note: A printer nickname can make it easier for you to identify your printer on the network. You can choose to use the default printer nickname, or assign a name that is easier for you to remember.

You will need an Ethernet cable to connect the printer to the network and an available port where the printer can physically connect to the network. Use a new network cable when possible to avoid potential problems caused by a damaged cable.

Installing the printer on an Ethernet network

For Windows users

- 1 Insert the *Software and Documentation* CD.

If the installation dialog does not appear after a minute, then launch the CD manually:

- a Click , or click **Start** and then click **Run**.
- b In the Start Search or Run dialog, type **D:\setup.exe**, where **D** is the letter of the CD or DVD drive.
- c Press **Enter**, or click **OK**.

- 2 Click **Install**, and then follow the instructions on the computer screen.

- 3 Select **Ethernet connection**, and then click **Continue**.

- 4 Attach the Ethernet cable when instructed to do so.

- 5 Select the printer from the list, and then click **Continue**.

Note: If the configured printer does not appear in the list, then click **Modify Search**.

- 6 Follow the instructions on the computer screen.

For Macintosh users

- 1 Allow the network DHCP server to assign an IP address to the printer.

- 2 Obtain the printer IP address either:

- From the printer control panel
- From the TCP/IP section in the Network/Ports menu
- By printing a network setup page or menu settings page, and then finding the TCP/IP section

Note: You will need the IP address if you are configuring access for computers on a different subnet than the printer.

- 3 Install the printer driver on the computer.

- a Insert the *Software and Documentation* CD, and then double-click the installer package for the printer.

- b Follow the instructions on the computer screen.

- c Select a destination, and then click **Continue**.

- d From the Easy Install screen, click **Install**.

- e Type the user password, and then click **OK**.

All the necessary applications are installed on the computer.

- f Click **Close** when installation is complete.

4 Add the printer.

- For IP printing:
 - a From the Apple menu, navigate to either of the following:
 - **System Preferences > Print & Scan**
 - **System Preferences > Print & Fax**
 - b Click +.
 - c Click the **IP** tab.
 - d Type the printer IP address in the address field, and then click **Add**.
- For AppleTalk printing:

Notes:

- Make sure AppleTalk is activated on your printer.
- This feature is supported only in Mac OS X version 10.5.

- a From the Apple menu, navigate to:
System Preferences > Print & Fax
- b Click +, and then navigate to:
AppleTalk > select your printer > Add

Preparing to set up the printer on a wireless network

Notes:

- Make sure your wireless network adapter is installed in your printer and working properly.
- Make sure your access point (wireless router) is turned on and is working properly.

Make sure you have the following information before setting up the printer on a wireless network:

- **SSID**—The SSID is also referred to as the network name.
- **Wireless Mode (or Network Mode)**—The mode is either infrastructure or ad hoc.
- **Channel (for ad hoc networks)**—The channel defaults to automatic for infrastructure networks.

Some ad hoc networks will also require the automatic setting. Check with your system support person if you are not sure which channel to select.

- **Security Method**—There are three basic options for Security Method:

- WEP key

If your network uses more than one WEP key, then enter up to four in the provided spaces. Select the key currently in use on the network by selecting the default WEP transmit key.

or

- WPA or WPA2 preshared key or passphrase

WPA includes encryption as an additional layer of security. The choices are AES or TKIP. Encryption must be set for the same type on the router and on the printer, or the printer will not be able to communicate on the network.

- 802.1X—RADIUS

If you are installing the printer on an 802.1X network, then you may need the following:

- Authentication type
- Inner authentication type

- 802.1X user name and password
 - Certificates
 - No security
- If your wireless network does not use any type of security, then you will not have any security information.

Note: Using an unsecured wireless network is not recommended.

Notes:

- If you do not know the SSID of the network that your computer is connected to, then launch the wireless utility of the computer network adapter, and then look for the network name. If you cannot find the SSID or the security information for your network, then see the documentation that came with the access point, or contact your system support person.
- To find the WPA/WPA2 preshared key/passphrase for the wireless network, see the documentation that came with the access point, see the Web page associated with the access point, or consult your system support person.

Connecting the printer to a wireless network using Wi-Fi Protected Setup

Before connecting the printer to a wireless network, make sure that:

- The access point (wireless router) is Wi-Fi Protected Setup (WPS) certified or WPS-compatible. For more information, see the documentation that came with your access point.
- A wireless network adapter installed in your printer is attached and working properly. For more information, see the instruction sheet that came with the wireless network adapter.

Using the Push Button Configuration method

- 1 From the printer control panel, navigate to:

 > Network/Ports >  > Network [x] >  > Network [x] Setup >  > Wireless >  > Wi-Fi Protected Setup >  > Start Push Button Method > 

- 2 Follow the instructions on the printer display.

Using the Personal Identification Number (PIN) method

- 1 From the printer control panel, navigate to:

 > Network/Ports >  > Network [x] >  > Network [x] Setup >  > Wireless >  > Wi-Fi Protected Setup >  > Start PIN Method > 

- 2 Copy the eight-digit WPS PIN.
- 3 Open a Web browser, and then type the IP address of your access point in the address field.

Notes:

- The IP address appears as four sets of numbers separated by periods, such as 123.123.123.123.
 - If you are using a proxy server, then temporarily disable it to load the Web page correctly.
- 4 Access the WPS settings. For more information, see the documentation that came with your access point.
 - 5 Enter the eight-digit PIN, and then save the setting.

Connecting the printer to a wireless network using the printer software

Using the Wireless Setup Utility (Windows only)

The Wireless Setup Utility lets you:

- Configure the printer to join an existing wireless network.
- Add a printer to an existing ad hoc network.
- Change the wireless settings after installation.
- Install the printer on additional network computers.

Installing the Wireless Setup Utility

- 1 Go to the Lexmark Web site at <http://support.lexmark.com>.
- 2 Download the latest Wireless Setup Utility.
- 3 Double-click the downloaded software installer package.
- 4 Follow the instructions on the computer screen.

Launching the Wireless Setup Utility

Notes:

- Make sure the printer is turned on.
- Make sure a wireless network adapter installed in your printer is attached and working properly.

- 1 Click  or **Start**.
- 2 Click **All Programs** or **Programs**, and then select the printer program folder from the list.
- 3 Select your printer, and then navigate to:
Printer Home > Settings > Wireless Setup Utility
- 4 Follow the instructions on the computer screen.

Using the Wireless Setup Assistant (Macintosh only)

The Wireless Setup Assistant lets you:

- Configure the printer to join an existing wireless network.
- Add a printer to an existing ad hoc network.
- Change the wireless settings after installation.
- Install the printer on additional network computers.

Installing the Wireless Setup Assistant

- 1 Go to the Lexmark Web site at <http://support.lexmark.com>.
- 2 Download the latest Wireless Setup Assistant application.
- 3 Double-click the downloaded software installer package.
- 4 Follow the instructions on the computer screen.

Launching the Wireless Setup Assistant

Notes:

- Make sure the printer is turned on.
- Make sure a wireless network adapter installed in your printer is attached and working properly.

1 From the Finder, navigate to:

Applications > select your printer folder

2 Double-click **Wireless Setup Assistant**, and then follow the instructions on the computer screen.

Note: If you encounter problems while running the application, then click .

Connecting the printer to a wireless network using the Embedded Web Server

Before you begin, make sure that:

- Your printer is connected temporarily to an Ethernet network.
- A wireless network adapter is installed in your printer and working properly. For more information, see the instruction sheet that came with your wireless network adapter.

1 Open a Web browser, and then type the printer IP address in the address field.

Notes:

- View the printer IP address on the printer control panel. The IP address appears as four sets of numbers separated by periods, such as 123.123.123.123.
- If you are using a proxy server, then temporarily disable it to load the Web page correctly.

2 Click **Settings** > **Network/Ports** > **Wireless**.

3 Modify the settings to match the settings of your access point (wireless router).

Note: Make sure to enter the correct SSID.

4 Click **Submit**.

5 Turn off the printer, and then disconnect the Ethernet cable. Then wait for at least five seconds, and then turn the printer back on.

6 To verify if your printer is connected to the network, print a network setup page. Then in the Network Card [x] section, see if the status is Connected.

Verifying printer setup

Printing a menu settings page

Print a menu settings page to review the current menu settings and to verify if the printer options are installed correctly.

Note: If you have not changed any menu settings, then the menu settings page lists all the factory default settings. When you select and save other settings from the menus, they replace the factory default settings as *user default settings*. A user default setting remains in effect until you access the menu again, choose another value, and save it.

From the printer control panel, navigate to:

 > Reports >  > Menu Settings Page > 

Printing a network setup page

If the printer is connected to a network, then print a network setup page to verify the network connection. This page also provides important information that aids network printing configuration.

- 1 From the printer control panel, navigate to:

 > Reports >  > Network Setup Page > 

Note: If an optional print server is installed, then **Print Network [x] Setup Page** appears.

- 2 Check the first section of the network setup page and confirm that the status is Connected.

If the status is Not Connected, then the LAN drop may not be active, or the network cable may be malfunctioning. Consult your system support person for a solution, and then print another network setup page.

Loading paper and specialty media

The selection and handling of paper and specialty media can affect how reliably documents print. For more information, see “Avoiding jams” on page 103 and “Storing paper” on page 46.

Setting the paper size and type

1 From the printer control panel, navigate to:

 > Paper Menu >  > Paper Size/Type > 

2 Select **Tray [x] Size** or **Tray [x] Type**, and then press .

3 Change the paper size or type setting, and then press .

Notes:

- The paper size setting for the standard 250-sheet tray (Tray 1), optional 250- or 550-sheet tray (Tray 2), and the multipurpose feeder must be set manually in the Paper Size menu.
- The factory default paper type for Tray 1 is Plain Paper.
- The factory default paper type for the multipurpose feeder is Custom Type 6.
- The paper type setting must be manually set for all trays.

Configuring Universal paper settings

The Universal paper size is a user-defined setting that lets you print on paper sizes that are not preset in the printer menus.

Notes:

- The largest supported Universal size is 216 x 355.6 mm (8.5 x 14 inches).
- The smallest Universal size supported in the multipurpose feeder is 76 x 127 mm (3 x 5 inches). The smallest Universal size supported in the optional tray is 183 x 210 mm (7.2 x 8.3 inches).

From the printer control panel, navigate to:

 > Paper Menu >  > Universal Setup >  > Units of Measure >  > select the unit of measure > 

Specify the paper height and width

1 From the printer control panel, navigate to:

 > Paper Menu >  > Universal Setup >  > Units of Measure >  > select the unit of measure > 

2 Press the arrow buttons until **Portrait Height** or **Portrait Width** appears, and then press .

- 3 Change the settings, and then press .

Using the standard bin and paper stop

The standard bin holds up to 150 sheets of 20-lb paper. It collects prints facedown. The standard bin includes a paper stop that keeps paper from sliding out the front of the bin as it stacks.

To open the paper stop, pull it so that it flips forward.

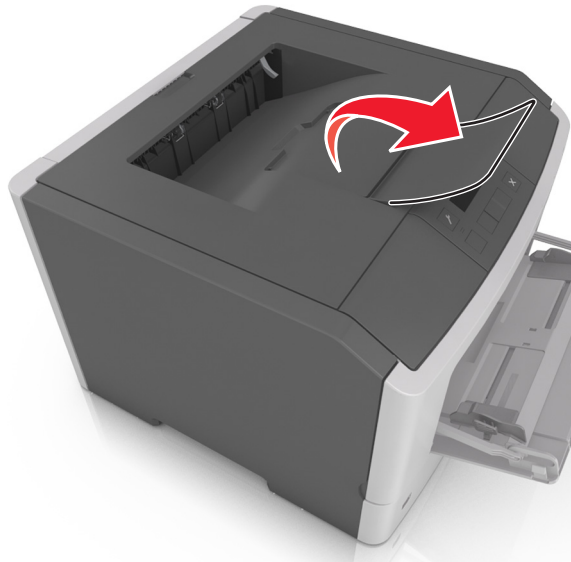

Note: Close the paper stop when moving the printer to another location.

Loading trays

 **CAUTION—POTENTIAL INJURY:** To reduce the risk of equipment instability, load each tray separately. Keep all other trays closed until needed.

- 1 Pull the tray completely out.

Note: Do not remove trays while a job prints or while **Busy** appears on the printer display. Doing so may cause a jam.



2 Squeeze, and then slide the width guide tab to the correct position for the size of the paper you are loading.

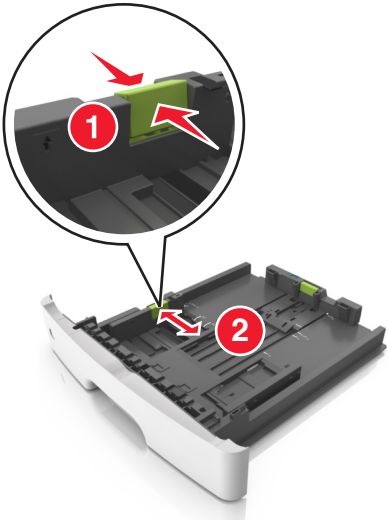

- 3 Unlock the length guide. Squeeze, and then slide the length guide tab to the correct position for the size of the paper you are loading.

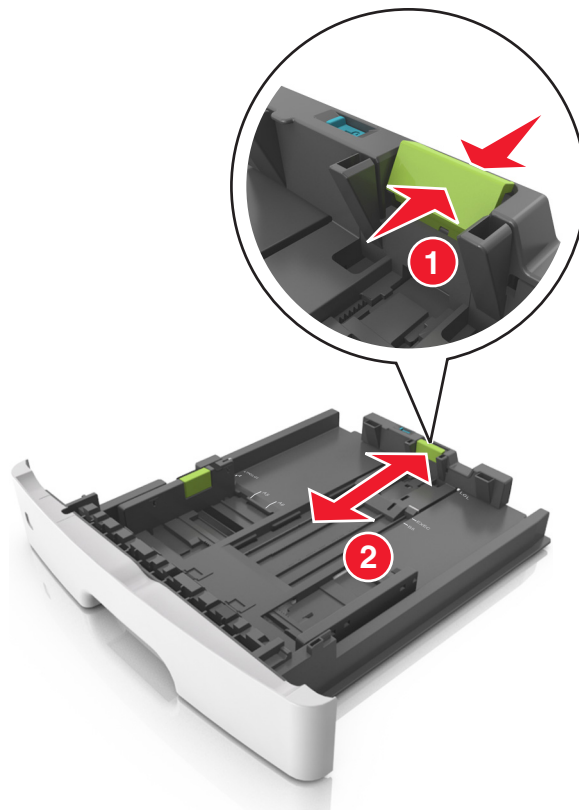
**Notes:**

- For some paper sizes like letter, legal, and A4, squeeze and slide the length guide tab backward to accommodate their length.
- When loading legal-size paper, the length guide extends beyond the base leaving the paper exposed to dust. To protect the paper from dust, you can purchase a dust cover separately. For more information, contact customer support.
- If you are loading A6-size paper in the standard tray, then squeeze and then slide the length guide tab toward the center of the tray to the A6-size position.
- Make sure the width and length guides are aligned with the paper size indicators on the bottom of the tray.

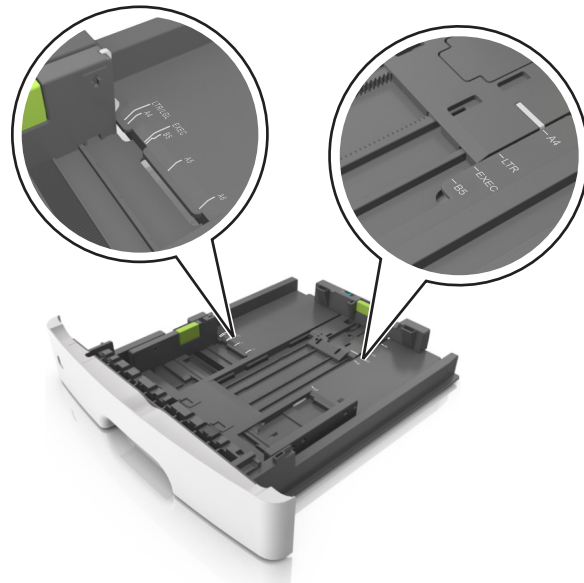

- 4 Flex the sheets back and forth to loosen them, and then fan them. Do not fold or crease the paper. Straighten the edges on a level surface.

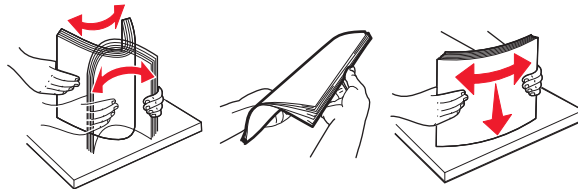

- 5 Load the paper stack.



Notes:

- Load with the printable side facedown when using recycled or preprinted paper.
- Load prepunched paper with the holes on the top edge toward the front of the tray.

- Load letterhead facedown, with the top edge of the sheet toward the front of the tray. For two-sided printing, load letterhead faceup with the bottom edge of the sheet toward the front of the tray.
- Make sure the paper is below the maximum paper fill indicator located on the side of the width guide.

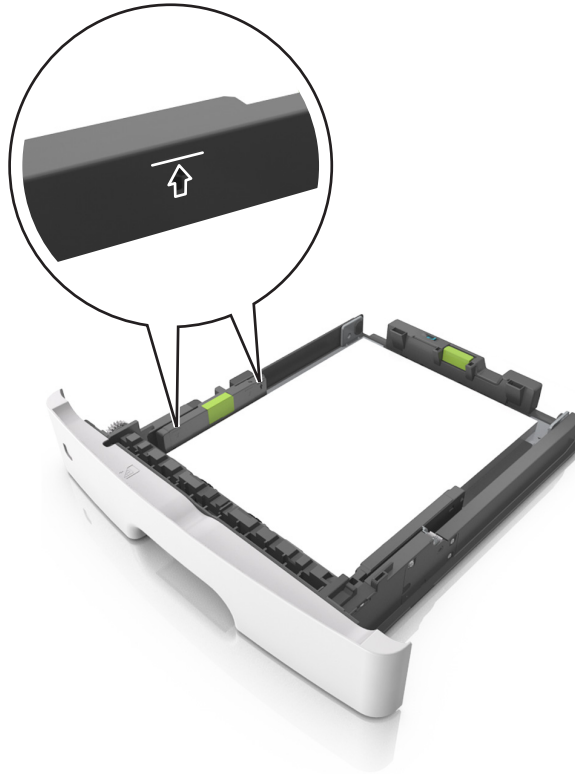

6 Insert the tray.



7 From the printer control panel, set the paper size and type in the Paper menu to match the paper loaded in the tray.

Note: Set the correct paper size and type to avoid paper jams and print quality problems.

Loading the multipurpose feeder

Use the multipurpose feeder when printing on different paper sizes and types or specialty media, such as card stock, transparencies, paper labels, and envelopes. You can also use it for single-page print jobs on letterhead.

- 1 Open the multipurpose feeder.

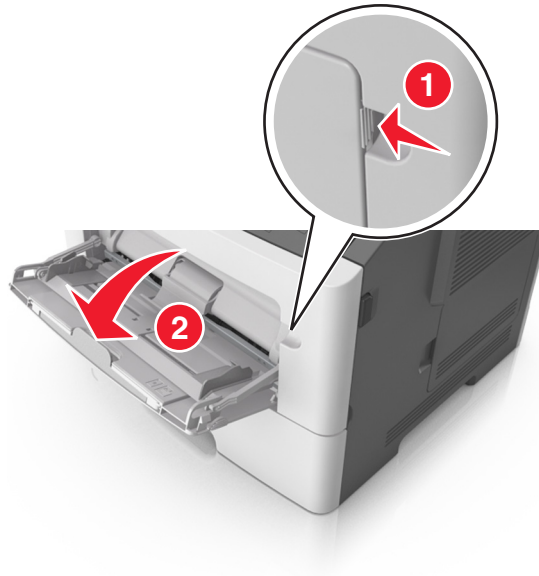

- a Pull the multipurpose feeder extender.



- b Pull the extender gently so that the multipurpose feeder is fully extended and open.



- 2 Squeeze the tab on the left width guide, and then move the guides for the paper you are loading.

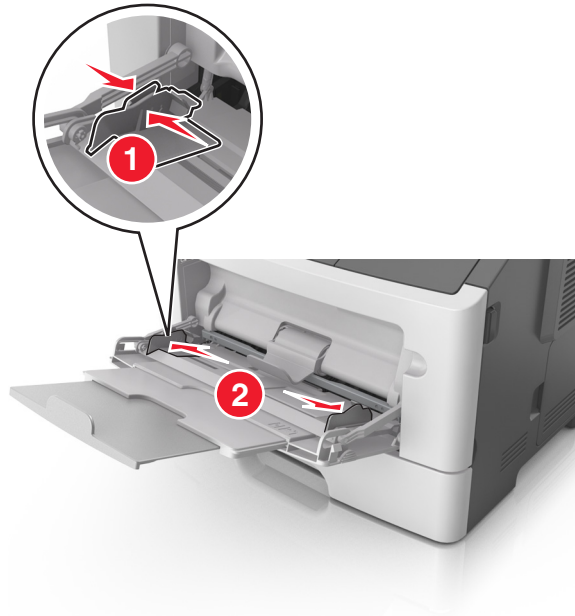

- 3 Prepare the paper or specialty media for loading.

- Flex sheets of paper back and forth to loosen them, and then fan them. Do not fold or crease the paper. Straighten the edges on a level surface.

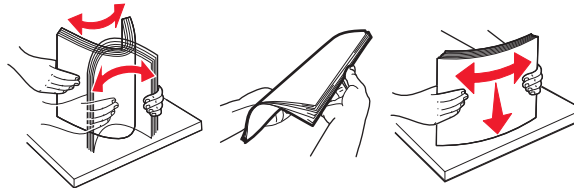

- Hold transparencies by the edges. Flex the stack of transparencies back and forth to loosen them, and then fan them. Straighten the edges on a level surface.

Note: Avoid touching the printable side of the transparencies. Be careful not to scratch them.

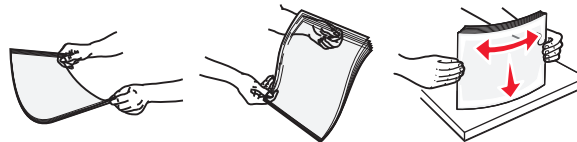

- Flex the stack of envelopes back and forth to loosen them, and then fan them. Straighten the edges on a level surface.



- 4 Load the paper or specialty media.

Note: Make sure the paper or specialty media is below the maximum paper fill indicator located on the paper guides. Overfilling may cause paper jams.

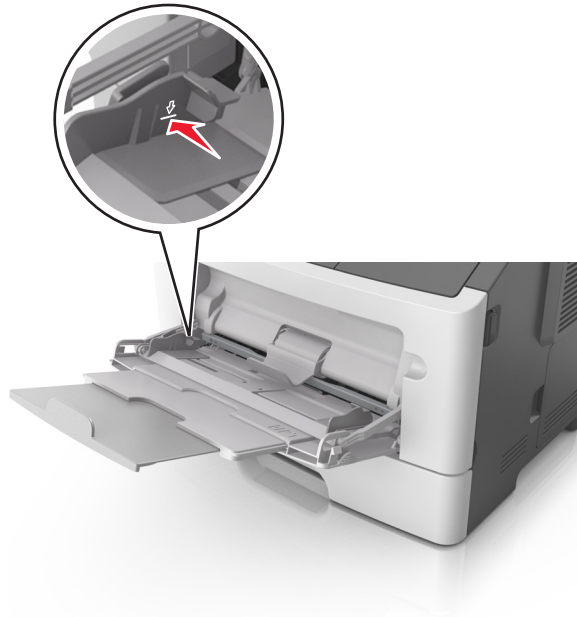

- Load paper, transparencies, and card stock with the recommended printable side faceup and the top edge entering the printer first. For more information on loading transparencies, see the packaging that the transparencies came in.

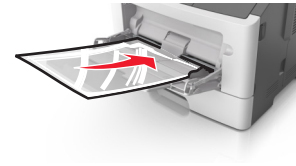
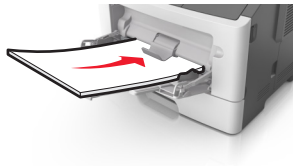

- Load letterhead faceup with the top edge entering the printer first. For two-sided (duplex) printing, load letterhead facedown with the bottom edge entering the printer first.



- Load envelopes with the flap on the left side facedown.



Warning—Potential Damage: Never use envelopes with stamps, clasps, snaps, windows, coated linings, or self-stick adhesives. These envelopes may severely damage the printer.

- 5 From the printer control panel, set the paper size and type in the Paper menu to match the paper or specialty media loaded in the multipurpose feeder.

Linking and unlinking trays

When the paper size and paper type for any trays are the same, the printer will link those trays. When one linked tray becomes empty, paper will feed from the next linked tray. It is recommended to give all unique paper, such as letterhead and different colored plain papers, a different custom type name so that the trays they are in will not automatically link.

Linking and unlinking trays

Using the Embedded Web Server

- 1 Open a Web browser, and then type the printer IP address in the address field.

Notes:

- View the printer IP address in the TCP/IP section in the Network/Ports menu. The IP address appears as four sets of numbers separated by periods, such as 123.123.123.123.
- If you are using a proxy server, then temporarily disable it to load the Web page correctly.

- 2 Click **Settings > Paper Menu**.

- 3 Change the tray settings to specify the paper size and type for the tray.

- To link trays, make sure the paper size and type for the tray match with that of the other tray.
- To unlink trays, make sure the paper size or type for the tray does *not* match with that of the other tray.

- 4 Click **Submit**.

Using the printer settings on the computer

Depending on your operating system, access the Paper menu using the Local Printer Settings Utility or Printer Settings.

Note: You can also specify the paper size and type for the tray using the printer control panel. For more information, see “Setting the paper size and type” on page 30.

Warning—Potential Damage: Paper loaded in the tray should match the paper type name assigned in the printer. The temperature of the fuser varies according to the specified paper type. Printing issues may occur if settings are not properly configured.

Configuring a custom paper type name

Using the Embedded Web Server

- 1 Open a Web browser, and then type the printer IP address in the address field.

Notes:

- Print a network setup page or menu settings page, and then locate the IP address in the TCP/IP section. The IP address appears as four sets of numbers separated by periods, such as 123.123.123.123.
- If you are using a proxy server, then temporarily disable it to load the Web page correctly.

- 2 Click **Settings > Paper Menu > Custom Names**.
- 3 Select a custom name, and then type a new custom paper type name.
- 4 Click **Submit**.
- 5 Click **Custom Types**, and then verify if the new custom paper type name has replaced the custom name.

Using the printer settings on the computer (Windows only)

Access the Custom menu using the Local Printer Settings Utility.

Configuring a custom paper type

Using the Embedded Web Server

- 1 Open a Web browser, and then type the printer IP address in the address field.

Notes:

- Print a network setup page or menu settings page, and then locate the IP address in TCP/IP section. The IP address appears as four sets of numbers separated by periods, such as 123.123.123.123.
- If you are using a proxy server, then temporarily disable it to load the Web page correctly.

- 2 Click **Settings > Paper Menu > Custom Types**.
- 3 Select a custom paper type name, and then select a custom paper type.

Note: Plain Paper is the factory default paper type for all user-defined custom names.

- 4 Click **Submit**.

Using the printer settings on the computer

Depending on your operating system, access the Custom menu using the Local Printer Settings Utility or Printer Settings.

Assigning a custom paper type

Using the Embedded Web Server

- 1 Open a Web browser, and then type the printer IP address in the address field.

Notes:

- Print a network setup page or menu settings page, and then locate the IP address in the TCP/IP section. The IP address appears as four sets of numbers separated by periods, such as 123.123.123.123.
- If you are using a proxy server, then temporarily disable it to load the Web page correctly.

- 2 Click **Settings > Paper Menu**.

- 3 From the Tray Configuration section, select a paper source, and then select a custom paper type under the paper type column.

- 4 Click **Submit**.

Using the printer settings on the computer

Depending on your operating system, access the Paper menu using the Local Printer Settings Utility or Printer Settings.

Paper and specialty media guide

Additional information for printing on specialty media may be found in the *Card Stock and Label Guide* available at <http://support.lexmark.com>.

Paper guidelines

Selecting the correct paper or specialty media reduces printing problems. For the best print quality, try a sample of the paper or specialty media before buying large quantities.

Paper characteristics

The following paper characteristics affect print quality and reliability. Consider these characteristics when evaluating new paper stock.

Weight

The standard printer trays can automatically feed paper weights up to 90-g/m² (24-lb) bond grain long paper. The optional trays can automatically feed paper weights up to 120-g/m² (32-lb) bond grain long paper. The multipurpose feeder can automatically feed paper weights up to 163-g/m² (43-lb) bond grain long paper. Paper lighter than 60 g/m² (16 lb) might not be stiff enough to feed properly, causing jams. For best performance, use 75-g/m² (20-lb) bond grain long paper. For paper smaller than 182 x 257 mm (7.2 x 10.1 inches), it is recommended to use 90 g/m² (24 lb) or heavier paper.

Note: Two-sided printing is supported only for 60–90-g/m² (16–24-lb) bond paper.

Curl

Curl is the tendency for paper to curl at its edges. Excessive curl can cause paper feeding problems. Curl can occur after the paper passes through the printer, where it is exposed to high temperatures. Storing paper unwrapped in hot, humid, cold, or dry conditions, even in the trays, can contribute to paper curling prior to printing and can cause feeding problems.

Smoothness

Paper smoothness directly affects print quality. If paper is too rough, toner cannot fuse to it properly. If paper is too smooth, it can cause paper feeding or print quality issues. Always use paper between 100 and 300 Sheffield points; smoothness between 150–250 Sheffield points produces the best print quality.

Moisture content

The amount of moisture in paper affects both print quality and the ability of the printer to feed the paper correctly. Leave paper in its original wrapper until it is time to use it. This limits the exposure of paper to moisture changes that can degrade its performance.

Condition paper before printing by storing it in its original wrapper in the same environment as the printer for 24–48 hours before printing. Extend the time to several days if the storage or transportation environment is very different from the printer environment. Thick paper may also require a longer conditioning period.

Grain direction

Grain refers to the alignment of the paper fibers in a sheet of paper. Grain is either *grain long*, running the length of the paper, or *grain short*, running the width of the paper.

For 60–90-g/m² (16–24-lb) bond paper, grain long paper is recommended.

Fiber content

Most high-quality xerographic paper is made from 100% chemically treated pulped wood. This content provides the paper with a high degree of stability resulting in fewer paper feeding problems and better print quality. Paper containing fibers such as cotton can negatively affect paper handling.

Unacceptable paper

The following paper types are not recommended for use with the printer:

- Chemically treated papers used to make copies without carbon paper, also known as carbonless papers, carbonless copy paper (CCP), or no carbon required (NCR) paper
- Preprinted papers with chemicals that may contaminate the printer
- Preprinted papers that can be affected by the temperature in the printer fuser
- Preprinted papers that require a registration (the precise print location on the page) less than ±2.5 mm (±0.10 inch), such as optical character recognition (OCR) forms

In some cases, registration can be adjusted with a software application to successfully print on these forms:

- Coated papers (erasable bond), synthetic papers, thermal papers
- Rough-edged, rough or heavily textured surface papers, or curled papers
- Recycled papers that fail EN12281:2002 (European)
- Paper weighing less than 60 g/m² (16 lb)
- Multiple-part forms or documents

Selecting paper

Using the appropriate paper prevents jams and helps ensure trouble-free printing.

To help avoid paper jams and poor print quality:

- *Always* use new, undamaged paper.
- Before loading paper, know the recommended printable side of the paper. This information is usually indicated on the paper package.
- *Do not* use paper that has been cut or trimmed by hand.
- *Do not* mix paper sizes, types, or weights in the same tray; mixing results in jams.
- *Do not* use coated papers unless they are specifically designed for electrophotographic printing.

Selecting preprinted forms and letterhead

Use these guidelines when selecting preprinted forms and letterhead:

- Use grain long for 60 to 90 g/m² (16 to 24 lb) weight paper.
- Use only forms and letterhead printed using an offset lithographic or engraved printing process.

- Avoid papers with rough or heavily textured surfaces.

Use papers printed with heat-resistant inks designed for use in xerographic copiers. The ink must be able to withstand temperatures up to 230°C (446°F) without melting or releasing hazardous emissions. Use inks that are not affected by the resin in toner. Inks that are oxidation-set or oil-based generally meet these requirements; latex inks might not. When in doubt, contact the paper supplier.

Preprinted papers such as letterhead must be able to withstand temperatures up to 230°C (446°F) without melting or releasing hazardous emissions.

Using recycled paper and other office papers

As an environmentally conscious company, Lexmark supports the use of recycled office paper produced specifically for use in laser (electrophotographic) printers. In 1998, Lexmark presented to the US government a study demonstrating that recycled paper produced by major mills in the US fed as well as non-recycled paper. However, no blanket statement can be made that *all* recycled paper will feed well.

Lexmark consistently tests its printers with recycled paper (20–100% post-consumer waste) and a variety of test paper from around the world, using chamber tests for different temperature and humidity conditions. Lexmark has found no reason to discourage the use of today's recycled office papers, but generally the following property guidelines apply to recycled paper.

- Low moisture content (4–5%)
- Suitable smoothness (100–200 Sheffield units, or 140–350 Bendtsen units, European)

Note: Some much smoother papers (such as premium 24 lb laser papers, 50–90 Sheffield units) and much rougher papers (such as premium cotton papers, 200–300 Sheffield units) have been engineered to work very well in laser printers, despite surface texture. Before using these types of paper, consult your paper supplier.

- Suitable sheet-to-sheet coefficient of friction (0.4–0.6)
- Sufficient bending resistance in the direction of feed

Recycled paper, paper of lower weight (<60 g/m² [16 lb bond]) and/or lower caliper (<3.8 mils [0.1 mm]), and paper that is cut grain-short for portrait (or short-edge) fed printers may have lower bending resistance than is required for reliable paper feeding. Before using these types of paper for laser (electrophotographic) printing, consult your paper supplier. Remember that these are general guidelines only and that paper meeting these guidelines may still cause paper feeding problems in any laser printer (for example, if the paper curls excessively under normal printing conditions).

Using specialty media

Tips on using card stock

Card stock is heavy, single-ply specialty media. Many of its variable characteristics, such as moisture content, thickness, and texture, can significantly impact print quality. Print samples on the card stock being considered for use before buying large quantities.

When printing on card stock:

- Make sure the Paper Type is Card Stock.
- Select the appropriate Paper Texture setting.
- Be aware that preprinting, perforation, and creasing may significantly affect the print quality and cause jams or other paper handling problems.

- Check with the manufacturer or vendor to ensure that the card stock can withstand temperatures up to 240°C (464°F) without releasing hazardous emissions.
- Do not use preprinted card stock manufactured with chemicals that may contaminate the printer. Preprinting introduces semi-liquid and volatile components into the printer.
- Use grain short card stock when possible.

Tips on using envelopes

Print samples on the envelopes being considered for use before buying large quantities.

- Use envelopes designed specifically for laser printers. Check with the manufacturer or vendor to ensure that the envelopes can withstand temperatures up to 230°C (446°F) without sealing, wrinkling, curling excessively, or releasing hazardous emissions.
- For best performance, use envelopes made from 90-g/m² (24-lb bond) paper or 25% cotton. All-cotton envelopes must not exceed 70-g/m² (20-lb bond) weight.
- Use only new envelopes from undamaged packages.
- To optimize performance and minimize jams, do not use envelopes that:
 - Have excessive curl or twist
 - Are stuck together or damaged in any way
 - Have windows, holes, perforations, cutouts, or embossing
 - Have metal clasps, string ties, or folding bars
 - Have an interlocking design
 - Have postage stamps attached
 - Have any exposed adhesive when the flap is in the sealed or closed position
 - Have bent corners
 - Have rough, cockle, or laid finishes
- Adjust the width guides to fit the width of the envelopes.

Note: A combination of high humidity (over 60%) and high printing temperature may wrinkle or seal envelopes.

Tips on using labels

Print samples on the labels being considered for use before buying large quantities.

Note: Use only paper label sheets. Vinyl, pharmacy, and two-sided labels are not supported.

For more information on label printing, characteristics, and design, see the *Card Stock & Label Guide* available at <http://support.lexmark.com>.

When printing on labels:

- Use labels designed specifically for laser printers. Check with the manufacturer or vendor to verify that:
 - The labels can withstand temperatures up to 240°C (464°F) without sealing, excessive curling, wrinkling, or releasing hazardous emissions.
 - Label adhesives, face sheet (printable stock), and topcoats can withstand up to 25-psi (172-kPa) pressure without delaminating, oozing around the edges, or releasing hazardous fumes.
- Do not use labels with slick backing material.

- Use full label sheets. Partial sheets may cause labels to peel off during printing, resulting in a jam. Partial sheets also contaminate the printer and the cartridge with adhesive, and could void the printer and toner cartridge warranties.
- Do not use labels with exposed adhesive.
- Do not print within 1 mm (0.04 inch) of the edge of the label, of the perforations, or between die-cuts of the label.
- Make sure the adhesive backing does not reach to the edge of the sheet. Zone coating of the adhesive should be at least 1 mm (0.04 inch) away from edges. Adhesive material contaminates the printer and could void the warranty.
- If zone coating of the adhesive is not possible, then remove a 2-mm (0.06-inch) strip on the leading and driver edge, and then use a non-oozing adhesive.
- Portrait orientation is recommended, especially when printing bar codes.

Tips on using letterhead

- Use letterhead designed specifically for laser printers.
- Print samples on the letterhead being considered for use before buying large quantities.
- Before loading letterhead, flex, fan, and straighten the stack to prevent sheets from sticking together.
- Page orientation is important when printing on letterhead. For information on how to load letterhead, see:
 - “Loading trays” on page 31
 - “Loading the multipurpose feeder” on page 36

Tips on using transparencies

- Print a test page on the transparencies being considered for use before buying large quantities.
- Feed transparencies from the standard tray, or the multipurpose feeder.
- Use transparencies designed specifically for laser printers. Transparencies must be able to withstand temperatures up to 185°C (365°F) without melting, discoloring, offsetting, or releasing hazardous emissions.
Note: If the transparency weight is set to Heavy and the transparency texture is set to Rough in the Paper menu, then transparencies can be printed at a temperature up to 195°C (383°F).
- Avoid getting fingerprints on the transparencies to prevent print quality problems.
- Before loading transparencies, flex, fan, and straighten the stack to prevent sheets from sticking together.

Storing paper

Use these paper storage guidelines to help avoid jams and uneven print quality:

- For best results, store paper where the temperature is 21°C (70°F) and the relative humidity is 40 percent. Most label manufacturers recommend printing in a temperature range of 18–24°C (65–75°F) with relative humidity between 40 and 60 percent.
- Store paper in cartons, on a pallet or shelf, rather than on the floor.
- Store individual packages on a flat surface.
- Do not store anything on top of individual paper packages.
- Take paper out of the carton or wrapper only when you are ready to load it in the printer. The carton and wrapper help keep the paper clean, dry, and flat.

Supported paper sizes, types, and weights

For information on card stock and labels, see the *Card Stock & Label Guide*.

Supported paper sizes

Note: For an unlisted paper size, select the closest *larger* listed size. For information on card stock and labels, see the *Card Stock & Label Guide*.

Paper size	Standard tray	Optional 250- or 550-sheet tray	Multipurpose feeder	Duplex mode
A4 210 x 297 mm (8.3 x 11.7 in.)	✓	✓	✓	✓
A5 148 x 210 mm (5.8 x 8.3 in.)	✓	✓	✓	X
A6 105 x 148 mm (4.1 x 5.8 in.)	✓	X	✓	X
JIS B5 182 x 257 mm (7.2 x 10.1 in.)	✓	✓	✓	X
Letter 216 x 279 mm (8.5 x 11 in.)	✓	✓	✓	✓
Legal 216 x 356 mm (8.5 x 14 in.)	✓	✓	✓	✓
Executive 184 x 267 mm (7.3 x 10.5 in.)	✓	✓	✓	X
Oficio (Mexico)¹ 216 x 340 mm (8.5 x 13.4 in.)	✓	✓	✓	✓
Folio 216 x 330 mm (8.5 x 13 in.)	✓	✓	✓	✓
Statement 140 x 216 mm (5.5 x 8.5 in.)	✓	✓	✓	X
Universal² 76.2 x 127 mm (3 x 5 in.) up to 216 x 356 mm (8.5 x 14 in.)	✓	✓	✓	✓
7 3/4 Envelope (Monarch) 98 x 191 mm (3.9 x 7.5 in.)	X	X	✓	X

¹ This size setting formats the page for 216 x 356 mm (8.5 x 14 in.) unless the size is specified by the software application.

² Universal is supported only in the standard tray if the paper size is at least 105 x 148 mm (4.1 x 5.8 in.). Universal is supported only in the optional 250- or 550-sheet tray if the paper size is at least 148 x 210 mm (5.8 x 8.3 in.). Universal is only supported in duplex mode if the width is at least 210 mm (8.3 in.) and length is at least 279 mm (11 in.). The smallest supported Universal size is only supported in the multipurpose feeder.

Paper size	Standard tray	Optional 250- or 550-sheet tray	Multipurpose feeder	Duplex mode
9 Envelope 98 x 225 mm (3.9 x 8.9 in.)	X	X	✓	X
10 Envelope 105 x 241 mm (4.1 x 9.5 in.)	X	X	✓	X
DL Envelope 110 x 220 mm (4.3 x 8.7 in.)	X	X	✓	X
C5 Envelope 162 x 229 mm (6.4 x 9 in.)	X	X	✓	X
B5 Envelope 176 x 250 mm (6.9 x 9.8 in.)	X	X	✓	X
Other Envelope 229 x 356 mm (9 x 14 in.)	X	X	✓	X

¹ This size setting formats the page for 216 x 356 mm (8.5 x 14 in.) unless the size is specified by the software application.

² Universal is supported only in the standard tray if the paper size is at least 105 x 148 mm (4.1 x 5.8 in.). Universal is supported only in the optional 250- or 550-sheet tray if the paper size is at least 148 x 210 mm (5.8 x 8.3 in.). Universal is only supported in duplex mode if the width is at least 210 mm (8.3 in.) and length is at least 279 mm (11 in.). The smallest supported Universal size is only supported in the multipurpose feeder.

Supported paper types and weights

The standard tray supports 60–90-g/m² (16–24-lb) paper weights. The optional tray supports 60–120-g/m² (16–32-lb) paper weights. The multipurpose feeder supports 60–163-g/m² (16–43-lb) paper weights.

Paper type	250- or 550-sheet tray	Multipurpose feeder	Duplex mode
Plain paper	✓	✓	✓
Card stock	X	✓	X
Transparencies	✓	✓	X
Recycled	✓	✓	✓
Glossy paper	X	X	X
Paper labels¹	✓	✓	X
Vinyl labels	X	X	X
Bond²	✓	✓	✓
Envelope	X	✓	X
Rough envelope	X	✓	X

Paper type	250- or 550-sheet tray	Multipurpose feeder	Duplex mode
Letterhead	✓	✓	✓
Preprinted	✓	✓	✓
Colored Paper	✓	✓	✓
Light Paper	✓	✓	✓
Heavy Paper ²	✓	✓	✓
Rough/Cotton	✓	✓	x

¹ One-sided paper labels designed for laser printers are supported for occasional use. It is recommended to print 20 or fewer pages of paper labels per month. Vinyl, pharmacy, and two-sided labels are not supported.

² Bond and Heavy Paper are supported in duplex mode up to 90-g/m² (24-lb) paper weight.

Printing

This chapter covers printing, printer reports, and job cancelation. Selection and handling of paper and specialty media can affect how reliably documents print. For more information, see “Avoiding jams” on page 103 and “Storing paper” on page 46.

Printing a document

Printing a document

- 1 From the Paper menu on the printer control panel, set the paper type and size to match the paper loaded.
- 2 Send the print job:

For Windows users

- a With a document open, click **File > Print**.
- b Click **Properties, Preferences, Options, or Setup**.
- c Adjust the settings, if necessary.
- d Click **OK > Print**.

For Macintosh users

- a Customize the settings in the Page Setup dialog:
 - 1 With a document open, choose **File > Page Setup**.
 - 2 Choose a paper size or create a custom size to match the paper loaded.
 - 3 Click **OK**.
- b Customize the settings in the Print dialog:
 - 1 With a document open, choose **File > Print**.
If necessary, click the disclosure triangle to see more options.
 - 2 From the Print dialog and pop-up menus, adjust the settings if necessary.
Note: To print on a specific paper type, adjust the paper type setting to match the paper loaded, or select the appropriate tray or feeder.
 - 3 Click **Print**.

Adjusting toner darkness

Using the Embedded Web Server

- 1 Open a Web browser, and then type the printer IP address in the address field.

Notes:

- View the printer IP address in the TCP/IP section in the Network/Ports menu. The IP address appears as four sets of numbers separated by periods, such as 123.123.123.123.

- If you are using a proxy server, then temporarily disable it to load the Web page correctly.

2 Click **Settings > Print Settings > Quality Menu > Toner Darkness**.

3 Adjust the toner darkness setting.

4 Click **Submit**.

Using the printer settings on the computer

Depending on your operating system, adjust the toner darkness settings using the Local Printer Settings Utility or Printer Settings.

Using the printer control panel

1 From the printer control panel, navigate to:

 > **Settings** >  > **Print Settings** >  > **Quality Menu** >  > **Toner Darkness** > 

2 Adjust the toner darkness.

3 Press .

Printing information pages

For more information on printing information pages, see “Printing a menu settings page” on page 28 and “Printing a network setup page” on page 29.

Printing a font sample list

From the printer control panel, navigate to either of the following:



 > **Reports** >  > **Print Fonts** >  > **PCL Fonts** > 

or

 > **Reports** >  > **Print Fonts** >  > **PostScript Fonts** > 

Canceling a print job

Canceling a print job from the printer control panel

From the printer control panel, press  > .

Canceling a print job from the computer

For Windows users

- 1 Open the printers folder.
 - a Click , or click **Start** and then click **Run**.
 - b In the Start Search or Run dialog, type **control printers**.
 - c Press **Enter**, or click **OK**.
- 2 Double-click the printer icon.
- 3 Select the print job you want to cancel.
- 4 Click **Delete**.

For Macintosh users

- 1 From the Apple Menu, navigate to either of the following:
 - **System Preferences > Print & Scan > select a printer > Open Print Queue**
 - **System Preferences > Print & Fax > select a printer > Open Print Queue**
- 2 From the printer window, select the print job you want to cancel, and then click **Delete**.

Understanding the printer menus

Menus list

Paper Menu

- Default Source
- Paper Size/Type
- Configure MP
- Substitute Size
- Paper Texture
- Paper Weight
- Paper Loading
- Custom Types
- Universal Setup

Reports

- Menu Settings Page
- Device Statistics
- Network Setup Page¹
- Profiles List
- Print Fonts
- Print Directory
- Asset Report

Network/Ports³

- Active NIC
- Standard Network²
- Reports
- Network card
- TCP/IP
- IPv6
- Wireless
- AppleTalk
- Standard USB
- SMTP Setup

Security

- Security Audit Log
- Set Date and Time

Settings

- General Settings
- Print Settings

¹ Depending on the printer setup, this menu item appears as Network Setup Page or Network [x] Setup Page.

² Depending on the printer setup, this menu item appears as Standard Network or Network [x].

³ The menu items in this menu appear only in network printers or printers connected to print servers.

Paper menu

Default Source menu

Use	To
Default Source Tray [x] MP Feeder Manual Paper Manual Envelope	Set a default paper source for all print jobs. Notes: <ul style="list-style-type: none"> • Tray 1 (standard tray) is the factory default setting. • From the Paper menu, set Configure MP to "Cassette" for MP Feeder to appear as a menu setting. • If two trays contain paper of the same size and type, and the trays have the same settings, then the trays are automatically linked. When one tray is empty, the print job continues using the linked tray.

Paper Size/Type menu

Use	To
<p>Tray [x] Size</p> <ul style="list-style-type: none"> A4 A5 A6 JIS-B5 Letter Legal Executive Oficio (Mexico) Folio Statement Universal 	<p>Specify the paper size loaded in each tray.</p> <p>Notes:</p> <ul style="list-style-type: none"> • Letter is the U.S. factory default setting. A4 is the international factory default setting. • If two trays contain paper of the same size and type, and the trays have the same settings, then the trays are automatically linked. When one tray is empty, the print job continues using the linked tray. • The A6 paper size is supported only in Tray 1 and the multipurpose feeder.
<p>Tray [x] Type</p> <ul style="list-style-type: none"> Plain Paper Transparency Recycled Labels Bond Letterhead Preprinted Colored Paper Light Paper Heavy Paper Rough/Cotton Custom Type [x] 	<p>Specify the type of paper loaded in each tray.</p> <p>Notes:</p> <ul style="list-style-type: none"> • Plain Paper is the factory default setting for Tray 1. Custom Type [x] is the factory default setting for all other trays. • If available, a user-defined name will appear instead of Custom Type [x]. • Use this menu to configure automatic tray linking.
<p>Note: Only installed trays and feeders are listed in this menu.</p>	

Use	To
<p>MP Feeder Size</p> <ul style="list-style-type: none"> A4 A5 A6 JIS B5 Letter Legal Executive Oficio (Mexico) Folio Statement Universal 7 3/4 Envelope 9 Envelope 10 Envelope DL Envelope C5 Envelope B5 Envelope Other Envelope 	<p>Specify the paper size loaded in the multipurpose feeder.</p> <p>Notes:</p> <ul style="list-style-type: none"> • Letter is the U.S. factory default setting. A4 is the international factory default setting. • From the Paper menu, set Configure MP to “Cassette” for MP Feeder Size to appear as a menu. • The multipurpose feeder does not automatically detect paper size. Make sure to set the paper size value.
<p>MP Feeder Type</p> <ul style="list-style-type: none"> Plain Paper Card Stock Transparency Recycled Labels Bond Envelope Rough Envelope Letterhead Preprinted Colored Paper Light Paper Heavy Paper Rough/Cotton Custom Type [x] 	<p>Specify the type of paper loaded in the multipurpose feeder.</p> <p>Notes:</p> <ul style="list-style-type: none"> • Custom Type [x] is the factory default setting. • From the Paper menu, set Configure MP to “Cassette” for MP Feeder Type to appear as a menu.
<p>Note: Only installed trays and feeders are listed in this menu.</p>	

Use	To
<p>Manual Paper Size</p> <ul style="list-style-type: none"> A4 A5 A6 JIS B5 Letter Legal Executive Oficio (Mexico) Folio Statement Universal 	<p>Specify the paper size being manually loaded.</p> <p>Note: Letter is the U.S. factory default setting. A4 is the international factory default setting.</p>
<p>Manual Paper Type</p> <ul style="list-style-type: none"> Plain Paper Card Stock Transparency Recycled Labels Bond Letterhead Preprinted Colored Paper Light Paper Heavy Paper Rough/Cotton Custom Type [x] 	<p>Specify the paper type being manually loaded.</p> <p>Notes:</p> <ul style="list-style-type: none"> • Plain Paper is the factory default setting. • From the Paper menu, set Configure MP to “Manual” for Manual Paper Type to appear as a menu.
<p>Manual Envelope Size</p> <ul style="list-style-type: none"> 7 3/4 Envelope 9 Envelope 10 Envelope DL Envelope C5 Envelope B5 Envelope Other Envelope 	<p>Specify the envelope size being manually loaded.</p> <p>Note: 10 Envelope is the U.S. factory default setting. DL Envelope is the international factory default setting.</p>
<p>Manual Envelope Type</p> <ul style="list-style-type: none"> Envelope Rough Envelope Custom Type [x] 	<p>Specify the envelope type being manually loaded.</p> <p>Note: Envelope is the factory default setting.</p>
<p>Note: Only installed trays and feeders are listed in this menu.</p>	

Configure MP menu

Use	To
Configure MP Cassette Manual First	Determine when the printer selects paper from the multipurpose feeder. Notes: <ul style="list-style-type: none"> • Cassette is the factory default setting. Cassette configures the multipurpose feeder as the default paper source. • Manual sets the multipurpose feeder only for manual-feed print jobs. • First sets the multipurpose feeder as the primary paper source regardless of settings.

Substitute Size menu

Use	To
Substitute Size Off Statement/A5 Letter/A4 All Listed	Substitute a specified paper size if the requested paper size is not available. Notes: <ul style="list-style-type: none"> • All Listed is the factory default setting. All available substitutions are allowed. • Off indicates that no size substitutions are allowed. • Setting a size substitution lets the print job continue without Change Paper appearing.

Paper Texture menu

Use	To
Plain Texture Smooth Normal Rough	Specify the relative texture of the plain paper loaded. Note: Normal is the factory default setting.
Card Stock Texture Smooth Normal Rough	Specify the relative texture of the card stock loaded. Notes: <ul style="list-style-type: none"> • Normal is the factory default setting. • The options appear only if card stock is supported.
Transparency Texture Smooth Normal Rough	Specify the relative texture of the transparencies loaded. Note: Normal is the factory default setting.
Recycled Texture Smooth Normal Rough	Specify the relative texture of the recycled paper loaded. Note: Normal is the factory default setting.

Use	To
Labels Texture Smooth Normal Rough	Specify the relative texture of the labels loaded. Note: Normal is the factory default setting.
Bond Texture Smooth Normal Rough	Specify the relative texture of the bond paper loaded. Note: Rough is the factory default setting.
Envelope Texture Smooth Normal Rough	Specify the relative texture of the envelopes loaded. Note: Normal is the factory default setting.
Rough Envelope Texture Rough	Specify the relative texture of the rough envelopes loaded.
Letterhead Texture Smooth Normal Rough	Specify the relative texture of the letterhead loaded. Note: Normal is the factory default setting.
Preprinted Texture Smooth Normal Rough	Specify the relative texture of the preprinted paper loaded. Note: Normal is the factory default setting.
Colored Texture Smooth Normal Rough	Specify the relative texture of the colored paper loaded. Note: Normal is the factory default setting.
Light Texture Smooth Normal Rough	Specify the relative texture of the paper loaded. Note: Normal is the factory default setting.
Heavy Texture Smooth Normal Rough	Specify the relative texture of the paper loaded. Note: Normal is the factory default setting.
Rough/Cotton Texture Rough	Specify the relative texture of the cotton paper loaded.
Custom [x] Texture Smooth Normal Rough	Specify the relative texture of the custom paper loaded. Notes: <ul style="list-style-type: none"> • Normal is the factory default setting. • The options appear only if the custom type is supported.

Paper Weight menu

Use	To
Plain Weight Light Normal Heavy	Specify the relative weight of the plain paper loaded. Note: Normal is the factory default setting.
Card Stock Weight Light Normal Heavy	Specify the relative weight of the card stock loaded. Note: Normal is the factory default setting.
Transparency Weight Light Normal Heavy	Specify the relative weight of the transparencies loaded. Note: Normal is the factory default setting.
Recycled Weight Light Normal Heavy	Specify the relative weight of the recycled paper loaded. Note: Normal is the factory default setting.
Labels Weight Light Normal Heavy	Specify the relative weight of the labels loaded. Note: Normal is the factory default setting.
Bond Weight Light Normal Heavy	Specify the relative weight of the bond paper loaded. Note: Normal is the factory default setting.
Envelope Weight Light Normal Heavy	Specify the relative weight of the envelope loaded. Note: Normal is the factory default setting.
Rough Envelope Weight Light Normal Heavy	Specify the relative weight of the rough envelope loaded. Note: Normal is the factory default setting.
Letterhead Weight Light Normal Heavy	Specify the relative weight of the letterhead loaded. Note: Normal is the factory default setting.
Preprinted Weight Light Normal Heavy	Specify the relative weight of the preprinted paper loaded. Note: Normal is the factory default setting.

Use	To
Colored Weight Light Normal Heavy	Specify the relative weight of the colored paper loaded. Note: Normal is the factory default setting.
Light Weight Light	Specify that the weight of the paper loaded is light.
Heavy Weight Heavy	Specify that the weight of the paper loaded is heavy.
Cotton/Rough Weight Light Normal Heavy	Specify the relative weight of the cotton or rough paper loaded. Note: Heavy is the factory default setting.
Custom [x] Weight Light Normal Heavy	Specify the relative weight of the custom paper loaded. Notes: <ul style="list-style-type: none"> • Normal is the factory default setting. • The options appear only when the custom type is supported.

Paper Loading menu

Use	To
Recycled Loading Duplex Off	Determine and set two-sided printing for all print jobs that specify Recycled as the paper type.
Bond Loading Duplex Off	Determine and set two-sided printing for all print jobs that specify Bond as the paper type.
Letterhead Loading Duplex Off	Determine and set two-sided printing for all print jobs that specify Letterhead as the paper type.
Preprinted Loading Duplex Off	Determine and set two-sided printing for all print jobs that specify Preprinted as the paper type.
Colored Loading Duplex Off	Determine and set two-sided printing for all print jobs that specify Colored as the paper type.
Notes: <ul style="list-style-type: none"> • Duplex sets two-sided printing as the default for all print jobs unless one-sided printing is set from Printing Preferences or Print dialog. • If Duplex is selected, then all print jobs are sent through the duplex unit, including one-sided jobs. • Off is the factory default setting for all the menus. 	

Use	To
Light Loading Duplex Off	Determine and set two-sided printing for all print jobs that specify Light as the paper type.
Heavy Loading Duplex Off	Determine and set two-sided printing for all print jobs that specify Heavy as the paper type.
Custom [x] Loading Duplex Off	Determine and set two-sided printing for all print jobs that specify Custom [x] as the paper type. Note: Custom [x] Loading is available only if the custom type is supported.
Notes: <ul style="list-style-type: none"> • Duplex sets two-sided printing as the default for all print jobs unless one-sided printing is set from Printing Preferences or Print dialog. • If Duplex is selected, then all print jobs are sent through the duplex unit, including one-sided jobs. • Off is the factory default setting for all the menus. 	

Custom Types menu

Use	To
Custom Type [x] Paper Card Stock Transparency Rough/Cotton Labels Envelope	Associate a paper or specialty media type with a Custom Type [x] name or a user-defined custom name created in the Embedded Web Server, in the Local Printer Settings Utility, or in MarkVision™ Professional. Notes: <ul style="list-style-type: none"> • Paper is the factory default setting for Custom Type [x]. • The specialty media type must be supported in the selected tray or feeder in order to print from that source.
Recycled Paper Card Stock Transparency Rough/Cotton Labels Envelope Cotton	Specify a paper type when the Recycled setting is selected in other menus. Notes: <ul style="list-style-type: none"> • Paper is the factory default setting. • The Recycled paper type must be supported in the selected tray or feeder in order to print from that source.

Universal Setup menu

Use	To
Units of Measure Inches Millimeters	Identify the units of measure. Notes: <ul style="list-style-type: none"> • Inches is the US factory default setting. • Millimeters is the international factory default setting.
Portrait Width 3–8.5 inches 76–216 mm	Set the portrait width. Notes: <ul style="list-style-type: none"> • If the width exceeds the maximum, then the printer uses the maximum width allowed. • 8.5 inches is the US factory default setting. You can increase the width in 0.01-inch increments. • 216 mm is the international factory default setting. You can increase the width in 1-mm increments.
Portrait Height 3–14.17 inches 76–360 mm	Set the portrait height. Notes: <ul style="list-style-type: none"> • If the height exceeds the maximum, then the printer uses the maximum height allowed. • 14 inches is the US factory default setting. You can increase the height in 0.01-inch increments. • 356 mm is the international factory default setting. You can increase the height in 1-mm increments.
Feed Direction Short Edge Long Edge	Specify the feed direction if the paper can be loaded in either direction. Notes: <ul style="list-style-type: none"> • Short Edge is the factory default setting. • Long Edge appears only when the longest edge is shorter than the maximum width supported in the tray.

Reports menu

Reports menu

Use	To
Menu Settings Page	Print a report containing information about the paper loaded in trays, installed memory, total page count, alarms, timeouts, printer control panel language, TCP/IP address, status of supplies, status of the network connection, and other information.
Device Statistics	Print a report containing printer statistics, such as supply information and details about printed pages.

Use	To
Network Setup Page	Print a report containing information about the network printer settings, such as the TCP/IP address information. Note: This menu item appears only in network printers or in printers connected to print servers.
Profiles List	Print a list of profiles stored in the printer. Note: This menu item appears only when LDSS is enabled.
Print Fonts PCL Fonts PostScript Fonts	Print a report of all the fonts available for the printer language currently set in the printer. Note: A separate list is available for PCL and PostScript emulations.
Print Directory	Print a list of all the resources stored in an optional flash memory card. Notes: <ul style="list-style-type: none"> • Job Buffer Size must be set to 100%. • Make sure the optional flash memory is installed correctly and working properly. • This menu item appears only when an optional flash memory card is installed.
Asset Report	Print a report containing printer asset information, such as serial number and model name.

Network/Ports menu

The menus in this section only appear in network printers or printers connected to print servers.

Active NIC menu

Use	To
Active NIC Auto [list of available network cards]	Notes: <ul style="list-style-type: none"> • Auto is the factory default setting. • This menu item appears only when an optional network card is installed.

Standard Network or Network [x] menu

Note: Only active ports appear in this menu. All inactive ports are omitted.

Use	To
PCL SmartSwitch On Off	Set the printer to automatically switch to PCL emulation when a print job requires it, regardless of the default printer language. Notes: <ul style="list-style-type: none"> • On is the factory default setting. • If PCL SmartSwitch is disabled, then the printer does not examine incoming data and it uses the default printer language specified in the Setup menu.

Use	To
PS SmartSwitch On Off	Set the printer to automatically switch to PS emulation when a print job requires it, regardless of the default printer language. Notes: <ul style="list-style-type: none"> • On is the factory default setting. • If PS SmartSwitch is disabled, then the printer does not examine incoming data and it uses the default printer language specified in the Setup menu.
NPA Mode Off Auto	Set the printer to perform the special processing required for bidirectional communication following the conventions defined by the NPA protocol. Notes: <ul style="list-style-type: none"> • Auto is the factory default setting. • Changing this setting from the printer control panel and then exiting the menus causes the printer to restart. The menu selection is then updated.
Network Buffer Disabled Auto 3KB to [maximum size allowed]	Set the size of the network input buffer. Notes: <ul style="list-style-type: none"> • Auto is the factory default setting. • The value can be changed in 1-KB increments. • The maximum size allowed depends on the amount of memory in the printer, the size of the other link buffers, and whether Resource Save is set to On or Off. • To increase the maximum size range for the Network Buffer, disable or reduce the size of the parallel, serial, and USB buffers. • Changing this setting from the printer control panel and then exiting the menus causes the printer to restart. The menu selection is then updated.
Mac Binary PS On Off Auto	Set the printer to process Macintosh binary PostScript print jobs. Notes: <ul style="list-style-type: none"> • Auto is the factory default setting. • Off filters print jobs using the standard protocol. • On processes raw binary PostScript print jobs.

Reports menu

To access the menu, navigate to either of the following:

- **Network/Ports > Standard Network > Standard Network Setup > Reports**
- **Network/Ports > Network [x] > Network [x] Setup > Reports**

Use	To
Print Setup Page	Print a report containing information about the network printer settings, such as the TCP/IP address.

Network Card menu

To access the menu, navigate to either of the following:

- **Network/Ports > Standard Network > Standard Network Setup > Network Card**
- **Network/Ports > Network [x] > Network [x] Setup > Network Card**

Use	To
View Card Status Connected Disconnected	View the connection status of the network card.
View Card Speed	View the speed of an active network card.
Network Address UAA LAA	View the network addresses.
Job Timeout 0–255 seconds	Set the amount of time it takes for a network print job to be canceled. Notes: <ul style="list-style-type: none"> • 90 seconds is the factory default setting. • A setting value of 0 disables the timeout. • If a value of 1–9 is selected, then the setting is saved as 10.

TCP/IP menu

To access the menu, navigate to any of the following:

- **Network/Ports > Standard Network > Standard Network Setup > TCP/IP**
- **Network/Ports > Network [x] > Network [x] Setup > TCP/IP**

Note: This menu is available only in network printers or printers connected to print servers.

Use	To
Set Hostname	Set the host name. Notes: <ul style="list-style-type: none"> • This setting can be changed only from the Embedded Web Server. • The host name can be up to 15 characters and can be a US-ASCII or alphanumeric character, or hyphen.
IP Address	View or change the current TCP/IP address. Note: Manually setting the IP address sets the “Enable DHCP” and “Enable Auto IP” settings to Off. It also sets “Enable BOOTP” and “Enable RARP” to Off on systems that support BOOTP and RARP.
Netmask	View or change the current TCP/IP netmask.
Gateway	View or change the current TCP/IP gateway.
Enable DHCP On Off	Specify the DHCP address and parameter assignment. Note: On is the factory default setting.

Use	To
Enable AutoIP Yes No	Specify the Zero Configuration Networking setting. Note: Yes is the factory default setting.
Enable FTP/TFTP Yes No	Enable the built-in FTP server, which lets you send files to the printer using File Transfer Protocol. Note: Yes is the factory default setting.
Enable HTTP Server Yes No	Enable the built-in Web server (Embedded Web Server). When enabled, the printer can be monitored and managed remotely using a Web browser. Note: Yes is the factory default setting.
WINS Server Address	View or change the current WINS server address.
Enable DDNS Yes No	View or change the current DDNS setting. Note: Yes is the factory default setting.
Enable mDNS Yes No	View or change the current mDNS setting. Note: Yes is the factory default setting.
DNS Server Address	View or change the current DNS server address.
Backup DNS Server Address	View or change the backup DNS server addresses.
Backup DNS Server Address 2	
Backup DNS Server Address 3	
Enable HTTPS Yes No	View or change the current HTTPS setting. Note: Yes is the factory default setting.

IPv6 menu

To access the menu, navigate to any of the following:

- **Network/Ports > Standard Network > Standard Network Setup > IPv6**
- **Network/Ports > Network [x] > Network [x] Setup > IPv6**

Note: This menu is available only in network printers or printers connected to print servers.

Use	To
Enable IPv6 On Off	Enable Internet Protocol Version Six (IPv6) in the printer. IPv6 uses bigger numbers to create IP addresses. Note: On is the factory default setting.
Auto Configuration On Off	Specify whether or not the network adapter accepts the automatic IPv6 address configuration entries provided by a router. Note: On is the factory default setting.
* These settings can be changed only from the Embedded Web Server.	

Use	To
Set Hostname*	Set the host name. Note: The host name is limited to 15 characters, and accepts US-ASCII, alphanumeric characters and hyphen only.
View Address*	View the current IPv6 addresses.
View Router Address*	View the current router address.
Enable DHCPv6 On Off	Enable DHCPv6 in the printer. Note: On is the factory default setting.
* These settings can be changed only from the Embedded Web Server.	

Wireless menu

Note: This menu is available only in printers connected to a wireless network or printer models that have a wireless network adapter.

To access the menu, navigate to any of the following:

- **Network/Ports > Network [x] > Network [x] Setup > Wireless**

Use	To
Network Mode Infrastructure Ad hoc	Specify the network mode. Notes: <ul style="list-style-type: none"> • Ad hoc is the factory default setting. This configures wireless connection directly between the printer and a computer. • Infrastructure lets the printer access a network using an access point.
Compatibility 802.11b/g 802.11b/g/n	Specify the wireless standard for the wireless network. Note: The 802.11b/g/n is the factory default setting.
Choose Network	Select an available network for the printer to use.
View Signal Quality	View the quality of the wireless connection.
View Security Mode	View the encryption method for the wireless network.

AppleTalk menu

Note: This menu is available only in printer models connected to a wired network or when an optional network card is installed.

To access the menu, navigate to any of the following:

- **Network/Ports > Standard Network > Standard Network Setup > AppleTalk**
- **Network/Ports > Network Setup [x] > AppleTalk**

Use	To
Activate Yes No	Enable or disable AppleTalk support. Note: Yes is the factory default setting.
View Name	Show the assigned AppleTalk name. Note: The name can be changed only from the Embedded Web Server.
View Address	Show the assigned AppleTalk address. Note: The address can be changed only from the Embedded Web Server.
Set Zone [list of zones available on the network]	Provide a list of AppleTalk zones available on the network. Note: The factory default setting is the default zone for the network. If no default zone exists, then the zone marked with an asterisk (*) is the default setting.

Standard USB menu

Use	To
PCL SmartSwitch On Off	Set the printer to automatically switch to PCL emulation when a print job received through a USB port requires it, regardless of the default printer language. Notes: <ul style="list-style-type: none"> • On is the factory default setting. • When set to Off, the printer does not examine incoming data. The printer uses PostScript emulation if the PS SmartSwitch is set to On. It uses the default printer language specified in the Setup menu if the PS SmartSwitch is set to Off.
PS SmartSwitch On Off	Set the printer to automatically switch to PS emulation when a print job received through a USB port requires it, regardless of the default printer language. Notes: <ul style="list-style-type: none"> • On is the factory default setting. • When set to Off, the printer does not examine incoming data. The printer uses PCL emulation if the PCL SmartSwitch is set to On. It uses the default printer language specified in the Setup menu if the PCL SmartSwitch is set to Off.
NPA Mode On Off Auto	Set the printer to perform the special processing required for bidirectional communication following the conventions defined by the NPA protocol. Notes: <ul style="list-style-type: none"> • Auto is the factory default setting. Auto sets the printer to examine data, determine the format, and then process it appropriately. • The printer automatically restarts when changing the setting from the printer control panel. The menu selection is then updated.

Use	To
USB Buffer Disabled Auto 3K to [maximum size allowed]	Set the size of the USB input buffer. Notes: <ul style="list-style-type: none"> • Auto is the factory default setting. • Disabled turns off job buffering. • The USB buffer size value can be changed in 1-KB increments. • The maximum size allowed depends on the amount of memory in the printer, the size of the other link buffers, and whether Resource Save is set to On or Off. • To increase the maximum size range for USB Buffer, disable or reduce the size of the parallel, serial, and network buffers. • The printer automatically restarts when the setting is changed from the printer control panel. The menu selection is then updated.
Mac Binary PS On Off Auto	Set the printer to process Macintosh binary PostScript print jobs. Notes: <ul style="list-style-type: none"> • Auto is the factory default setting. • On processes raw binary PostScript print jobs. • Off filters print jobs using the standard protocol.
ENA Address YYY.YYY.YYY.YYY	Set the network address information for an external print server. Note: This menu is available only when the printer is attached to an external print server through the USB port.
ENA Netmask YYY.YYY.YYY.YYY	Set the netmask information for an external print server. Note: This menu is available only when the printer is attached to an external print server through the USB port.
ENA Gateway YYY.YYY.YYY.YYY	Set the gateway information for an external print server. Note: This menu is available only when the printer is attached to an external print server through the USB port.

SMTP Setup menu

Use	To
Primary SMTP Gateway	Specify SMTP server gateway and port information. Note: 25 is the default SMTP gateway port.
Primary SMTP Gateway Port	
Secondary SMTP Gateway	
Secondary SMTP Gateway Port	
SMTP Timeout 5–30	Specify the amount of time in seconds before the server stops trying to send an e-mail. Note: 30 seconds is the factory default setting.
Reply Address	Specify a reply address of up to 128 characters in the e-mail sent by the printer.

Use	To
Use SSL Disabled Negotiate Required	Set the printer to use SSL for increased security when connecting to the SMTP server. Notes: <ul style="list-style-type: none"> • Disabled is the factory default setting. • When the Negotiate setting is used, the SMTP server determines if SSL will be used.
SMTP Server Authentication No authentication required Login/Plain CRAM-MD5 Digest-MD5 NTLM Kerberos 5	Specify the type of user authentication required for printing privileges. Note: “No authentication required” is the factory default setting.
Device-Initiated E-mail None Use Device SMTP Credentials	Specify what credentials will be used when communicating to the SMTP server. Some SMTP servers require credentials to send an e-mail. Notes: <ul style="list-style-type: none"> • None is the factory default setting for Device-Initiated E-mail. • Device Userid and Device Password are used to log in to the SMTP server when Use Device SMTP Credentials is selected.
Device Userid	
Device Password	

Security menu

Security Audit Log menu

Use	To
Export Log	Let an authorized user export the audit log. Notes: <ul style="list-style-type: none"> • To export the audit log from the printer control panel, connect a flash drive to the printer. • You can also download the audit log from the Embedded Web Server, and then save it on your computer.
Delete Log Delete now Do not delete	Specify whether or not audit logs are deleted. Note: Delete now is the factory default setting.

Use	To
Configure Log Enable Audit Yes No Enable Remote Syslog No Yes Remote Syslog Facility 0–23 Severity of events to log 0–7	Specify how and whether or not audit logs are created. Notes: <ul style="list-style-type: none"> • Enable Audit determines if events are recorded in the secure audit log and remote syslog. No is the factory default setting. • Enable Remote Syslog determines if logs are sent to a remote server. No is the factory default setting. • Remote Syslog Facility determines the value used to send logs to the remote syslog server. 4 is the factory default setting. • If the security audit log is activated, then the severity value of each event is recorded. 4 is the factory default setting.

Set Date and Time menu

Use	To
Current Date and Time	View the current date and time settings for the printer. Note: The date and time are set in YYYY-MM-DD HH:MM format.
Manually Set Date and Time [input date/time]	Enter the date and time. Note: Setting the date and time using this menu automatically sets Enable NTP to Off.
Time Zone [list of time zones]	Select the time zone. Note: GMT is the factory default setting.
Automatically observe DST On Off	Set the printer to use the applicable daylight saving time (DST) start and end times associated with the printer Time Zone setting. Note: On is the factory default setting.
Enable NTP On Off	Enable Network Time Protocol, which synchronizes the clocks of devices on a network. Notes: <ul style="list-style-type: none"> • On is the factory default setting. • Enable NTP is automatically set to Off if you manually set the date and time.

Settings menu

General Settings menu

Use	To
<p>Display Language</p> <ul style="list-style-type: none"> English Francais Deutsch Italiano Espanol Dansk Norsk Nederlands Svenska Portuguese Suomi Russian Polski Greek Magyar Turkce Cesky Simplified Chinese Traditional Chinese Korean Japanese 	<p>Set the language of the text appearing on the printer display.</p> <p>Note: Not all languages are available for all printers, and you may need to install special hardware for those languages to appear.</p>
<p>Show Supply Estimates</p> <ul style="list-style-type: none"> Show estimates Do not show estimates 	<p>View the estimates of the supplies on the printer control panel, Embedded Web Server, menu settings, and the device statistics reports.</p>
<p>Eco-Mode</p> <ul style="list-style-type: none"> Off Energy Energy/Paper Paper 	<p>Minimize the use of energy, paper, or specialty media.</p> <p>Notes:</p> <ul style="list-style-type: none"> • Off is the factory default setting. Off resets the printer to its factory default settings. • Energy minimizes the power used by the printer. • Energy/Paper minimizes the use of power and of paper and specialty media. • Paper minimizes the amount of paper and specialty media needed for a print job.

Use	To
Run Initial setup Yes No	Run the setup wizard. Notes: <ul style="list-style-type: none"> • Yes is the factory default setting. • After completing the setup wizard by selecting Done at the country or region selection screen, the default becomes No.
Paper Sizes US Metric	Specify the unit of measurement for paper sizes. Notes: <ul style="list-style-type: none"> • US is the factory default setting. • The initial setting is determined by your country or region selection in the initial setup wizard.
Timeouts Sleep Mode Disabled 1–120 min	Set the amount of time the printer waits after a job is printed before it goes into a reduced power state. Notes: <ul style="list-style-type: none"> • “30 min” is the factory default setting. • “Disabled” appears only when Energy Conserve is set to Off. • Lower settings conserve more energy, but may require longer warm-up times. • Select a high setting if the printer is in constant use. Under most circumstances, this keeps the printer ready to print with minimum warm-up time.
Timeouts Hibernate Timeout Disabled 1 hour 2 hours 3 hours 6 hours 1 day 2 days 3 days 1 week 2 weeks 1 month	Set the amount of time the printer waits before it enters Hibernate mode. Notes: <ul style="list-style-type: none"> • “Disabled” is the factory default setting in all countries except European Union countries and Switzerland. • “3 days” is the factory default setting for all European Union countries and Switzerland.
Timeouts Hibernate Timeout on Connection Hibernate Do Not Hibernate	Set the printer to Hibernate mode even if there is an active Ethernet connection. Note: “Do Not Hibernate” is the factory default setting.
Timeouts Screen Timeout 15–300 sec	Set the amount of time in seconds the printer waits before the it returns to a ready state. Note: “30 sec” is the factory default setting.

Use	To
Timeouts Prolong Screen Timeout On Off	Display a message that lets you reset the screen timeout timer instead of returning to the printer display. Note: Off is the factory default setting.
Timeouts Print Timeout Disabled 1–255 sec	Set the amount of time in seconds the printer waits to receive an end-of-job message before canceling the remainder of the print job. Notes: <ul style="list-style-type: none"> • “90 sec” is the factory default setting. • When the timer expires, any partially printed page still in the printer is printed, and then the printer checks to see if any new print jobs are waiting. • Print Timeout is available only when using PCL emulation. This setting has no effect on PostScript emulation print jobs.
Timeouts Wait Timeout Disabled 15–65535 sec	Set the amount of time in seconds the printer waits for additional data before canceling a print job. Note: “40 sec” is the factory default setting.
Print Recovery Auto Continue Disabled 5–255 sec	Let the printer automatically continue printing from certain offline situations when these are not resolved within the specified time period. Note: Disabled is the factory default setting.
Print Recovery Jam Recovery On Off Auto	Specify whether the printer reprints jammed pages. Notes: <ul style="list-style-type: none"> • Auto is the factory default setting. The printer reprints jammed pages unless the memory required to hold the pages is needed for other printer tasks. • On sets the printer to always reprint jammed pages. • Off sets the printer to never reprint jammed pages.
Print Recovery Jam Assist On Off	Notes: <ul style="list-style-type: none"> • On is the factory default setting. On sets the printer to automatically dump blank pages or partially printed pages to the standard bin after a jammed page has been cleared. • Off requires the user to remove all pages from all possible jam locations.
Print Recovery Page Protect Off On	Successfully print a page that may not have printed otherwise. Notes: <ul style="list-style-type: none"> • Off is the factory default setting. Off prints a partial page when there is not enough memory to print the whole page. • On sets the printer to process the whole page so that the entire page prints.

Use	To
Press Sleep Button Do nothing Sleep Hibernate	Determine how the printer, while in idle state, reacts to a short press of the Sleep button. Note: Sleep is the factory default setting.
Press and Hold Sleep Button Do nothing Sleep Hibernate	Determine how the printer, while in idle state, reacts to a long press of the Sleep button. Note: Sleep is the factory default setting.
Factory Defaults Do Not Restore Restore Now	Use the printer factory default settings. Notes: <ul style="list-style-type: none"> • Do Not Restore is the factory default setting. Do Not Restore retains the user-defined settings. • Restore Now sets all printer settings to the factory default settings except Network/Ports menu settings. All downloads stored in the RAM are deleted. Downloads stored in the flash memory are not affected.
Custom Home Message Off IP Address Hostname Contact Name Location Zero Configuration Name Custom Text 1	Select a custom home message that appears as an alternating display of the printer status. Note: Off is the factory default setting.

Print Settings

Setup menu

Use	To
Printer Language PCL Emulation PS Emulation	Set the default printer language. Notes: <ul style="list-style-type: none"> • PCL Emulation is the factory default setting. • PostScript emulation uses a PostScript interpreter for processing print jobs. • PCL Emulation uses a PCL interpreter for processing print jobs. • Setting a printer language default does not prevent a software program from sending print jobs that use another printer language.

Use	To
<p>Print Area</p> <p>Normal</p> <p>Whole Page</p>	<p>Set the logical and physical printable area.</p> <p>Notes:</p> <ul style="list-style-type: none"> • Normal is the factory default setting. When attempting to print data on the non-printable area defined by the Normal setting, the printer clips the image at the boundary. • Whole Page allows the image to be moved into the non-printable area defined by the Normal setting. This setting affects only pages printed using a PCL 5 interpreter and has no effect on pages printed using the PCL XL or PostScript interpreter.
<p>Download Target</p> <p>RAM</p> <p>Flash</p>	<p>Set the storage location for downloads.</p> <p>Notes:</p> <ul style="list-style-type: none"> • RAM is the factory default setting. Storing downloads in the RAM is temporary. • Storing downloads in a flash memory places them in permanent storage. Downloads remain in the flash memory even when the printer is turned off. • This menu item appears only when an optional flash memory is installed.
<p>Resource Save</p> <p>On</p> <p>Off</p>	<p>Specify how the printer handles temporary downloads, such as fonts and macros stored in the RAM, when the printer receives a print job that requires more than the available memory.</p> <p>Notes:</p> <ul style="list-style-type: none"> • Off is the factory default setting. Off sets the printer to retain downloads only until memory is needed. Downloads are deleted in order to process print jobs. • On sets the printer to retain downloads during language changes and printer resets. If the printer runs out of memory, then Memory Full [38] appears on the printer display, but downloads are not deleted.

Finishing menu

Use	To
Sides (Duplex) 1 sided 2 sided	Specify whether two-sided (duplex) printing is set as the default for all print jobs. Notes: <ul style="list-style-type: none"> • “1 sided” is the factory default setting. • You can set two-sided printing from the software program. For Windows users: <ol style="list-style-type: none"> 1 Click File > Print. 2 Click Properties, Preferences, Options, or Setup. For Macintosh users: <ol style="list-style-type: none"> 1 Choose File > Print. 2 Adjust the settings from the print dialog and pop-up menus.
Duplex Binding Long Edge Short Edge	Define the way two-sided pages are bound and printed. Notes: <ul style="list-style-type: none"> • Long Edge is the factory default setting. Long Edge binds pages along their long edge (left edge for portrait and top edge for landscape). • Short Edge binds pages along their short edge (top edge for portrait and left edge for landscape).
Copies 1–999	Specify the default number of copies for each print job. Note: 1 is the factory default setting.
Blank Pages Do Not Print Print	Specify whether to insert blank pages in a print job. Note: Do Not Print is the factory default setting.
Collate (1,1,1) (2,2,2) (1,2,3) (1,2,3)	Stack the pages of a print job in sequence when printing multiple copies. Note: “(1,2,3) (1,2,3)” is the factory default setting.
Separator Sheets Off Between Copies Between Jobs Between Pages	Specify whether to insert blank separator sheets. Notes: <ul style="list-style-type: none"> • Off is the factory default setting. • Between Copies inserts a blank sheet between each copy of a print job if Collate is set to (1,1,1) (2,2,2). If Collate is set to (1,2,3) (1,2,3), then a blank page is inserted between each set of printed pages, such as after all page 2's and after all page 3's. • Between Jobs inserts a blank sheet between print jobs. • Between Pages inserts a blank sheet between each page of a print job. This setting is useful when printing transparencies or when inserting blank pages in a document.
Separator Source Tray [x] Multi-Purpose Feeder	Specify the paper source for separator sheets. Note: Tray 1 (standard tray) is the factory default setting.

Use	To
Paper Saver Off 2-Up 3-Up 4-Up 6-Up 9-Up 12-Up 16-Up	Print multiple-page images on one side of a paper. Notes: <ul style="list-style-type: none"> • Off is the factory default setting. • The number selected is the number of page images that will print per side.
Paper Saver Ordering Horizontal Reverse Horizontal Reverse Vertical Vertical	Specify the positioning of multiple-page images when using Paper Saver. Notes: <ul style="list-style-type: none"> • Horizontal is the factory default setting. • Positioning depends on the number of page images and whether they are in portrait or landscape orientation.
Paper Saver Orientation Auto Landscape Portrait	Specify the orientation of a multiple-page document. Note: Auto is the factory default setting. The printer chooses between portrait and landscape.
Paper Saver Border None Solid	Print a border when using Paper Saver. Note: None is the factory default setting.

Quality menu

Use	To
Print Resolution 300 dpi 600 dpi 1200 dpi 1200 Image Q 2400 Image Q	Specify the printed output resolution in dots per inch. Note: 600 dpi is the factory default setting.
Pixel Boost Off Fonts Horizontally Vertically Both directions Isolated	Enable more pixels to print in clusters for clarity, in order to enhance images horizontally or vertically, or to enhance fonts. Note: Off is the factory default setting.
Toner Darkness 1–10	Lighten or darken the printed output. Notes: <ul style="list-style-type: none"> • 8 is the factory default setting. • Selecting a smaller number can help conserve toner.

Use	To
Enhance Fine Lines On Off	Enable a print mode preferable for files such as architectural drawings, maps, electrical circuit diagrams, and flow charts. Notes: <ul style="list-style-type: none"> • Off is the factory default setting. • You can set this option from the printer software. For Windows users, click File > Print, and then click Properties, Preferences, Options, or Setup. For Macintosh users, choose File > Print, and then adjust the settings from the Print dialog and pop-up menus. • To set this option using the Embedded Web Server, type the network printer IP address in the Web browser address field.
Gray Correction Auto Off	Automatically adjust the contrast enhancement applied to images. Note: Auto is the factory default setting.
Brightness -6 to 6	Adjust the printed output either by lightening or darkening it. You can conserve toner by lightening the output. Note: 0 is the factory default setting.
Contrast 0–5	Adjust the contrast of printed objects. Note: 0 is the factory default setting.

Utilities menu

Use	To
Format Flash Yes No	Format the flash memory. Warning—Potential Damage: Do not turn off the printer while the flash memory is being formatted. Notes: <ul style="list-style-type: none"> • Flash memory refers to the memory added by installing a flash memory card in the printer. • Yes deletes all data stored in the flash memory. • No cancels the format request. • The flash memory option card must not be read/write- or write-protected. • This menu item appears only when a non-defective flash memory card is installed.
Hex Trace	Assist in isolating the source of a print job problem. Notes: <ul style="list-style-type: none"> • When activated, all data sent to the printer is printed in hexadecimal and character representation, and control codes are not executed. • To exit or deactivate Hex Trace, turn off or reset the printer.
Coverage Estimator Off On	Provide an estimate of the percentage coverage of toner on a page. The estimate is printed on a separate page at the end of each print job. Note: Off is the factory default setting.

XPS menu

Use	To
Print Error Pages Off On	Print a page containing information on errors, including XML markup errors. Note: Off is the factory default setting.

PostScript menu

Use	To
Print PS Error On Off	Print a page containing the PostScript error. Note: Off is the factory default setting.
Lock PS Startup Mode On Off	Disable the SysStart file. Note: Off is the factory default setting.
Font Priority Resident Flash	Establish the font search order. Notes: <ul style="list-style-type: none"> • Resident is the factory default setting. • This menu item is available only when a formatted flash memory card is installed and operating properly. • Make sure the flash memory card is not read/write-, write-, or password-protected. • Job Buffer Size must not be set to 100%.

PCL Emul menu

Use	To
Font Source Resident Download Flash All	Specify the set of fonts used by the Font Name menu. Notes: <ul style="list-style-type: none"> • “Resident” is the factory default setting. “Resident” shows the factory default set of fonts downloaded in the RAM. • “Download” shows all the fonts downloaded in the RAM. • “Flash” shows all fonts resident in that option. The optional flash memory card must be properly formatted and cannot be read/write-, write-, or password-protected. • “All” shows all fonts available to any option.
Font Name Courier 10	Identify a specific font and the option where it is stored. Note: Courier 10 is the factory default setting. Courier 10 shows the font name, font ID, and the storage location in the printer. The font source abbreviation is R for Resident, F for Flash, and D for Download.

Use	To
Symbol Set 10U PC-8 12U PC-850	Specify the symbol set for each font name. Notes: <ul style="list-style-type: none"> • 10U PC-8 is the US factory default setting. 12U PC-850 is the international factory default setting. • A symbol set is a set of alphabetic and numeric characters, punctuation, and special symbols. Symbol sets support the different languages or specific program, such as math symbols for scientific text. Only the supported symbol sets are shown.
PCL Emulation Settings Point Size 1.00–1008.00	Change the point size for scalable typographic fonts. Notes: <ul style="list-style-type: none"> • 12 is the factory default setting. • Point size refers to the height of the characters in the font. One point equals approximately 0.014 inch. • Point sizes can be increased or decreased in 0.25-point increments.
PCL Emulation Settings Pitch 0.08–100	Specify the font pitch for scalable monospaced fonts. Notes: <ul style="list-style-type: none"> • 10 is the factory default setting. • Pitch refers to the number of fixed-space characters per inch (cpi). • Pitch can be increased or decreased in 0.01-cpi increments. • For nonscalable monospaced fonts, the pitch appears on the display but it cannot be changed.
PCL Emulation Settings Orientation Portrait Landscape	Specify the orientation of text and graphics on the page. Notes: <ul style="list-style-type: none"> • Portrait is the factory default setting. Portrait prints text and graphics parallel to the short edge of the page. • Landscape prints text and graphics parallel to the long edge of the page.
PCL Emulation Settings Lines per Page 1–255	Specify the number of lines that print on each page. Notes: <ul style="list-style-type: none"> • 60 is the US factory default setting. 64 is the international default setting. • The printer sets the amount of space between each line based on the Lines per Page, Paper Size, and Orientation settings. Select the Paper Size and Orientation you want before setting Lines per Page.
PCL Emulation Settings A4 Width 198 mm 203 mm	Set the printer to print on A4-size paper. Notes: <ul style="list-style-type: none"> • 198 mm is the factory default setting. • The 203-mm setting sets the width of the page to allow printing of eighty 10-pitch characters.

Use	To
PCL Emulation Settings Auto CR after LF On Off	Specify whether the printer automatically performs a carriage return (CR) after a line feed (LF) control command. Note: Off is the factory default setting.
PCL Emulation Settings Auto LF after CR On Off	Specify whether the printer automatically performs a line feed (LF) after a carriage return (CR) control command. Note: Off is the factory default setting.
Tray Renumber Assign MP Feeder Off None 0–199 Assign Tray [x] Off None 0–199 Assign Manual Paper Off None 0–199 Assign Manual Env Off None 0–199	Configure the printer to work with printer software or programs that use different source assignments for trays and feeders. Notes: <ul style="list-style-type: none"> • Off is the factory default setting. • None cannot be selected. It is only displayed when it is selected by the PCL 5 interpreter. It also ignores the Select Paper Feed command. • 0–199 allows a custom setting to be assigned.
Tray Renumber View Factory Defaults MPF Default = 8 T1 Default = 1 T1 Default = 4 T1 Default = 5 T1 Default = 20 T1 Default = 21 Env Default = 6 MPaper Default = 2 MEnv Default = 3	Display the factory default setting assigned to each tray or feeder.
Tray Renumber Restore Defaults Yes No	Restore all tray and feeder assignments to their factory default settings.

Saving money and the environment

Lexmark is committed to environmental sustainability and is continually improving its printers to reduce their impact on the environment. We design with the environment in mind, engineer our packaging to reduce materials, and provide collection and recycling programs. For more information, see:

- The Notices chapter
- The Environmental Sustainability section of the Lexmark Web site at www.lexmark.com/environment
- The Lexmark recycling program at www.lexmark.com/recycle

By selecting certain printer settings or tasks, you may be able to reduce your printer's impact even further. This chapter outlines the settings and tasks that may yield a greater environmental benefit.

Saving paper and toner

Studies show that as much as 80% of the carbon footprint of a printer is related to paper usage. You can significantly reduce your carbon footprint by using recycled paper and the following printing suggestions, such as printing on both sides of the paper and printing multiple pages on one side of a single sheet of paper.

For information on how you can quickly save paper and energy using one printer setting, see “Using Eco-Mode” on page 84.

Using recycled paper

As an environmentally conscious company, Lexmark supports the use of recycled office paper produced specifically for use in laser printers. For more information on recycled papers that work well with your printer, see “Using recycled paper and other office papers” on page 44.

Conserving supplies

Use both sides of the paper

If your printer model supports duplex printing, then you can control whether print appears on one or two sides of the paper by selecting **2-sided printing** from the Print dialog or from the Lexmark Toolbar.

Place multiple pages on one sheet of paper

You can print up to 16 consecutive pages of a multiple-page document onto one side of a single sheet of paper by selecting a setting from the Multipage printing (N-Up) section of the Print dialog screen.

Check your first draft for accuracy

Before printing or making multiple copies of a document:

- Use the preview feature, which you can select from the Print dialog or from the Lexmark Toolbar to see how the document will look like before you print it.
- Print one copy of the document to check its content and format for accuracy.

Avoid paper jams

Correctly set the paper type and size to avoid paper jams. For more information, see “Avoiding jams” on page 103.

Saving energy

Using Eco-Mode

Use Eco-Mode to quickly select one or more ways to reduce your printer's environmental impact.

1 From the printer control panel, navigate to:

 > **Settings** >  > **General Settings** >  > **Eco-Mode** >  > select the setting you want

Use	To
Off	Use the factory default settings for all settings associated with Eco-Mode. This setting supports the performance specifications for your printer.
Energy	Reduce energy use, especially when the printer is idle. <ul style="list-style-type: none"> • Printer engine motors do not start until a document is ready to print. You may notice a short delay before the first page is printed. • The printer enters Sleep mode after one minute of inactivity.
Energy/Paper	Use all the settings associated with Energy and Paper modes.
Paper	<ul style="list-style-type: none"> • Enable the automatic two-sided (duplex) printing feature. • Turn off print log features.

2 Press .

Using Hibernate mode

Hibernate is an ultra-low-power operating mode. When operating in Hibernate mode, all other systems and devices are powered down safely.

Note: Hibernate mode can be scheduled. For more information, see “Using Schedule Power Modes” on page 86.

Using the Embedded Web Server

1 Open a Web browser, and then type the printer IP address in the address field.

Notes:

- View the printer IP address in the TCP/IP section in the Network/Ports menu. The IP address appears as four sets of numbers separated by periods, such as 123.123.123.123.
- If your are using a proxy server, then temporarily disable it to load the Web page correctly.

2 Click **Settings > General Settings > Sleep Button Settings**.

- 3 From the Press Sleep Button or Press and Hold Sleep Button drop-down menu, select **Hibernate**.
- 4 Click **Submit**.

Note: If the printer is in Hibernate mode, the Embedded Web Server is disabled.

Using the printer control panel

- 1 From the printer control panel, navigate to:

 > **Settings** >  > **General Settings** > 

- 2 Press **Press Sleep Button** or **Press and Hold Sleep Button**, and then press .

- 3 Press **Hibernate** > .

Notes:

- When Press Sleep Button is set to Hibernate, a short press of the Sleep button sets the printer to Hibernate mode.
- When Press and Hold Sleep Button is set to Hibernate, a long press of the Sleep button sets the printer to Hibernate mode.

Adjusting Sleep mode

To save energy, decrease the number of minutes before the printer enters Sleep mode.

Available settings range from 1 to 120 minutes. The factory default setting is 30 minutes.

Note: Sleep mode can be scheduled. For more information, see “Using Schedule Power Modes” on page 86.

Using the Embedded Web Server

- 1 From the Embedded Web Server, click **Settings** > **General Settings** > **Timeouts**.
- 2 In the Sleep Mode field, enter the number of minutes you want the printer to wait before it enters Sleep mode.
- 3 Click **Submit**.

Using the printer control panel

- 1 From the printer control panel, navigate to:

 > **Settings** >  > **General Settings** >  > **Timeouts** >  > **Sleep Mode** > 

- 2 In the Sleep Mode field, select the number of minutes you want the printer to wait before it enters Sleep mode.

- 3 Press .

Setting Hibernate Timeout

Hibernate Timeout lets you set the amount of time the printer waits after a print job is processed before it goes into a reduced power state.

Using the Embedded Web Server

- 1 Open a Web browser, and then type the printer IP address in the address field.

Notes:

- Print a network setup page or menu settings page, and then locate the IP address in the TCP/IP section. The IP address appears as four sets of numbers separated by periods, such as 123.123.123.123.
- If you are using a proxy server, then temporarily disable it to load the Web page correctly.

- 2 Click **Settings > General Settings > Timeouts**.

- 3 From the Hibernate Timeout menu, select the number of hours, days, weeks, or months you want for the printer to wait before it goes into a reduced power state.

- 4 Click **Submit**.

Using the printer settings on the computer

Depending on your operating system, access the Hibernate Timeout menu using the Local Printer Settings Utility or Print Settings.

Using Schedule Power Modes

Schedule Power Modes lets the user schedule when the printer goes into a reduced power state or into the Ready state.

Using the Embedded Web Server

- 1 Open a Web browser, and then type the printer IP address in the address field.

Notes:

- Print a network setup page or menu settings page, and then locate the IP address in the TCP/IP section. The IP address appears as four sets of numbers separated by periods, such as 123.123.123.123.
- If you are using a proxy server, then temporarily disable it to load the Web page correctly.

- 2 Click **Settings > General Settings > Schedule Power Modes**.

- 3 From the Action menu, select the power mode.

- 4 From the Time menu, select the time.

- 5 From the Day(s) menu, select the day or days.

- 6 Click **Add**.

Using the printer settings on the computer (Windows only)

- Access the Schedule Power Modes menu using the Local Printer Settings Utility.

Recycling

Lexmark provides collection programs and environmentally progressive approaches to recycling. For more information, see:

- The Notices chapter
- The Environmental Sustainability section of the Lexmark Web site at www.lexmark.com/environment
- The Lexmark recycling program at www.lexmark.com/recycle

Recycling Lexmark products

To return Lexmark products for recycling:

- 1 Go to www.lexmark.com/recycle.
- 2 Find the product type you want to recycle, and then select your country or region from the list.
- 3 Follow the instructions on the computer screen.

Note: Printer supplies and hardware not listed in the Lexmark collection program may be recycled through your local recycling center. Contact your local recycling center to determine the items they accept.

Recycling Lexmark packaging

Lexmark continually strives to minimize packaging. Less packaging helps to ensure that Lexmark printers are transported in the most efficient and environmentally sensitive manner and that there is less packaging to dispose of. These efficiencies result in fewer greenhouse emissions, energy savings, and natural resource savings.

Lexmark cartons are 100% recyclable where corrugated recycling facilities exist. Facilities may not exist in your area.

The foam used in Lexmark packaging is recyclable where foam recycling facilities exist. Facilities may not exist in your area.

When you return a cartridge to Lexmark, you can reuse the box that the cartridge came in. Lexmark will recycle the box.

Returning Lexmark cartridges for reuse or recycling

Lexmark Cartridge Collection Program diverts millions of Lexmark cartridges from landfills annually by making it both easy and free for Lexmark customers to return used cartridges to Lexmark for reuse or recycling. One hundred percent of the empty cartridges returned to Lexmark are either reused or demanufactured for recycling. Boxes used to return the cartridges are also recycled.

To return Lexmark cartridges for reuse or recycling, follow the instructions that came with your printer or cartridge and use the prepaid shipping label. You can also do the following:

- 1 Go to www.lexmark.com/recycle.
- 2 From the Toner Cartridges section, select your country or region.
- 3 Follow the instructions on the computer screen.

Securing the printer

Using the security lock feature

The printer is equipped with a security lock feature. Attach a security lock compatible with most laptop computers in the location shown to secure the printer in place.



Statement of Volatility

Your printer contains various types of memory that can store device and network settings, and user data.

Type of memory	Description
Volatile memory	Your printer uses standard <i>random access memory</i> (RAM) to temporarily buffer user data during simple print jobs.
Non-volatile memory	Your printer may use two forms of non-volatile memory: EEPROM and NAND (flash memory). Both types are used to store operating system, device settings, and network information.



Erase the content of any installed printer memory in the following circumstances:

- The printer is being decommissioned.
- The printer is being moved to a different department or location.
- The printer is being serviced by someone from outside your organization.
- The printer is being removed from your premises for service.
- The printer is being sold to another organization.

Erasing volatile memory

The volatile memory (RAM) installed in your printer requires a power source to retain information. To erase the buffered data, simply turn off the printer.

Erasing non-volatile memory

- 1 Turn off the printer.
- 2 From the printer control panel, hold down  and the right arrow button while turning the printer on. Release the buttons only when the Configuration menu appears.
- 3 Press the arrow buttons until **Wipe All Settings** appears, and then press .

The printer will restart several times during this process.

Note: Wipe All Settings securely removes device settings, solutions, jobs, and passwords from the printer memory.

- 4 Press the arrow buttons until **Exit Config Menu** appears, and then press .

The printer will perform a power-on reset, and then return to normal operating mode.

Finding printer security information

In high-security environments, it may be necessary to take additional steps to make sure that confidential data stored in the printer cannot be accessed by unauthorized persons. For more information, visit the [Lexmark security Web page](#).

You can also see the *Embedded Web Server Administrator's Guide* for additional information:

- 1 Go to <http://support.lexmark.com>, and then click **SELECT YOUR PRODUCT**.
- 2 From the "Search by Product Category" section, navigate to **Software and Solutions > Other Applications**.
- 3 Click the **Manuals** tab, and then select the *Embedded Web Server Administrator's Guide*.

Maintaining the printer

Warning—Potential Damage: Failure to maintain optimum printer performance, or to replace parts and supplies, may cause damage to your printer.

Cleaning the printer

Cleaning the printer

Note: You may need to perform this task after every few months.

Warning—Potential Damage: Damage to the printer caused by improper handling is not covered by the printer warranty.

- 1 Make sure that the printer is turned off and unplugged from the electrical outlet.



CAUTION—SHOCK HAZARD: To avoid the risk of electrical shock when cleaning the exterior of the printer, unplug the power cord from the electrical outlet and disconnect all cables from the printer before proceeding.

- 2 Remove paper from the standard bin and multipurpose feeder.
- 3 Remove any dust, lint, and pieces of paper around the printer using a soft brush or vacuum.
- 4 Dampen a clean, lint-free cloth with water, and use it to wipe the outside of the printer.

Warning—Potential Damage: Do not use household cleaners or detergents to prevent damage to the exterior of the printer.

- 5 Make sure all areas of the printer are dry before sending a new print job.

Checking the status of parts and supplies

A message appears on the display when a replacement supply item is needed or when maintenance is required.

Checking the status of parts and supplies

Using the Embedded Web Server

- 1 Open a Web browser, and then type the printer IP address in the address field.

Notes:

- View the printer IP address in the TCP/IP section in the Network/Ports menu. The IP address appears as four sets of numbers separated by periods, such as 123.123.123.123.
- If you are using a proxy server, then temporarily disable it to load the Web page correctly.

- 2 Click **Device Status > More Details**.

Using the printer control panel

From the printer control panel, navigate to:



Note: You can view the status of parts and supplies in the “Supply Information” section of the pages printed.

Estimated number of remaining pages

The estimated number of remaining pages is based on the recent printing history of the printer. Its accuracy may vary significantly and is dependent on many factors, such as actual document content, print quality settings, and other printer settings.

The accuracy of the estimated number of remaining pages may decrease when the actual printing consumption is different from the historical printing consumption. Consider the variable level of accuracy before purchasing or replacing supplies based on the estimate. Until an adequate print history is obtained on the printer, initial estimates assume future supplies consumption based on the International Organization for Standardization* test methods and page content.

* Average continuous black declared cartridge yield in accordance with ISO/IEC 19752.

Ordering supplies

To order supplies in the U.S., contact Lexmark at 1-800-539-6275 for information about Lexmark authorized supplies dealers in your area. In other countries or regions, visit the Lexmark Web Site at www.lexmark.com or contact the place where you purchased the printer.

Note: All life estimates for printer supplies assume printing on letter- or A4-size plain paper.

Using genuine Lexmark parts and supplies

Your Lexmark printer is designed to function best with genuine Lexmark supplies and parts. Use of third-party supplies or parts may affect the performance, reliability, or life of the printer and its imaging components. Use of third-party supplies or parts can affect warranty coverage. Damage caused by the use of third-party supplies or parts is not covered by the warranty. All life indicators are designed to function with Lexmark supplies and parts, and may deliver unpredictable results if third-party supplies or parts are used. Imaging component usage beyond the intended life may damage your Lexmark printer or its associated components.

Ordering toner cartridges

Notes:

- The estimated cartridge yield is based on the ISO/IEC 19752 standard.
- Extremely low print coverage for extended periods of time may negatively affect actual yield.

Item	Return Program cartridge
For the United States and Canada	
Toner Cartridge	501
High Yield Toner Cartridge	501H
Extra High Yield Toner Cartridge	501X ¹
Ultra High Yield Toner Cartridge	501U ²
For the European Union, European Economic Area , and Switzerland	
Toner Cartridge	502
High Yield Toner Cartridge	502H
Extra High Yield Toner Cartridge	502X ¹
Ultra High Yield Toner Cartridge	502U ²
For the Asia Pacific Region (includes Australia and New Zealand)	
Toner Cartridge	503
High Yield Toner Cartridge	503H
Extra High Yield Toner Cartridge	503X ¹
Ultra High Yield Toner Cartridge	503U ²
For Latin America (includes Puerto Rico and Mexico)	
Toner Cartridge	504
High Yield Toner Cartridge	504H
Extra High Yield Toner Cartridge	504X ¹
Ultra High Yield Toner Cartridge	504U ²
For Africa, Middle East, Central Eastern Europe, and Commonwealth of Independent States	
Toner Cartridge	505
High Yield Toner Cartridge	505H
Extra High Yield Toner Cartridge	505X ¹
Ultra High Yield Toner Cartridge	505U ²
<p>¹ This cartridge is supported only in MS410d, MS410dn, MS510dn, MS610dn, and MS610de printer models.</p> <p>² This cartridge is supported only in MS510dn, MS610dn, and MS610de printer models.</p> <p>For more information on countries located in each region, visit www.lexmark.com/regions.</p>	

Item	Regular cartridge
Worldwide	
High Yield Toner Cartridge	500HA ¹
<p>¹ This cartridge is supported only in MS310d and MS310dn printer models.</p> <p>² This cartridge is supported only in MS410d and MS410dn printer models.</p> <p>³ This cartridge is supported only in MS510dn, MS610dn, and MS610de printer models.</p>	

Item	Regular cartridge
Extra High Yield Toner Cartridge	500XA ²
Ultra High Yield Toner Cartridge	500UA ³
¹ This cartridge is supported only in MS310d and MS310dn printer models. ² This cartridge is supported only in MS410d and MS410dn printer models. ³ This cartridge is supported only in MS510dn, MS610dn, and MS610de printer models.	

Ordering an imaging unit

Extremely low print coverage for extended periods of time may cause imaging unit parts to fail prior to exhaustion of toner from toner cartridge.

For more information on replacing the imaging unit, see the instruction sheet that came with the supply.

Part name	Lexmark Return Program	Regular
Imaging unit	500Z	500ZA

Storing supplies

Choose a cool, clean storage area for the printer supplies. Store supplies right side up in their original packing until you are ready to use them.

Do not expose supplies to:

- Direct sunlight
- Temperatures above 35°C (95°F)
- High humidity above 80%
- Salty air
- Corrosive gases
- Heavy dust

Replacing supplies

Replacing the toner cartridge

- 1 Press the button on the right side of the printer, and then open the front door.

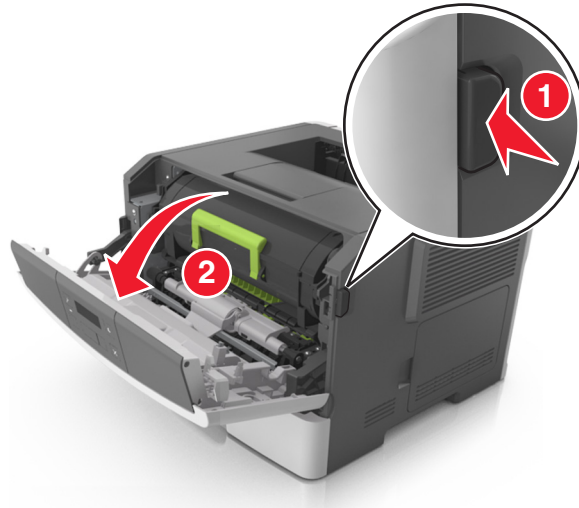

- 2 Pull the toner cartridge out using the handle.

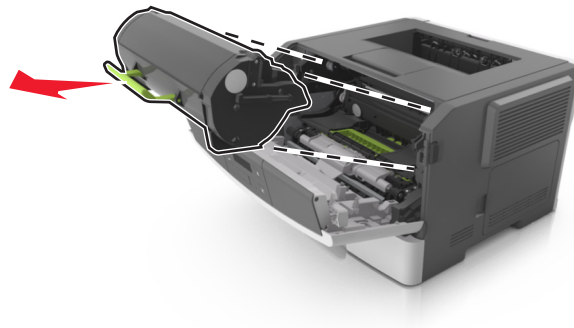

- 3 Unpack the toner cartridge, and then remove all packing materials.
- 4 Shake the new cartridge to redistribute the toner.

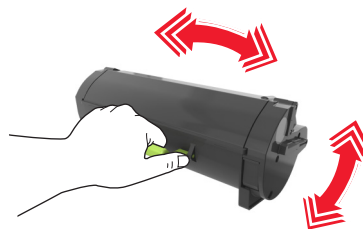

- 5 Insert the toner cartridge into the printer by aligning the side rails of the cartridge with the arrows on the side rails inside the printer.

Warning—Potential Damage: Do not expose the imaging unit to direct light for more than 10 minutes. Extended exposure to light may cause print quality problems.

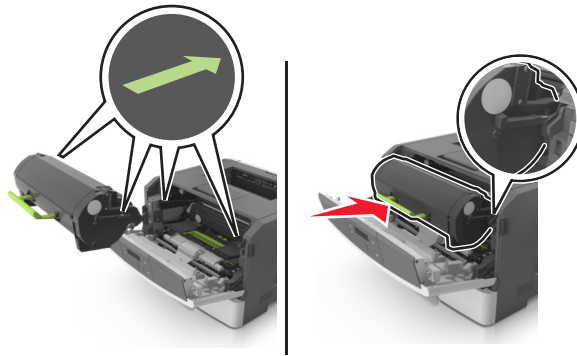

6 Close the front door.

Replacing the imaging unit

1 Press the button on the right side of the printer, and then open the front door.

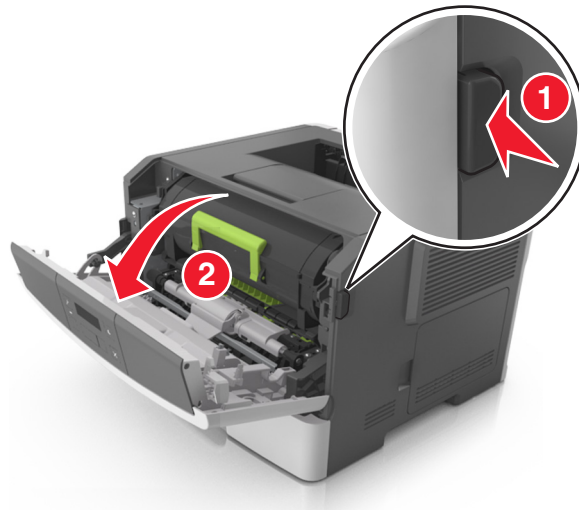

2 Pull the toner cartridge out using the handle.

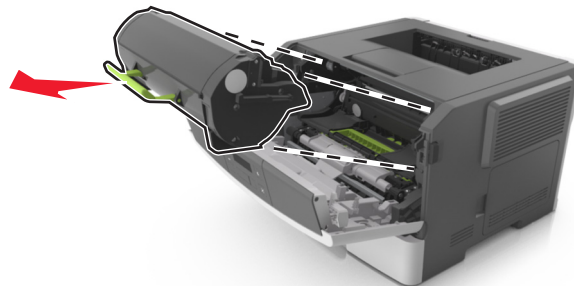

- 3 Lift the green handle, and then pull the imaging unit out of the printer.

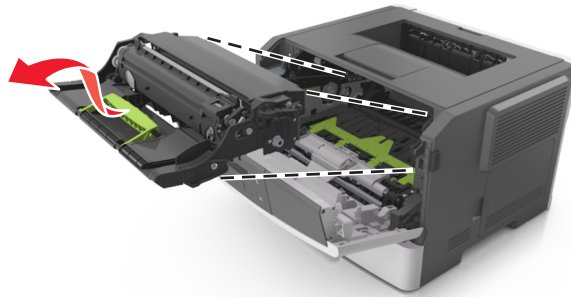

- 4 Unpack the new imaging unit, and then shake it.

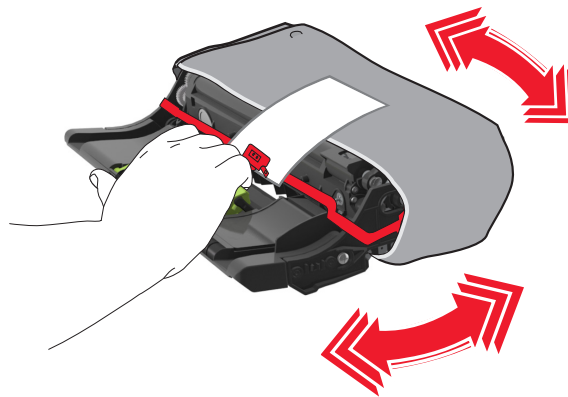

- 5 Remove all packing materials from the imaging unit.

Warning—Potential Damage: Do not expose the imaging unit to direct light for more than 10 minutes. Extended exposure to light may cause print quality problems.

Warning—Potential Damage: Do not touch the photoconductor drum. Doing so may affect the print quality of future print jobs.

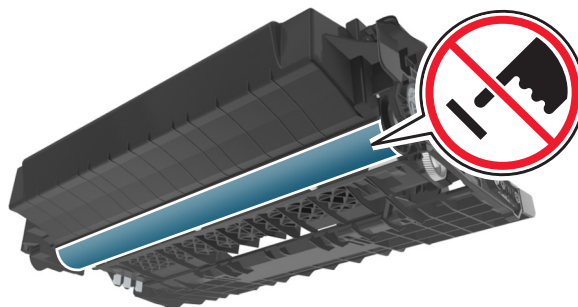

- 6 Insert the imaging unit into the printer by aligning the arrows on the side rails of the imaging unit with the arrows on the side rails inside the printer.

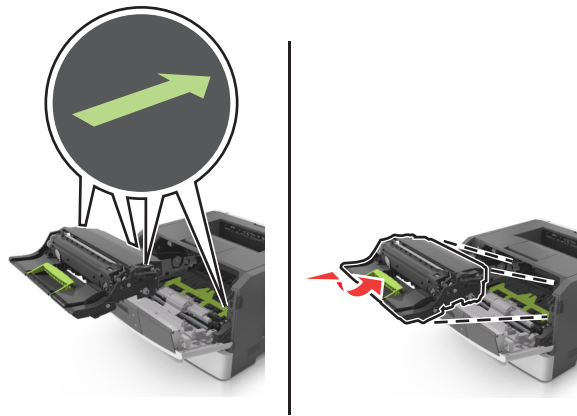

- 7 Insert the toner cartridge into the printer by aligning the side rails of the cartridge with the arrows on the side rails inside the printer.

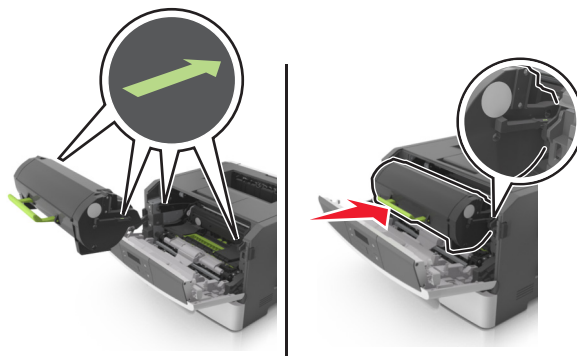

- 8 Close the front door.

Moving the printer

Before moving the printer

⚠ CAUTION—POTENTIAL INJURY: Before moving the printer, follow these guidelines to avoid personal injury or printer damage:

- Turn the printer off using the power switch, and then unplug the power cord from the electrical outlet.
- Disconnect all cords and cables from the printer before moving it.

- If an optional tray is installed, then remove it from the printer. To remove the optional tray, slide the latch on the right side of the tray toward the front of the tray until it *clicks* into place.



- Use the handholds located on both sides of the printer to lift it.
- Make sure your fingers are not under the printer when you set it down.
- Before setting up the printer, make sure there is adequate clearance around it.

Use only the power cord provided with this product or the manufacturer's authorized replacement.

Warning—Potential Damage: Damage to the printer caused by improper moving is not covered by the printer warranty.

Moving the printer to another location

The printer and its hardware options can be safely moved to another location by following these precautions:

- Any cart used to move the printer must have a surface able to support the full footprint of the printer.
- Any cart used to move the hardware options must have a surface able to support the dimensions of the hardware options.
- Keep the printer in an upright position.
- Avoid severe jarring movements.

Shipping the printer

When shipping the printer, use the original packaging.

Managing the printer

Finding advanced networking and administrator information

This chapter covers basic administrative support tasks using the Embedded Web Server. For more advanced system support tasks, see the *Networking Guide* on the *Software and Documentation CD* or the *Embedded Web Server Administrator's Guide* on the Lexmark Web site at <http://support.lexmark.com>.

Checking the virtual display

- 1 Open a Web browser, and then type the printer IP address in the address field.

Notes:

- Print a network setup page or menu settings page, and then locate the IP address in the TCP/IP section. The IP address appears as four sets of numbers separated by periods, such as 123.123.123.123.
- If you are using a proxy server, then temporarily disable it to load the Web page correctly.

- 2 Press **Enter** to open the Web page of your printer.

- 3 Click **Applications > Remote Operator Panel > Launch VNC Applet**.

Note: VNC Applet requires a Java plug-in to launch.

- 4 Click **Click here to continue**.

The virtual display works as an actual display would work on a printer control panel.

Viewing reports

You can view some reports from the Embedded Web Server. These reports are useful for assessing the status of the printer, network, and supplies.

- 1 Open a Web browser, and then type the printer IP address in the address field.

Notes:

- View the printer IP address in the TCP/IP section in the Network/Ports menu. The IP address appears as four sets of numbers separated by periods, such as 123.123.123.123.
- If you are using a proxy server, then temporarily disable it to load the Web page correctly.

- 2 Click **Reports**, and then click the type of report you want to view.

Configuring supply notifications from the Embedded Web Server

You can determine how you would like to be notified when supplies run nearly low, low, very low, or reach their end-of-life by setting the selectable alerts.

Notes:

- Selectable alerts can be set on the toner cartridge and imaging unit.
- All selectable alerts can be set for nearly low, low, and very low supply conditions. Not all selectable alerts can be set for the end-of-life supply condition. E-mail selectable alert is available for all supply conditions.
- The percentage of estimated remaining supply that prompts the alert can be set on some supplies for some supply conditions.

1 Open a Web browser, and then type the printer IP address in the address field.

Notes:

- View the printer IP address in the TCP/IP section in the Network/Ports menu. The IP address appears as four sets of numbers separated by periods, such as 123.123.123.123.
- If you are using a proxy server, then temporarily disable it to load the Web page correctly.

2 Click **Settings > Print Settings > Supply Notifications**.

3 From the drop-down menu for each supply, select one of the following notification options:

Notification	Description
Off	The normal printer behavior for all supplies occurs.
E-mail Only	The printer generates an e-mail when the supply condition is reached. The status of the supply will appear on the menus page and status page.
Warning	The printer displays the warning message and generates an e-mail about the status of the supply. The printer does not stop when the supply condition is reached.
Continuable Stop ¹	The printer stops processing jobs when the supply condition is reached, and the user needs to press a button to continue printing.
Non Continuable Stop ^{1,2}	The printer stops when the supply condition is reached. The supply must be replaced to continue printing.
¹ The printer generates an e-mail about the status of the supply when supply notification is enabled.	
² The printer stops when some supplies become empty to prevent damage.	

4 Click **Submit**.

Modifying confidential print settings

Note: This feature is available only in network printers or printers connected to print servers.

1 Open a Web browser, and then type the printer IP address in the address field.

Notes:

- View the printer IP address in the TCP/IP section in the Network/Ports menu. The IP address appears as four sets of numbers separated by periods, such as 123.123.123.123.
- If you are using a proxy server, then temporarily disable it to load the Web page correctly.

2 Click **Configuration > Other Settings tab > Security > Confidential Print Setup**.

3 Modify the settings:

- Set a maximum number of PIN entry attempts. When a user exceeds a specific number of PIN entry attempts, all of the jobs for that user are deleted.
- Set an expiration time for confidential print jobs. When a user has not printed the jobs within the specified time, all of the jobs for that user are deleted.

4 Save the modified settings.

Copying printer settings to other printers

Note: This feature is available only in network printers.

1 Open a Web browser, and then type the printer IP address in the address field.

Notes:

- View the printer IP address in the TCP/IP section in the Network/Ports menu. The IP address appears as four sets of numbers separated by periods, such as 123.123.123.123.
- If you are using a proxy server, then temporarily disable it to load the Web page correctly.

2 Click the **Copy Printer Settings**.

3 To change the language, select a language from the drop-down menu, and then click **Click here to submit language**.

4 Click **Printer Settings**.

5 Type the IP addresses of the source and target printers in their appropriate fields.

Note: If you want to add or remove a target printer, then click **Add Target IP** or **Remove Target IP**.

6 Click **Copy Printer Settings**.

Restoring factory default settings

If you want to keep a list of the current menu settings for reference, then print a menu settings page before restoring the factory default settings. For more information, see “Printing a menu settings page” on page 28.

If you want a more comprehensive method of restoring the printer factory default settings, then perform the Wipe All Settings option. For more information, see “Erasing non-volatile memory” on page 89.

Warning—Potential Damage: Restoring factory defaults returns most printer settings to the original factory default settings. Exceptions include the display language, custom sizes and messages, and Network/Port menu settings. All downloads stored in the RAM are deleted.

From the printer control panel, navigate to:



Creating a printer control panel PIN

The Panel PIN Protect menu lets you restrict access to the menus from the printer control panel. To restrict access to the menus, create a Personal Identification Number (PIN), and then assign the PIN to each menu.

1 Open a Web browser, and then type the printer IP address in the address field.

Notes:

- View the printer IP address in the TCP/IP section in the Network/Ports menu. The IP address appears as four sets of numbers separated by periods, such as 123.123.123.123.
- If you are using a proxy server, then temporarily disable it to load the Web page correctly.

2 Click **Settings > Security > Panel PIN Protect**.

3 From the Create User PIN or Create Admin PIN sections, enter your PIN.

Note: You can enter up to 16 digits for your PIN.

4 Click **Modify**.

5 From any menu in the Administrative Menus, Management, or Function Access sections, select **User PIN Protected** or **Admin PIN Protected** or **Admin PIN and User PIN Protected**.

Note: Using an Admin PIN, you can still access a menu assigned with a User PIN.

6 Click **Submit**.

If you try to access a PIN-protected menu from the printer control panel, the printer will require you to enter the PIN.

Note: After you enter the last digit of the PIN, make sure to press  on the printer control panel for more than three seconds.

Clearing jams

Carefully select paper and specialty media and load them properly to avoid most jams. For more information, see “Avoiding jams” on page 103. If jams occur, then follow the steps outlined in this chapter.

Note: Jam recovery is set to Auto by default. The printer reprints jammed pages unless the memory required to hold the pages is needed for other printer tasks.

Avoiding jams

Load paper properly

- Make sure paper lies flat in the tray.

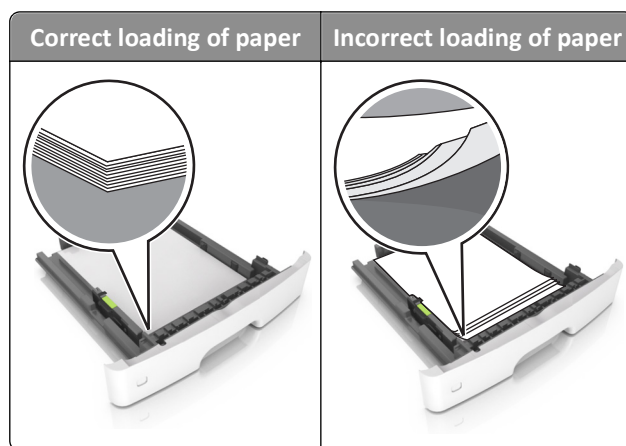

- Do not remove a tray while the printer is printing.
- Do not load a tray while the printer is printing. Load it before printing, or wait for a prompt to load it.
- Do not load too much paper. Make sure the stack height is below the maximum paper fill indicator.

- Do not slide the paper into the tray. Load paper as shown in the illustration.

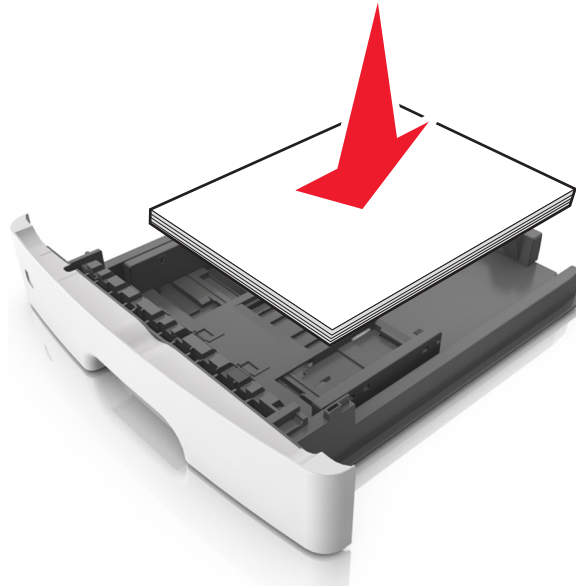

- Make sure the guides in the tray or the multipurpose feeder are properly positioned and are not pressing tightly against the paper or envelopes.
- Push the tray firmly into the printer after loading paper.

Use recommended paper

- Use only recommended paper or specialty media.
- Do not load wrinkled, creased, damp, bent, or curled paper.
- Flex, fan, and straighten paper before loading it.

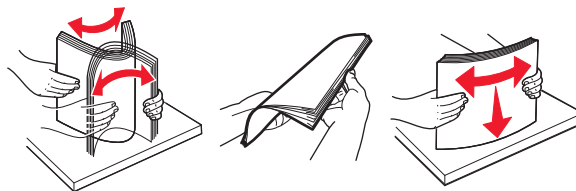

- Do not use paper that has been cut or trimmed by hand.
- Do not mix paper sizes, weights, or types in the same tray.
- Make sure the paper size and type are set correctly on the computer or printer control panel.
- Store paper according to manufacturer recommendations.

Understanding jam messages and locations

When a jam occurs, a message indicating the jam location and information to clear the jam appears on the printer display. Open the doors, covers, and trays indicated on the display to remove the jam.

Notes:

- When Jam Assist is set to On, the printer automatically flushes blank pages or pages with partial prints to the standard bin after a jammed page has been cleared. Check your printed output stack for discarded pages.

- When Jam Recovery is set to On or Auto, the printer reprints jammed pages. However, the Auto setting does not guarantee that the page will print.

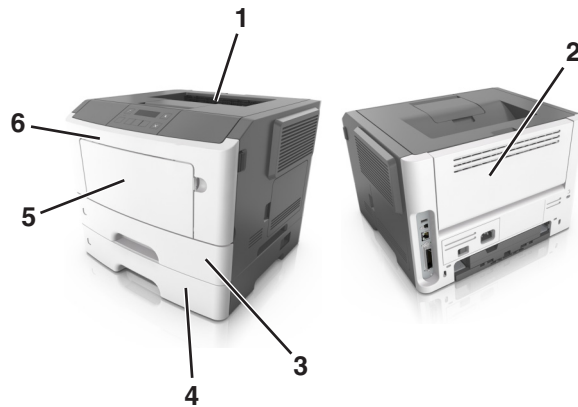

	Area	Printer control panel message	What to do
1	Standard bin	Jam, standard bin [20y.xx]	Remove the jammed paper.
2	Rear door	Jam, rear door [20y.xx]	Open the rear door, and then remove the jammed paper.
3	Tray 1	Jam, pull tray 1. Push down blue flap. [23y.xx]	Pull tray 1 completely out, then push the front duplex flap down, and then remove the jammed paper. Note: You may need to open the rear door to clear some 23y.xx paper jams.
4	Tray [x]	Jam, tray [x] [24y.xx]	Pull the indicated tray out, and then remove the jammed paper.
5	Multipurpose feeder	Jam, MP feeder. [250.xx]	Remove all paper from the multipurpose feeder, and then remove the jammed paper.
6	Front door	Jam, front door. [20y.xx]	Open the front door, and then remove the toner cartridge, imaging unit, and jammed paper.

Jam, front door [20y.xx]

 **CAUTION—HOT SURFACE:** The inside of the printer might be hot. To reduce the risk of injury from a hot component, allow the surface to cool before touching it.

- 1 Press the button on the right side of the printer, and then open the front door.

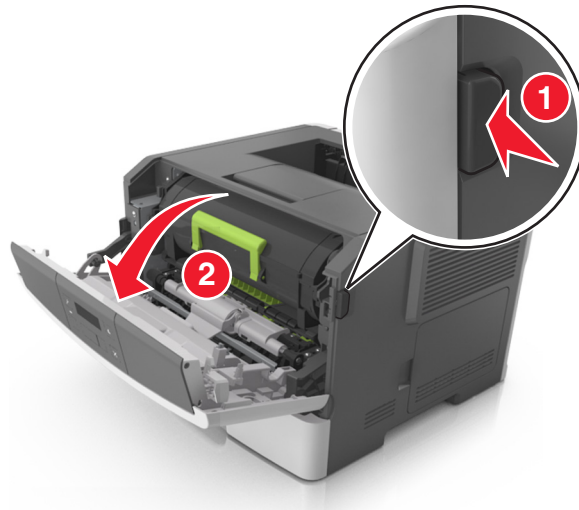

- 2 Pull the toner cartridge out using the handle.

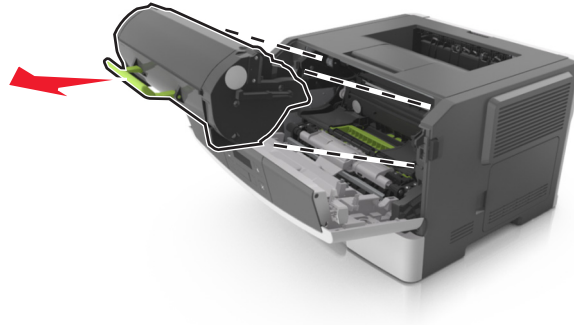

- 3 Lift the green handle, and then pull the imaging unit out of the printer.

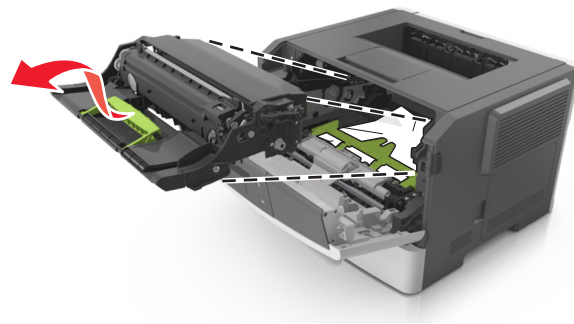

Warning—Potential Damage: Do not touch the photoconductor drum. Doing so may affect the print quality of future print jobs.

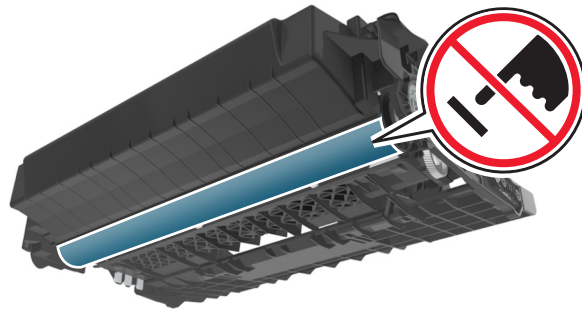

- 4 Place the imaging unit aside on a flat, smooth surface.

Warning—Potential Damage: Do not expose the imaging unit to direct light for more than 10 minutes. Extended exposure to light can cause print quality problems.

- 5 Lift the green flap in front of the printer.

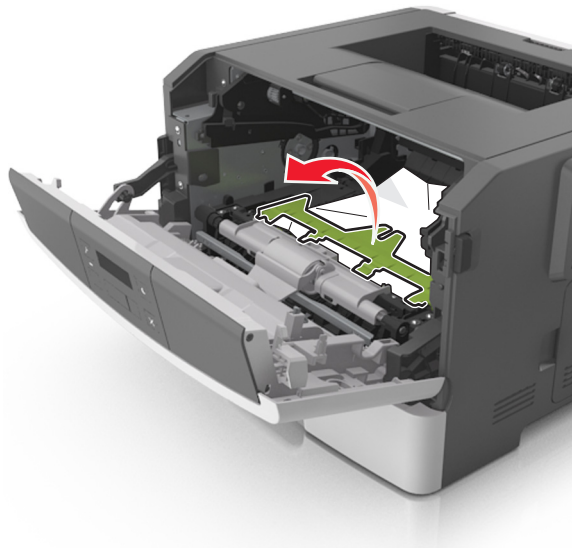

- 6 Firmly grasp the jammed paper on each side, and then gently pull it out.

Note: Make sure all paper fragments are removed.

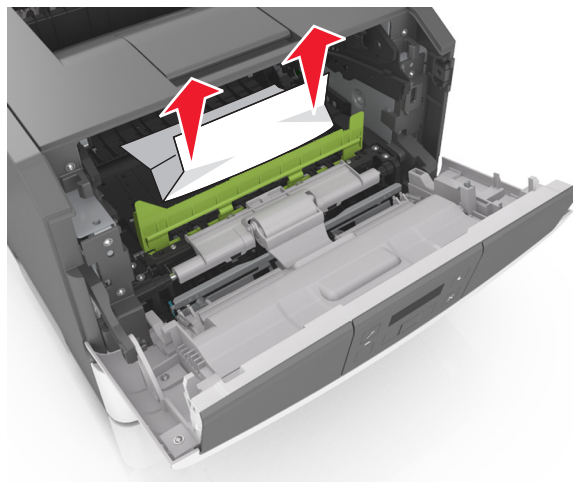

- 7** Insert the imaging unit by aligning the arrows on the side rails of the unit with the arrows on the side rails inside the printer, and then insert the imaging unit into the printer.

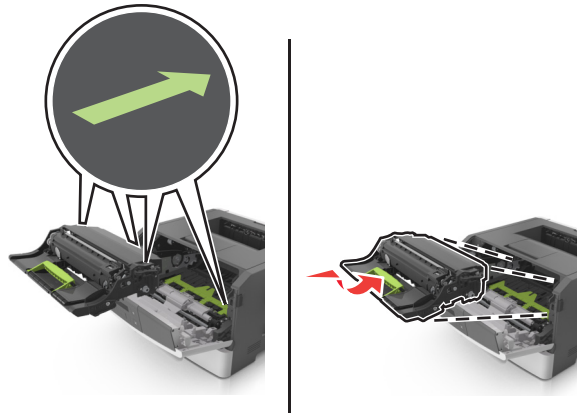

- 8** Insert the toner cartridge by aligning the side rails of the cartridge with the arrows on the side rails inside the printer, and then insert the cartridge into the printer.

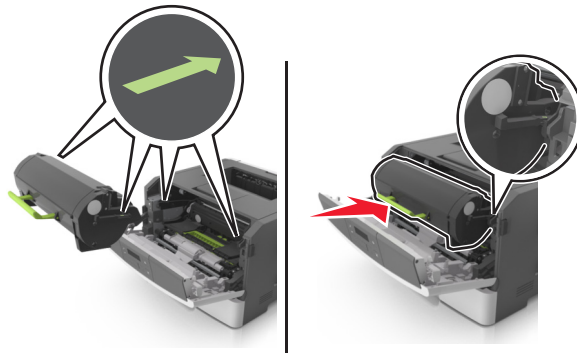

- 9** Close the front door.

- 10** From the printer control panel, press **OK** to clear the message and continue printing.

Jam, rear door [20y.xx]

- 1 Press the button on the right side of the printer, and then open the front door.

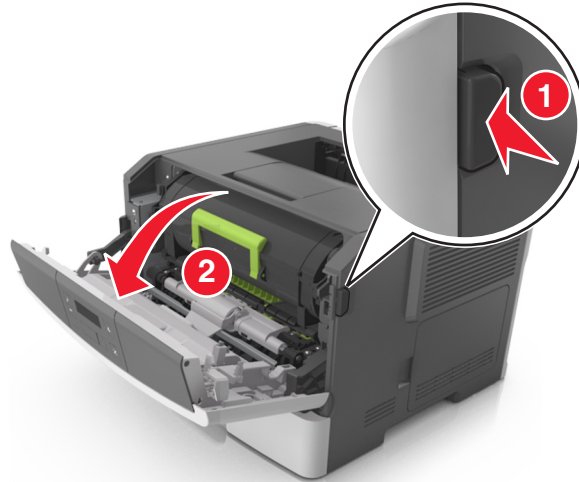

- 2 Gently pull down the rear door.



CAUTION—HOT SURFACE: The inside of the printer might be hot. To reduce the risk of injury from a hot component, allow the surface to cool before touching it.

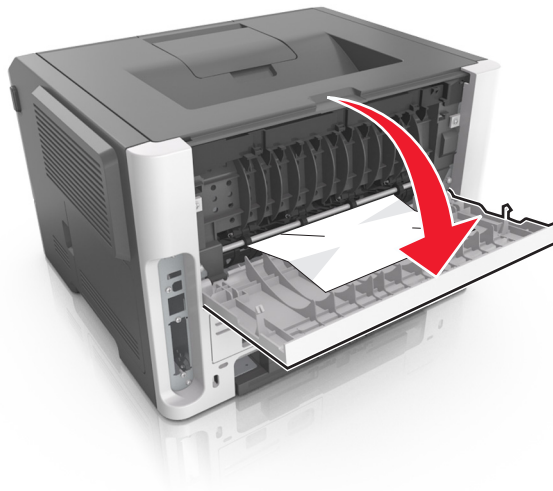

- 3 Firmly grasp the jammed paper on each side, and then gently pull it out.

Note: Make sure all paper fragments are removed.

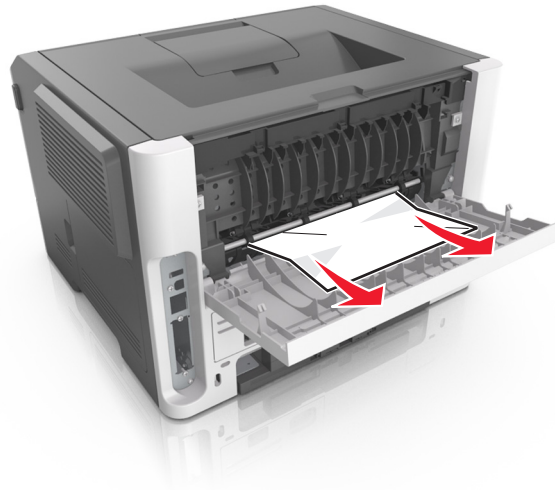

4 Close the rear and front doors.

5 From the printer control panel, press **OK** to clear the message and continue printing.

Jam, standard bin [20y.xx]

1 Firmly grasp the jammed paper on each side, and then gently pull it out.

Note: Make sure all paper fragments are removed.



2 From the printer control panel, press **OK** to clear the message and continue printing.

Jam, pull tray 1. Push down blue flap. [23y.xx]

 **CAUTION—HOT SURFACE:** The inside of the printer might be hot. To reduce the risk of injury from a hot component, allow the surface to cool before touching it.

- 1 Pull the tray out completely.

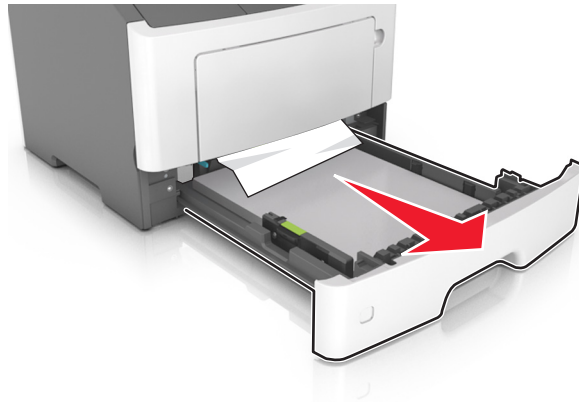

- 2 Locate the blue lever, and then pull it down to release the jam.

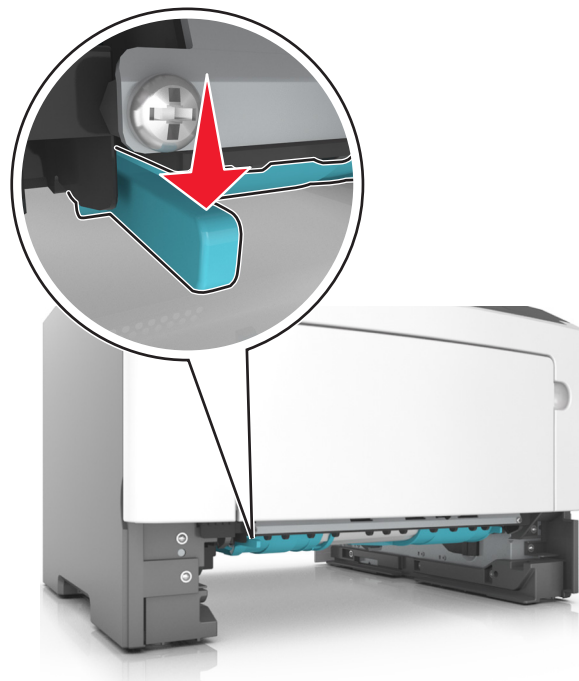

Note: If the jammed paper is not visible in the duplex area, then open the rear door, and then gently remove the jammed paper. Make sure all paper fragments are removed.

- 3 Firmly grasp the jammed paper on each side, and then gently pull it out.

Note: Make sure all paper fragments are removed.

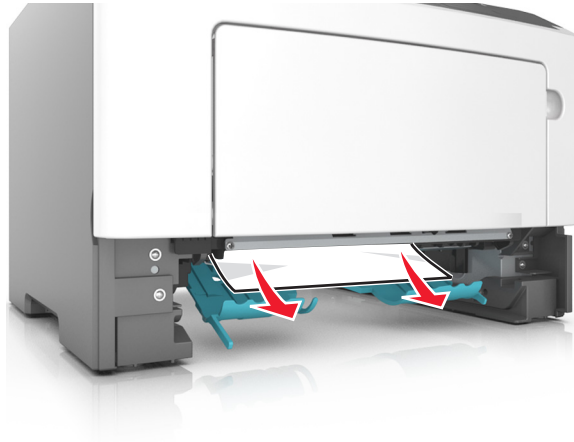

4 Insert the tray.

5 From the printer control panel, press **OK** to clear the message and continue printing.

Jam, tray [x] [24y.xx]

1 Pull out the tray completely.

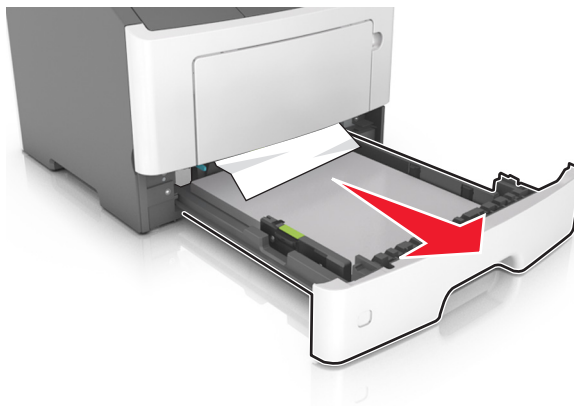

2 Firmly grasp the jammed paper on each side, and then gently pull it out.

Note: Make sure all paper fragments are removed.

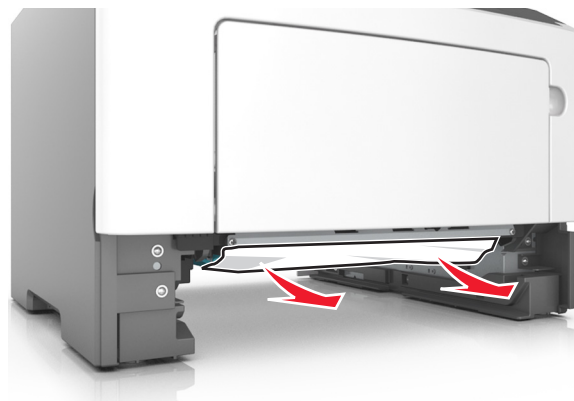

3 Insert the tray.

4 From the printer control panel, press **OK** to clear the message and continue printing.

Jam, MP feeder [250.xx]

1 From the multipurpose feeder, firmly grasp the jammed paper on each side, and then gently pull it out.

Note: Make sure all paper fragments are removed.

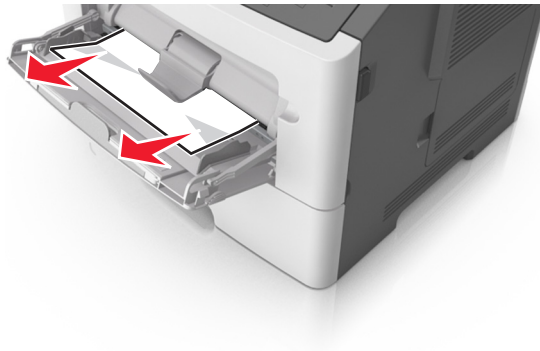

2 Flex the sheets of paper back and forth to loosen them, and then fan them. Do not fold or crease the paper. Straighten the edges on a level surface.

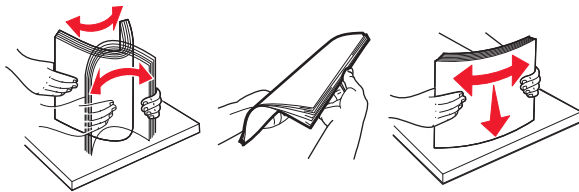

3 Reload paper into the multipurpose feeder.



Note: Make sure the paper guide lightly rests against the edge of the paper.

4 From the printer control panel, press **OK** to clear the message and continue printing.

Troubleshooting

Understanding the printer messages

Cartridge, imaging unit mismatch [41.xy]

- 1 Check if the toner cartridge and imaging unit are both MICR or non-MICR supplies.

Note: For the list of supported supplies, see the “Maintaining the printer” chapter of the *User’s Guide* or visit www.lexmark.com/regions.

- 2 Change the toner cartridge or imaging unit so that both are MICR or non-MICR supplies.

Notes:

- Use MICR toner cartridge and imaging unit for printing checks and other similar documents.
- Use non-MICR toner cartridge and imaging unit for regular print jobs.

Cartridge nearly low [88.xy]

If necessary, press  on the printer control panel to clear the message and continue printing.

Cartridge very low, [x] estimated pages remain [88.xy]

You may need to replace a toner cartridge very soon. For more information, see the “Replacing supplies” section of the *User’s Guide*.

If necessary, press  on the printer control panel to clear the message and continue printing.

Cartridge low [88.xy]

You may need to order a toner cartridge. If necessary, press  on the printer control panel to clear the message and continue printing.

Imaging unit nearly low [84.xy]

If necessary, press  on the printer control panel to clear the message and continue printing.

Imaging unit very low, [x] estimated pages remain [84.xy]

You may need to replace the imaging unit very soon. For more information, see the “Replacing supplies” section of the *User’s Guide*.

If necessary, press  on the printer control panel to clear the message and continue printing.

Imaging unit low [84.xy]

You may need to order an imaging unit. If necessary, press  on the printer control panel to clear the message and continue printing.

Change [paper source] to [custom type name]. Load [orientation].

Try one or more of the following:

- Load the correct size and type of paper in the tray, and then press  on the printer control panel.
Note: Make sure the paper size and type settings are specified in the Paper menu on the printer control panel.
- Cancel the print job.

Change [paper source] to [custom string]. Load [orientation].

Try one or more of the following:

- Load the correct size and type of paper in the tray, and then press  on the printer control panel.
Note: Make sure the paper size and type settings are specified in the Paper menu on the printer control panel.
- Cancel the print job.

Change [paper source] to [paper size]. Load [orientation].

Try one or more of the following:

- Load the correct size and type of paper in the tray, and then press  on the printer control panel.
Note: Make sure the paper size and type settings are specified in the Paper menu on the printer control panel.
- Cancel the print job.

Change [paper source] to [paper type] [paper size]. Load [orientation].

Try one or more of the following:

- Load the correct size and type of paper in the tray, and then press  on the printer control panel.
Note: Make sure the paper size and type settings are specified in the Paper menu on the printer control panel.
- Cancel the print job.

Close front door

Close the front door of the printer.

Complex page may misprint [39]

Try one or more of the following:

- From the printer control panel, press  to clear the message and continue printing.
- Reduce the number and size of fonts, the number and complexity of images, and the number of pages in the print job.
- Cancel the print job.
- Install additional printer memory.

Defective flash memory [51]

Try one or more of the following:

- Replace the defective flash memory card.
- From the printer control panel, press  to ignore the message and continue printing.
- Cancel the current print job.

Paper too short [34]

Try one or more of the following:

- Load the correct size of paper in the tray.
- From the printer control panel, press  to clear the message and print using a different tray.
- Check the tray length and width guides and make sure the paper is loaded properly in the tray.
- Make sure the correct paper size and type are specified in Print Properties or in the Print dialog.
- Make sure the paper size and type settings are specified in the Paper menu on the printer control panel.
- Make sure the paper size is correctly set. For example, if the MP Feeder Size is set to Universal, then make sure the paper is large enough for the data being printed.
- Cancel the print job.

Insert tray [x]

Insert the indicated tray into the printer.

Memory low, no Resource Save [35]

Try one or more of the following:

- From the printer control panel, press  to disable Resource Save, clear the message, and continue printing.
- Install additional printer memory.







Cannot collate large document [37]

Try one or more of the following:

- From the printer control panel, press  to print the portion of the job already stored and begin collating the rest of the print job.
- Cancel the current print job.

Cannot defrag flash memory [37]

Try one or more of the following:

- From the printer control panel, press  to stop the defragmentation and continue printing.
- Delete fonts, macros, and other data in the printer memory. From the printer control panel, navigate to:
 > **Settings** >  > **Print Settings** >  > **Utilities Menu** >  > **Format Flash** >  > **Yes** > 
- Install additional printer memory.

Load [paper source] with [custom type name] [orientation]

Try one or more of the following:

- Load the tray or feeder with the correct size and type of paper.
- From the printer control panel, press  to clear the message and continue printing.
Note: If the printer finds a tray that has the correct size and type of paper, then it feeds from that tray. If the printer cannot find a tray that has the correct size and type of paper, then it prints from the default paper source.
- Cancel the current job.

Load [paper source] with [custom string] [orientation]

Try one or more of the following:

- Load the indicated tray or feeder with the correct size and type of paper.
- From the printer control panel, press  to clear the message and continue printing.
Note: If the printer finds a tray that has the correct paper type and size, then it feeds from that tray. If the printer cannot find a tray that has the correct size and type of paper, then it prints from the default paper source.
- Cancel the current job.

Load [paper source] with [paper size] [orientation]

Try one or more of the following:

- Load the tray or feeder with the correct size of paper.
- From the printer control panel, press  to clear the message and continue printing.

Note: If the printer finds a tray that has the correct paper size, then it feeds from that tray. If the printer cannot find a tray that has the correct size of paper, then it prints from the default paper source.

- Cancel the current job.

Load [paper source] with [paper type] [paper size] [orientation]

Try one or more of the following:

- Load the tray or feeder with the correct size and type of paper.
- From the printer control panel, press  to clear the message and continue printing.

Note: If the printer finds a tray that has the correct size and type of paper, then it feeds from that tray. If the printer cannot find a tray that has the correct size and type of paper, then it prints from the default paper source.

- Cancel the current job.

Load MP feeder with [custom type name] [orientation]

Try one or more of the following:

- Load the feeder with the correct size and type of paper.
- From the printer control panel, press  to clear the message and continue printing.

Note: If no paper is loaded in the feeder, then the printer manually overrides the request, and then prints from an automatically selected tray.

- Cancel the current job.

Load MP feeder with [custom string] [orientation]

Try one or more of the following:

- Load the feeder with the correct size and type of paper.
- From the printer control panel, press  to clear the message and continue printing.

Note: If no paper is loaded in the feeder, then the printer manually overrides the request, and then prints from an automatically selected tray.

- Cancel the current job.

Load MP feeder with [paper size] [orientation]

Try one or more of the following:

- Load the feeder with the correct size of paper.
- From the printer control panel, press  to clear the message and continue printing.

Note: If no paper is loaded in the feeder, then the printer manually overrides the request, and then prints from an automatically selected tray.

- Cancel the current job.

Load MP feeder with [paper type] [paper size] [orientation]

Try one or more of the following:

- Load the feeder with the correct size and type of paper.
- From the printer control panel, press  to clear the message and continue printing.

Note: If no paper is loaded in the feeder, then the printer manually overrides the request, and then prints from an automatically selected tray.

- Cancel the current job.

Memory full [38]

Try one or more of the following:

- From the printer control panel, press  to clear the message.
- Decrease the resolution setting.
- Install additional printer memory.

Non-Lexmark [supply type], see User's Guide [33.xy]

Note: The supply type can either be a toner cartridge or imaging unit.



The printer has detected a non-Lexmark supply or part installed in the printer.

Your Lexmark printer is designed to function best with genuine Lexmark supplies and parts. Use of third-party supplies or parts may affect the performance, reliability, or life of the printer and its imaging components.

All life indicators are designed to function with Lexmark supplies and parts, and may deliver unpredictable results if third-party supplies or parts are used. Imaging component usage beyond the intended life may damage your Lexmark printer or associated components.

Warning—Potential Damage: Use of third-party supplies or parts can affect warranty coverage. Damage caused by the use of third-party supplies or parts are not covered by the warranty.

To accept any and all of these risks and to proceed with the use of non-genuine supplies or parts in your printer,

press  and  on the printer control panel simultaneously for 15 seconds to clear the message and continue printing.

If you do not wish to accept these risks, then remove the third-party supply or part from your printer, and then install a genuine Lexmark supply or part.

Note: For the list of supported supplies, see the “Ordering supplies” section of the *User's Guide* or visit <http://support.lexmark.com>.







Network error, port [x] [54]

Try one or more of the following:

- From the printer control panel, press  to clear the message and continue printing.
- Unplug the router, then wait for 30 seconds, and then plug it back again.
- Turn off the printer, then wait for about 10 seconds, and then turn the printer back on.
- Update the network firmware in the printer or the print server. For more information, contact customer support.

Flash memory full [52]

Try one or more of the following:

- From the printer control panel, press  to clear the message and continue printing.
- Delete fonts, macros, and other data stored in the flash memory. From the printer control panel, navigate to:
 > **Settings** >  > **Print Settings** >  > **Utilities Menu** >  > **Format Flash** >  > **Yes** > 
- Use a larger-capacity flash memory card.

Note: Downloaded fonts and macros that are not stored in the flash memory are deleted when the printer is powered off or restarted.

Replace cartridge, 0 estimated pages remain [88.xy]

Replace the toner cartridge to clear the message and continue printing. For more information, see the instruction sheet that came with the supply or see the “Replacing supplies” section of the *User's Guide*.

Note: If you do not have a replacement cartridge, then see the “Ordering supplies” section of the *User's Guide* or visit www.lexmark.com.

Printer restart. Check last job.

Press  on the printer control panel to clear the message and continue printing.

For more information, visit <http://support.lexmark.com> or contact customer support.

Replace cartridge, printer region mismatch [42.xy]

Install a toner cartridge that matches the region number of the printer. x indicates the value of the printer region. y indicates the value of the cartridge region. x and y can have the following values:

List of printer and toner cartridge regions

Region number	Region
0	Global
1	United States, Canada
2	European Economic Area (EEA), Switzerland
3	Asia Pacific, Australia, New Zealand
4	Latin America
5	Africa, Middle East, rest of Europe
9	Invalid

Notes:

- The x and y values are the .xy of the error code shown on the printer control panel.
- The x and y values must match for printing to continue.

Replace imaging unit, 0 estimated pages remain [84.xy]

Replace the imaging unit to clear the message and continue printing. For more information, see the instruction sheet that came with the supply or see the “Replacing supplies” section of the *User’s Guide*.

Note: If you do not have a replacement imaging unit, then see the “Ordering supplies” section of the *User’s Guide* or visit www.lexmark.com.

Reinstall missing or unresponsive cartridge [31.xy]

Try one or more of the following:

- Check if the toner cartridge is missing. If missing, install the toner cartridge.
For information on installing the cartridge, see the “Replacing supplies” section of the *User’s Guide*.
- If the toner cartridge is installed, then remove the unresponsive toner cartridge, and then reinstall it.
Note: If the message appears after reinstalling the supply, then the cartridge is defective. Replace the toner cartridge.

Reinstall missing or unresponsive imaging unit [31.xy]

Try one or more of the following:

- Check if the imaging unit is missing. If missing, install the imaging unit.
For information on installing the imaging unit, see the “Replacing supplies” section of the *User’s Guide*.
- If the imaging unit is installed, then remove the unresponsive imaging unit, and then reinstall it.
Note: If the message appears after reinstalling the supply, then the imaging unit is defective. Replace the imaging unit.

Replace unsupported cartridge [32.xy]

Remove the toner cartridge, and then install a supported one to clear the message and continue printing. For more information, see the instruction sheet that came with the supply or see the “Replacing supplies” section of the *User’s Guide*.

Note: If you do not have a replacement cartridge, then see the “Ordering supplies” section of the *User’s Guide* or visit www.lexmark.com.

Replace unsupported imaging unit [32.xy]

Remove the imaging unit, and then install a supported one to clear the message and continue printing. For more information, see the instruction sheet that came with the supply or see the “Replacing supplies” section of the *User’s Guide*.

Note: If you do not have a replacement imaging unit, then see the “Ordering supplies” section of the *User’s Guide* or visit www.lexmark.com.

Bin full. Remove paper.

Remove the paper stack from the standard bin.

Network error, standard port [54]

Try one or more of the following:

- From the printer control panel, press  to clear the message and continue printing.
- Unplug the router, then wait for 30 seconds, and then plug it back again.
- Turn off the printer, then wait for about 10 seconds, and then turn the printer back on.
- Update the network firmware in the printer or the print server. For more information, contact customer support.

Parallel port disabled [56]

Try one or more of the following:

- From the printer control panel, press  to clear the message and continue printing.
Note: The printer discards any data received through the parallel port.
- From the printer control panel, set Parallel Buffer to Auto.

Rear USB port disabled [56]

Try one or more of the following:

- From the printer control panel, press  to clear the message and continue printing.
Note: The printer discards any data received through the USB port.
- From the printer control panel, set USB Buffer to Auto.

Too many trays. Remove some. [58]

- 1 Turn off the printer.
- 2 Unplug the power cord from the electrical outlet.
- 3 Remove the extra trays.
- 4 Connect the power cord to the electrical outlet.
- 5 Turn the printer back on.

Flash memory unformatted [53]

Try one or more of the following:

- From the printer control panel, press  to stop the defragmentation and continue printing.
- Format the flash memory device.

Note: If the error message remains, then the flash memory device may be defective and need to be replaced.

Solving printer problems

- “Basic printer problems” on page 123
- “Option problems” on page 125
- “Paper feed problems” on page 128

Basic printer problems

The printer is not responding

Action	Yes	No
<p>Step 1 Make sure the printer is turned on.</p> <p>Is the printer turned on?</p>	Go to step 2.	Turn on the printer.
<p>Step 2 Check if the printer is in Sleep mode or Hibernate mode.</p> <p>Is the printer in Sleep mode or Hibernate mode?</p>	Press the Sleep button to wake the printer from Sleep mode or Hibernate mode.	Go to step 3.
<p>Step 3 Check if one end of the power cord is plugged into the printer and the other to a properly grounded electrical outlet.</p> <p>Is the power cord plugged into the printer and a properly grounded electrical outlet?</p>	Go to step 4.	Plug one end of the power cord into the printer and the other to a properly grounded electrical outlet.

Action	Yes	No
<p>Step 4 Check other electrical equipment plugged into the electrical outlet.</p> <p>Does other electrical equipment work?</p>	Unplug the other electrical equipment, and then turn on the printer. If the printer does not work, then reconnect the other electrical equipment.	Go to step 5.
<p>Step 5 Check if the cables connecting the printer and the computer are inserted in the correct ports.</p> <p>Are the cables inserted in the correct ports?</p>	Go to step 6.	<p>Make sure to match the following:</p> <ul style="list-style-type: none"> • The USB symbol on the cable with the USB symbol on the printer • The appropriate Ethernet cable with the Ethernet port
<p>Step 6 Make sure the electrical outlet is not turned off by a switch or breaker.</p> <p>Is the electrical outlet turned off by a switch or breaker?</p>	Turn on the switch or reset the breaker.	Go to step 7.
<p>Step 7 Check if the printer is plugged into any surge protectors, uninterruptible power supplies, or extension cords.</p> <p>Is the printer plugged into any surge protectors, uninterruptible power supplies, or extension cords?</p>	Connect the printer power cord directly to a properly grounded electrical outlet.	Go to step 8.
<p>Step 8 Check if one end of the printer cable is plugged into a port on the printer and the other to the computer, print server, option, or other network device.</p> <p>Is the printer cable securely attached to the printer and the computer, print server, option, or other network device?</p>	Go to step 9.	Connect the printer cable securely to the printer and the computer, print server, option, or other network device.
<p>Step 9 Make sure to install all hardware options properly and remove any packing material.</p> <p>Are all hardware options properly installed and all packing material removed?</p>	Go to step 10.	Turn off the printer, remove all packing materials, then reinstall the hardware options, and then turn on the printer.
<p>Step 10 Check if you have selected the correct port settings in the printer driver.</p> <p>Are the port settings correct?</p>	Go to step 11.	Use correct printer driver settings.

Action	Yes	No
<p>Step 11 Check the installed printer driver.</p> <p>Is the correct printer driver installed?</p>	Go to step 12.	Install the correct printer driver.
<p>Step 12 Turn off the printer, then wait for about 10 seconds, and then turn the printer back on.</p> <p>Is the printer working?</p>	The problem is solved.	Contact customer support .

Printer display is blank

Action	Yes	No
<p>Step 1 Press the Sleep button on the printer control panel.</p> <p>Does Ready appear on the printer display?</p>	The problem is solved.	Go to step 2.
<p>Step 2 Turn off the printer, then wait for about 10 seconds, and then turn the printer back on.</p> <p>Do Please wait and Ready appear on the printer display?</p>	The problem is solved.	Turn off the printer, and then contact customer support .

Option problems

Cannot detect internal option

Action	Yes	No
<p>Step 1 Turn off the printer, then wait for about 10 seconds, and then turn on the printer.</p> <p>Does the internal option operate correctly?</p>	The problem is solved.	Go to step 2.
<p>Step 2 Check if the internal option is properly installed in the controller board.</p> <ul style="list-style-type: none"> a Turn off the printer using the power switch, and then unplug the power cord from the electrical outlet. b Make sure the internal option is installed in the appropriate connector in the controller board. c Connect the power cord to the printer, then to a properly grounded electrical outlet, and then turn on the printer. <p>Is the internal option properly installed in the controller board?</p>	Go to step 3.	Connect the internal option to the controller board.

Action	Yes	No
<p>Step 3 Print a menu settings page, and then check to see if the internal option is listed in the Installed Features list.</p> <p>Is the internal option listed in the menu settings page?</p>	Go to step 4.	Reinstall the internal option.
<p>Step 4</p> <p>a Check if the internal option is selected. It may be necessary to manually add the internal option in the printer driver to make it available for print jobs. For more information, see “Updating available options in the printer driver” on page 22.</p> <p>b Resend the print job.</p> <p>Does the internal option operate correctly?</p>	The problem is solved.	Contact customer support .

Tray problems

Action	Yes	No
<p>Step 1</p> <p>a Open the tray and do one or more of the following:</p> <ul style="list-style-type: none"> • Check for paper jams or misfeeds. • Check if the paper size indicators on the paper guides are aligned with the paper size indicators on the tray. • If you are printing on custom-size paper, then make sure that the paper guides rest against the edges of the paper. • Make sure the paper is below the maximum paper fill indicator. • Make sure paper lies flat in the tray. <p>b Check if the tray closes properly.</p> <p>Is the tray working?</p>	The problem is solved.	Go to step 2.
<p>Step 2</p> <p>a Turn off the printer, then wait about 10 seconds, and then turn the printer back on.</p> <p>b Resend the print job.</p> <p>Is the tray working?</p>	The problem is solved.	Go to step 3.
<p>Step 3 Check if the tray is installed. Print a menu settings page, and then check if the tray is listed in the Installed Options list.</p> <p>Is the tray listed in the menu settings page?</p>	Go to step 4.	Reinstall the tray. For more information, see the setup documentation that came with the tray.

Action	Yes	No
<p>Step 4 Check if the tray is available in the printer driver.</p> <p>Note: If necessary, manually add the tray in the printer driver to make it available for print jobs. For more information, see “Updating available options in the printer driver” on page 22.</p> <p>Is the tray available in the printer driver?</p>	Go to step 5.	Manually add the tray in the printer driver.
<p>Step 5 Check if the option is selected.</p> <p>a From the application you are using, select the option. For Mac OS X version 9 users, make sure the printer is set up in Chooser.</p> <p>b Resend the print job.</p> <p>Is the tray working?</p>	The problem is solved.	Contact customer support .

Cannot detect memory card

Action	Yes	No
<p>Make sure the memory card is installed.</p> <p>a Install the memory card. For more information, see “Installing a memory card” on page 15.</p> <p>Note: Check if the memory card is securely connected to the printer controller board.</p> <p>b Print a menu settings page, and then check if the card is listed in the Installed Options list.</p> <p>Is the card listed in the Installed Options list?</p>	The problem is solved.	Contact customer support .

Paper feed problems







Paper frequently jams

Action	Yes	No
<p>Step 1</p> <p>a Pull out the tray, and then do one or more of the following:</p> <ul style="list-style-type: none"> • Make sure paper lies flat in the tray. • Check if the paper size indicators on the paper guides are aligned with the paper size indicators on the tray. • Check if the paper guides are aligned against the edges of the paper. • Make sure the paper is below the maximum paper fill indicator. • Check if you are printing on a recommended paper size and type. <p>b Insert the tray properly. If jam recovery is enabled, then the print jobs will reprint automatically.</p> <p>Do paper jams still occur frequently?</p>	Go to step 2.	The problem is solved.
<p>Step 2</p> <p>a Load paper from a fresh package. Note: Paper absorbs moisture due to high humidity. Store paper in its original wrapper until you use it.</p> <p>b Resend the print job.</p> <p>Do paper jams still occur frequently?</p>	Go to step 3.	The problem is solved.
<p>Step 3</p> <p>a Review the tips on avoiding jams. For more information, see “Avoiding jams” on page 103.</p> <p>b Follow the recommendations, and then resend the print job.</p> <p>Do paper jams still occur frequently?</p>	Contact customer support .	The problem is solved.

Paper jam message remains after jam is cleared

Action	Yes	No
<p>Open front door and remove all trays.</p> <p>a Clear any jammed pages. Note: Make sure all paper fragments are removed.</p> <p>b Press  to clear the message and continue printing.</p> <p>Does the paper jam message remain?</p>	Contact customer support .	The problem is solved.

Jammed pages are not reprinted

Action	Yes	No
<p>a Turn on jam recovery.</p> <p>1 From the printer control panel, navigate to:</p> <p> > Settings >  > General Settings >  > Print Recovery >  > Jam Recovery > </p> <p>2 Press the arrow buttons until On or Auto appears, and then press .</p> <p>b Resend the pages that did not print.</p> <p>Were the jammed pages reprinted?</p>	The problem is solved.	Contact customer support .

Solving print problems

Printing problems

Print jobs do not print

Action	Yes	No
<p>Step 1</p> <p>a From the document you are trying to print, open the Print dialog and check if you have selected the correct printer.</p> <p>Note: If the printer is not the default printer, then you must select the printer for each document that you want to print.</p> <p>b Resend the print job.</p> <p>Do the jobs print?</p>	The problem is solved.	Go to step 2.
<p>Step 2</p> <p>a Check if the printer is plugged in and turned on, and if Ready appears on the printer display.</p> <p>b Resend the print job.</p> <p>Do the jobs print?</p>	The problem is solved.	Go to step 3.
<p>Step 3</p> <p>If an error message appears on the printer display, then clear the message.</p> <p>Note: The printer continues to print after clearing the message.</p> <p>Do the jobs print?</p>	The problem is solved.	Go to step 4.

Action	Yes	No
<p>Step 4</p> <p>a Check if the ports (USB, serial, or Ethernet) are working and if the cables are securely connected to the computer and the printer.</p> <p>Note: For more information, see the setup documentation that came with the printer.</p> <p>b Resend the print job.</p> <p>Do the jobs print?</p>	The problem is solved.	Go to step 5.
<p>Step 5</p> <p>a Turn off the printer, then wait for about 10 seconds, and then turn the printer back on.</p> <p>b Resend the print job.</p> <p>Do the jobs print?</p>	The problem is solved.	Go to step 6.
<p>Step 6</p> <p>a Remove, and then reinstall the printer software. For more information, see “Installing the printer software” on page 21.</p> <p>Note: The printer software is available at http://support.lexmark.com.</p> <p>b Resend the print job.</p> <p>Do the jobs print?</p>	The problem is solved.	Contact customer support .











Printing slows down

Notes:

- When printing using narrow paper, the printer prints at a reduced speed to prevent damage to the fuser.
- The printer speed may be reduced when printing for long periods of time, or printing at elevated temperatures.
- The printer speed may also be reduced when the printed output resolution is set to 1,200 dpi.

Action	Yes	No
<p>Place letter- or A4-size paper in the tray, and then resend the print job.</p> <p>Does the print speed increase?</p>	The problem is solved.	Contact customer support .

Print job takes longer than expected

Action	Yes	No
<p>Step 1 Reduce the number and size of fonts, the number and complexity of images, and the number of pages in the print job, and then resend the print job.</p> <p>Does the print job still take long?</p>	Go to step 2.	The problem is solved.
<p>Step 2 Disable the Page Protect feature.</p> <p>From the printer control panel, navigate to:</p> <p> > Settings >  > General Settings >  > Print Recovery >  > Page Protect >  > Off > </p> <p>Does the print job still take long?</p>	Go to step 3.	The problem is solved.
<p>Step 3 Change the environmental settings.</p> <p>From the printer control panel, navigate to:</p> <p> > Settings >  > General Settings >  > Eco-Mode > select a setting > </p> <p>Note: When using the Eco-Mode setting, you may notice a reduction in performance.</p> <p>Does the print job still take long?</p>	Install additional printer memory. For more information, contact customer support .	The problem is solved.

Job prints from the wrong tray or on the wrong paper

Action	Yes	No
<p>Step 1</p> <ul style="list-style-type: none"> a Check if you are printing on paper that is supported by the tray. b Resend the print job. <p>Did the job print from the correct tray or on the correct paper?</p>	The problem is solved.	Go to step 2.
<p>Step 2</p> <ul style="list-style-type: none"> a From the Paper menu on the printer control panel, set the paper size and type to match the paper loaded in the tray. b Resend the print job. <p>Did the job print from the correct tray or on the correct paper?</p>	The problem is solved.	Go to step 3.

Action	Yes	No
<p>Step 3</p> <p>a Depending on your operating system, open Printing Preferences or the Print dialog, and then specify the paper type.</p> <p>b Resend the print job.</p> <p>Did the job print from the correct tray or on the correct paper?</p>	The problem is solved.	Go to step 4.
<p>Step 4</p> <p>a Check if the trays are not linked.</p> <p>b Resend the print job.</p> <p>Did the job print from the correct tray or on the correct paper?</p>	The problem is solved.	Contact customer support .

Incorrect characters print

Action	Yes	No
<p>Step 1</p> <p>Make sure the printer is not in Hex Trace mode.</p> <p>Note: If Ready Hex appears on the printer display, then turn off the printer, and then turn it back on to deactivate Hex Trace mode.</p> <p>Is the printer in Hex Trace mode?</p>	Deactivate Hex Trace mode.	Go to step 2.
<p>Step 2</p> <p>a From the printer control panel, select Standard Network or Network [x], and then set SmartSwitch to On.</p> <p>b Resend the print job.</p> <p>Do incorrect characters print?</p>	Contact customer support .	The problem is solved.

Tray linking does not work

Note: The trays and the multipurpose feeder do not automatically detect the paper size. You must set the size from the Paper Size/Type menu.

Action	Yes	No
<p>a From the printer control panel, set the paper size and type in the Paper menu to match the paper loaded in the trays to be linked.</p> <p>Note: The paper size and type must match for trays to be linked.</p> <p>b Resend the print job.</p> <p>Do the trays link correctly?</p>	The problem is solved.	Contact customer support .

Large jobs do not collate

Action	Yes	No
<p>Step 1</p> <p>a From the Finishing menu on the printer control panel, set Collate to (1,2,3) (1,2,3).</p> <p>b Resend the print job.</p> <p>Did the job print and collate correctly?</p>	The problem is solved.	Go to step 2.
<p>Step 2</p> <p>a From the printer software, set Collate to (1,2,3) (1,2,3).</p> <p>Note: Setting Collate to (1,1,1) (2,2,2) in the software overrides the setting in the Finishing menu.</p> <p>b Resend the print job.</p> <p>Did the job print and collate correctly?</p>	The problem is solved.	Go to step 3.
<p>Step 3</p> <p>Reduce the complexity of the print job by eliminating the number and size of fonts, the number and complexity of images, and the number of pages in the job.</p> <p>Did the job print and collate correctly?</p>	The problem is solved.	Contact customer support .





Unexpected page breaks occur

Action	Yes	No
<p>Step 1</p> <p>Adjust the print timeout settings.</p> <p>a From the printer control panel, navigate to: Settings > General Settings > Timeouts > Print Timeout</p> <p>b Select a higher setting and then, depending on your printer model, select  or Submit.</p> <p>c Resend the print job.</p> <p>Did the file print correctly?</p>	The problem is solved.	Go to step 2.
<p>Step 2</p> <p>a Check the original file for manual page breaks.</p> <p>b Resend the print job.</p> <p>Did the file print correctly?</p>	The problem is solved.	Contact customer support .

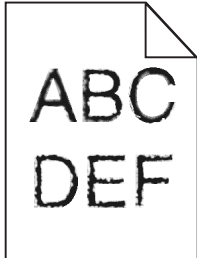
Print quality problems

Characters have jagged or uneven edges



Action	Yes	No
<p>Step 1</p> <p>a Print a font sample list to check if the fonts you are using are supported by the printer.</p> <p>1 From the printer control panel, navigate to:</p> <p> > Reports >  > Print Fonts > </p> <p>2 Press the arrow buttons until PCL Fonts or PostScript Fonts appears, and then press .</p> <p>b Use a font that is supported by the printer or install the font that you want to use. For more information, contact your system support person.</p> <p>c Resend the print job.</p> <p>Do prints still contain characters that have jagged or uneven edges?</p>	<p>Go to step 2.</p>	<p>The problem is solved.</p>
<p>Step 2</p> <p>a Use a font that is supported by the printer or install the font that you want to use in your computer. For more information, contact your system support person.</p> <p>b Resend the print job.</p> <p>Do prints still contain characters that have jagged or uneven edges?</p>	<p>Contact customer support.</p>	<p>The problem is solved.</p>

Printer is printing blank pages

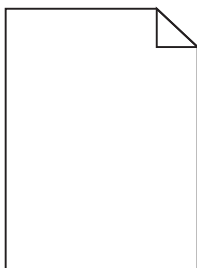

Action	Yes	No
<p>Step 1</p> <p>a Check if there is packing material left on the imaging unit.</p> <ol style="list-style-type: none"> 1 Remove the toner cartridge, and then the imaging unit. 2 Check if the packing material is properly removed from the imaging unit. <p>Warning—Potential Damage: Do not expose the imaging unit to direct light for more than 10 minutes. Extended exposure to light may cause print quality problems.</p> <ol style="list-style-type: none"> 3 Reinstall the imaging unit, and then the cartridge. <p>b Resend the print job.</p> <p>Is the printer still printing blank pages?</p>	Go to step 2.	The problem is solved.
<p>Step 2</p> <p>a Redistribute the toner in the imaging unit.</p> <ol style="list-style-type: none"> 1 Remove the toner cartridge, and then the imaging unit. 2 Firmly shake the imaging unit. <p>Warning—Potential Damage: Do not expose the imaging unit to direct light for more than 10 minutes. Extended exposure to light may cause print quality problems.</p> <ol style="list-style-type: none"> 3 Reinstall the imaging unit, and then the cartridge. <p>b Resend the print job.</p> <p>Is the printer still printing blank pages?</p>	Go to step 3.	The problem is solved.
<p>Step 3</p> <p>Replace the imaging unit, and then resend the print job.</p> <p>Is the printer still printing blank pages?</p>	Contact customer support .	The problem is solved.

Clipped pages or images

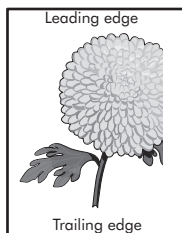
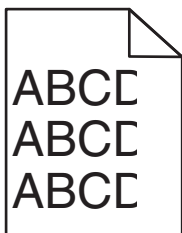

Action	Yes	No
<p>Step 1</p> <p>a Move the width and length guides in the tray to the correct positions for the paper loaded.</p> <p>b Resend the print job.</p> <p>Is the page or image clipped?</p>	Go to step 2.	The problem is solved.
<p>Step 2</p> <p>From the printer control panel, set the paper size and type in the Paper menu to match the paper loaded in the tray.</p> <p>Do the paper size and type match the paper loaded in the tray?</p>	Go to step 3.	<p>Do one or more of the following:</p> <ul style="list-style-type: none"> • Specify the paper size from the tray settings to match the paper loaded in the tray. • Change the paper loaded in the tray to match the paper size specified in the tray settings.
<p>Step 3</p> <p>a Depending on your operating system, specify the paper size from Printing Preferences or from the Print dialog.</p> <p>b Resend the print job.</p> <p>Is the page or image clipped?</p>	Go to step 4.	The problem is solved.
<p>Step 4</p> <p>a Reinstall the imaging unit.</p> <ol style="list-style-type: none"> 1 Remove the toner cartridge. 2 Remove the imaging unit. <p>Warning—Potential Damage: Do not expose the imaging unit to direct light for more than 10 minutes. Extended exposure to light may cause print quality problems.</p> <ol style="list-style-type: none"> 3 Install the imaging unit, and then the cartridge. <p>b Resend the print job.</p> <p>Is the page or image clipped?</p>	Contact customer support .	The problem is solved.

Shadow images appear on prints

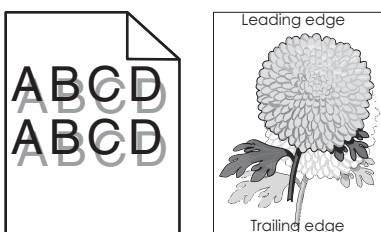

Action	Yes	No
<p>Step 1 Load paper with the correct paper type and weight in the tray.</p> <p>Is paper with the correct paper type and weight loaded in the tray?</p>	Go to step 2.	Load paper with the correct paper type and weight in the tray.
<p>Step 2 From the printer control panel, set the paper type and weight in the Paper menu to match the paper loaded in the tray.</p> <p>Is the tray set to the type and weight of the paper loaded?</p>	Go to step 3.	Change the paper loaded in the tray to match the paper type and weight specified in the tray settings.
<p>Step 3</p> <p>a Depending on your operating system, specify the paper type and weight from Printing Preferences or from the Print dialog.</p> <p>b Resend the print job.</p> <p>Do shadow images still appear on prints?</p>	Go to step 4.	The problem is solved.
<p>Step 4 Replace the imaging unit, and then resend the print job.</p> <p>Do shadow images still appear on prints?</p>	Contact customer support .	The problem is solved.

Gray background on prints

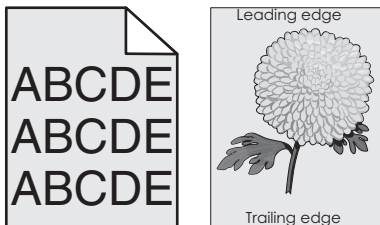

Action	Yes	No
<p>Step 1</p> <p>a From the Quality Menu on the printer control panel, decrease the toner darkness. Note: 8 is the factory default setting.</p> <p>b Resend the print job.</p> <p>Did the gray background disappear from the prints?</p>	The problem is solved.	Go to step 2.

Action	Yes	No
<p>Step 2 Reinstall the imaging unit and the toner cartridge.</p> <p>a Remove the toner cartridge. b Remove the imaging unit.</p> <p>Warning—Potential Damage: Do not expose the imaging unit to direct light for more than 10 minutes. Extended exposure to light can cause print quality problems.</p> <p>c Install the imaging unit, and then the cartridge. d Resend the print job.</p> <p>Did the gray background disappear from the prints?</p>	The problem is solved.	Go to step 3.
<p>Step 3 Replace the imaging unit, and then resend the print job.</p> <p>Did the gray background disappear from the prints?</p>	The problem is solved.	Contact customer support .

Incorrect margins on prints

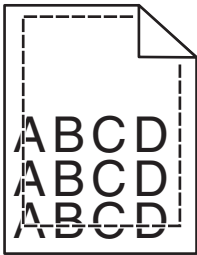

Action	Yes	No
<p>Step 1</p> <p>a Move the width and length guides in the tray to the correct positions for the paper size loaded. b Resend the print job.</p> <p>Are the margins correct?</p>	The problem is solved.	Go to step 2.
<p>Step 2 From the printer control panel, set the paper size in the Paper menu to match the paper loaded in the tray.</p> <p>Does the paper size match the paper loaded in the tray?</p>	Go to step 3.	<p>Do one or more of the following:</p> <ul style="list-style-type: none"> Specify the paper size from the tray settings to match the paper loaded in the tray. Change the paper loaded in the tray to match the paper size specified in the tray settings.

Action	Yes	No
<p>Step 3</p> <p>a Depending on your operating system, specify the paper size from Printing Preferences or from the Print dialog.</p> <p>b Resend the print job.</p> <p>Are the margins correct?</p>	The problem is solved.	Contact customer support .

Paper curl

Action	Yes	No
<p>Step 1</p> <p>Move the width and length guides in the tray to the correct positions for the size of the paper loaded.</p> <p>Are the width and length guides positioned correctly?</p>	Go to step 2.	Adjust the width and length guides.
<p>Step 2</p> <p>From the printer control panel, set the paper type and weight in the Paper menu to match the paper loaded in the tray.</p> <p>Do the paper type and weight match the type and weight of the paper in the tray?</p>	Go to step 3.	Specify the paper type and weight from the tray settings to match the paper loaded in the tray.
<p>Step 3</p> <p>a Depending on your operating system, specify the paper type and weight from Printing Preferences or from the Print dialog.</p> <p>b Resend the print job.</p> <p>Is the paper still curled?</p>	Go to step 4.	The problem is solved.
<p>Step 4</p> <p>a Remove the paper from the tray, and then turn it over.</p> <p>b Resend the print job.</p> <p>Is the paper still curled?</p>	Go to step 5.	The problem is solved.
<p>Step 5</p> <p>a Load paper from a fresh package.</p> <p>Note: Paper absorbs moisture due to high humidity. Store paper in its original wrapper until you use it.</p> <p>b Resend the print job.</p> <p>Is the paper still curled?</p>	Contact customer support .	The problem is solved.

Print irregularities

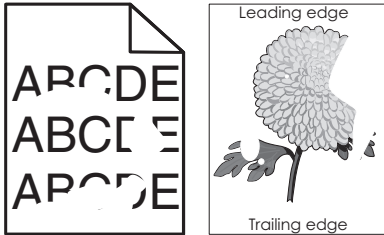

Action	Yes	No
<p>Step 1</p> <p>a Move the width and length guides in the tray to the correct positions for the size of the paper loaded in the tray.</p> <p>b Resend the print job.</p> <p>Do print irregularities still appear?</p>	Go to step 2.	The problem is solved.
<p>Step 2</p> <p>From the printer control panel, set the paper size and type in the Paper menu to match the paper loaded in the tray.</p> <p>Do the printer settings match the type and weight of the paper loaded in the tray?</p>	Go to step 3.	Specify the paper size and type from the tray settings to match the paper loaded in the tray.
<p>Step 3</p> <p>a Depending on your operating system, specify the paper type and weight from Printing Preferences or from the Print dialog.</p> <p>b Resend the print job.</p> <p>Do print irregularities still appear?</p>	Go to step 4.	The problem is solved.
<p>Step 4</p> <p>Check if the paper loaded in the tray has texture or rough finishes.</p> <p>Are you printing on textured or rough paper?</p>	From the printer control panel, set the paper texture in the Paper menu to match the paper loaded in the tray.	Go to step 5.
<p>Step 5</p> <p>a Load paper from a fresh package.</p> <p>Note: Paper absorbs moisture due to high humidity. Store paper in its original wrapper until you use it.</p> <p>b Resend the print job.</p> <p>Do print irregularities still appear?</p>	Go to step 6.	The problem is solved.
<p>Step 6</p> <p>Replace the imaging unit, and then resend the print job.</p> <p>Do print irregularities still appear?</p>	Contact customer support at http://support.lexmark.com or your service representative.	The problem is solved.

Repeating defects appear on prints

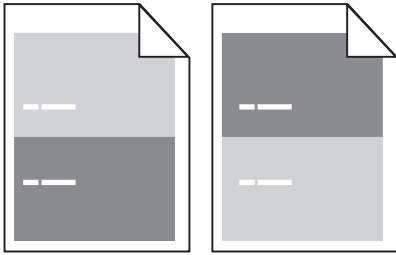

Action	Yes	No
<p>Step 1 Measure the distance between the defects. Check for a distance between the defects that equals:</p> <ul style="list-style-type: none"> • 97 mm (3.82 in.) • 47 mm (1.85 in.) • 38 mm (1.5 in.) <p>Is the distance between defects equal to one of the listed measurements?</p>	<p>Go to step 2.</p>	<p>1 Check if the distance between the defects equal to 80 mm (3.15 in.)</p> <p>2 Take note of the distance, and then contact customer support at http://support.lexmark.com or your service representative.</p>
<p>Step 2 Replace the imaging unit, and then resend the print job.</p> <p>Do the repeating defects still appear?</p>	<p>Contact customer support at http://support.lexmark.com or your service representative.</p>	<p>The problem is solved.</p>

Print is too dark

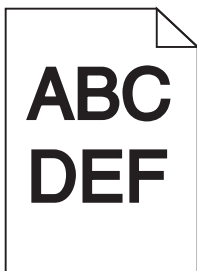

Action	Yes	No
<p>Step 1</p> <p>a From the Quality menu on the printer control panel, reduce the toner darkness.</p> <p>Note: 8 is the factory default setting.</p> <p>b Resend the print job.</p> <p>Is the print still too dark?</p>	<p>Go to step 2.</p>	<p>The problem is solved.</p>

Action	Yes	No
<p>Step 2</p> <p>a From the printer control panel, set the paper type, texture and weight in the Paper menu to match the paper loaded in the tray.</p> <p>b Resend the print job.</p> <p>Is the tray set to the type, texture, and weight of the paper loaded?</p>	<p>Go to step 3.</p>	<p>Do one or more of the following:</p> <ul style="list-style-type: none"> • Specify the paper type, texture, and weight from the tray settings to match the paper loaded in the tray. • Change the paper loaded in the tray to match the paper type, texture and weight specified in the tray settings.
<p>Step 3</p> <p>a Depending on your operating system, specify the paper type, texture and weight from Printing Preferences or from the Print dialog.</p> <p>b Resend the print job.</p> <p>Is the print still too dark?</p>	<p>Go to step 4.</p>	<p>The problem is solved.</p>
<p>Step 4</p> <p>Check if the paper loaded in the tray has texture or rough finishes.</p> <p>Are you printing on textured or rough paper?</p>	<p>From the printer control panel, change the texture settings in the Paper Texture menu to match the paper you are printing on.</p>	<p>Go to step 5.</p>
<p>Step 5</p> <p>a Load paper from a fresh package.</p> <p>Note: Paper absorbs moisture due to high humidity. Store paper in its original wrapper until you use it.</p> <p>b Resend the print job.</p> <p>Is the print still too dark?</p>	<p>Go to step 6.</p>	<p>The problem is solved.</p>
<p>Step 6</p> <p>Replace the imaging unit, and then resend the print job.</p> <p>Is the print still too dark?</p>	<p>Contact customer support.</p>	<p>The problem is solved.</p>

Print is too light



Action	Yes	No
<p>Step 1</p> <p>a From the Quality menu on the printer control panel, increase the toner darkness.</p> <p>Note: 8 is the factory default setting.</p> <p>b Resend the print job.</p> <p>Is the print still too light?</p>	Go to step 2.	The problem is solved.
<p>Step 2</p> <p>From the printer control panel, set the paper type, texture, and weight in the Paper menu to match the paper loaded in the tray.</p> <p>Is the tray set to the type, texture, and weight of the paper loaded?</p>	Go to step 3.	Change the paper type, texture, and weight to match the paper loaded in the tray.
<p>Step 3</p> <p>a Depending on your operating system, specify the paper type, texture, and weight from Printing Preferences or from the Print dialog.</p> <p>b Resend the print job.</p> <p>Is the print still too light?</p>	Go to step 4.	The problem is solved.
<p>Step 4</p> <p>Make sure that the paper has no texture or rough finishes.</p> <p>Are you printing on textured or rough paper?</p>	From the printer control panel, change the texture settings in the Paper Texture menu to match the paper you are printing on.	Go to step 5.
<p>Step 5</p> <p>a Load paper from a fresh package.</p> <p>Note: Paper absorbs moisture due to high humidity. Store paper in its original wrapper until you use it.</p> <p>b Resend the print job.</p> <p>Is the print still too light?</p>	Go to step 6.	The problem is solved.

Action	Yes	No
<p>Step 6</p> <p>a Redistribute the toner in the imaging unit.</p> <ol style="list-style-type: none"> 1 Remove the toner cartridge, and then the imaging unit. 2 Firmly shake the imaging unit. <p>Warning—Potential Damage: Do not expose the imaging unit to direct light for more than 10 minutes. Extended exposure to light may cause print quality problems.</p> <ol style="list-style-type: none"> 3 Install the imaging unit, and then the cartridge. <p>b Resend the print job.</p> <p>Is the print still too light?</p>	Go to step 7.	The problem is solved.
<p>Step 7</p> <p>Replace the imaging unit, and then resend the print job.</p> <p>Is the print still too light?</p>	Contact customer support .	The problem is solved.

Skewed print

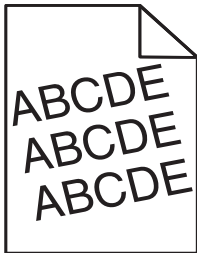

Action	Yes	No
<p>Step 1</p> <p>a Move the width and length guides in the tray to the correct positions for the size of the paper loaded.</p> <p>b Resend the print job.</p> <p>Is the print still skewed?</p>	Go to step 2.	The problem is solved.
<p>Step 2</p> <p>a Check if you are printing on a paper that is supported by the tray.</p> <p>b Resend the print job.</p> <p>Is the print still skewed?</p>	Contact customer support .	The problem is solved.

Printer is printing solid black pages



Action	Yes	No
<p>Step 1</p> <p>a Reinstall the imaging unit.</p> <p>1 Remove the toner cartridge, and then the imaging unit.</p> <p>Warning—Potential Damage: Do not expose the imaging unit to direct light for more than 10 minutes. Extended exposure to light may cause print quality problems.</p> <p>2 Install the imaging unit, and then the cartridge.</p> <p>b Resend the print job.</p> <p>Is the printer printing solid black pages?</p>	Go to step 2.	The problem is solved.
<p>Step 2</p> <p>Replace the imaging unit, and then resend the print job.</p> <p>Is the printer printing solid black pages?</p>	Contact customer support .	The problem is solved.

Transparency print quality is poor

Action	Yes	No
<p>Step 1</p> <p>From the printer control panel, set the paper type in the Paper menu to match the paper loaded in the tray.</p> <p>Is the paper type for the tray set to Transparency?</p>	Go to step 2.	Set the paper type to Transparency.
<p>Step 2</p> <p>a Check if you are using a recommended type of transparency.</p> <p>b Resend the print job.</p> <p>Is the print quality still poor?</p>	Contact customer support .	The problem is solved.

Streaked horizontal lines appear on prints

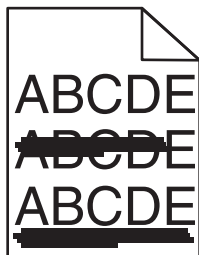

Action	Yes	No
<p>Step 1</p> <ul style="list-style-type: none"> a Depending on your operating system, specify the tray or feeder from Printing Preferences or the Print dialog. b Resend the print job. <p>Do streaked horizontal lines appear on prints?</p>	Go to step 2.	The problem is solved.
<p>Step 2</p> <p>From the printer control panel, set the paper type and weight in the Paper menu to match the paper loaded in the tray.</p> <p>Do the paper type and weight match the type and weight of the paper in the tray?</p>	Go to step 3.	Change the paper type and weight to match the paper loaded in the tray.
<p>Step 3</p> <ul style="list-style-type: none"> a Load paper from a fresh package. <p>Note: Paper absorbs moisture due to high humidity. Store paper in its original wrapper until you use it.</p> b Resend the print job. <p>Do streaked horizontal lines appear on prints?</p>	Go to step 4.	The problem is solved.
<p>Step 4</p> <ul style="list-style-type: none"> a Reinstall the imaging unit. <ul style="list-style-type: none"> 1 Remove the toner cartridge, and then the imaging unit. <p>Warning—Potential Damage: Do not expose the imaging unit to direct light for more than 10 minutes. Extended exposure to light may cause print quality problems.</p> 2 Install the imaging unit, and then the cartridge. b Resend the print job. <p>Do streaked horizontal lines appear on prints?</p>	Go to step 5.	The problem is solved.
<p>Step 5</p> <p>Replace the imaging unit, and then resend the print job.</p> <p>Do streaked horizontal lines appear on prints?</p>	Contact customer support .	The problem is solved.

Streaked vertical lines appear on prints

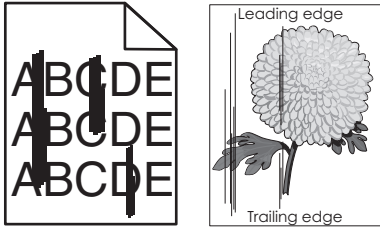

Action	Yes	No
<p>Step 1</p> <p>a Depending on your operating system, specify the paper type, texture, and weight from Printing Preferences or from the Print dialog.</p> <p>b Resend the print job.</p> <p>Do streaked vertical lines appear on prints?</p>	Go to step 2.	The problem is solved.
<p>Step 2</p> <p>From the printer control panel, set the paper texture, type, and weight in the Paper menu to match the paper loaded in the tray.</p> <p>Do the paper texture, type, and weight match the paper in the tray?</p>	Go to step 3.	<p>Do one or more of the following:</p> <ul style="list-style-type: none"> Specify the paper texture, type, and weight from the tray settings to match the paper loaded in the tray. Change the paper loaded in the tray to match the paper texture, type, and weight specified in the tray settings.
<p>Step 3</p> <p>a Load paper from a fresh package.</p> <p>Note: Paper absorbs moisture due to high humidity. Store paper in its original wrapper until you use it.</p> <p>b Resend the print job.</p> <p>Do streaked vertical lines appear on prints?</p>	Go to step 4.	The problem is solved.
<p>Step 4</p> <p>a Reinstall the imaging unit.</p> <p>1 Remove the toner cartridge, and then the imaging unit.</p> <p>Warning—Potential Damage: Do not expose the imaging unit to direct light for more than 10 minutes. Extended exposure to light may cause print quality problems.</p> <p>2 Install the imaging unit, and then the cartridge.</p> <p>b Resend the print job.</p> <p>Do streaked vertical lines appear on prints?</p>	Go to step 5.	The problem is solved.

Action	Yes	No
<p>Step 5 Replace the imaging unit, and then resend the print job.</p> <p>Do streaked vertical lines appear on prints?</p>	<p>Contact customer support at http://support.lexmark.com or your service representative.</p>	<p>The problem is solved.</p>

Horizontal voids appear on prints

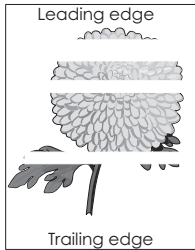

Action	Yes	No
<p>Step 1</p> <ul style="list-style-type: none"> a Make sure your software program is using a correct fill pattern. b Resend the print job. <p>Do horizontal voids appear on prints?</p>	<p>Go to step 2.</p>	<p>The problem is solved.</p>
<p>Step 2</p> <ul style="list-style-type: none"> a Load the specified tray or feeder with a recommended type of paper. b Resend the print job. <p>Do horizontal voids appear on prints?</p>	<p>Go to step 3.</p>	<p>The problem is solved.</p>
<p>Step 3</p> <ul style="list-style-type: none"> a Redistribute the toner in the imaging unit. <ul style="list-style-type: none"> 1 Remove the toner cartridge, and then the imaging unit. 2 Firmly shake the imaging unit. <p>Warning—Potential Damage: Do not expose the imaging unit to direct light for more than 10 minutes. Extended exposure to light may cause print quality problems.</p> 3 Reinstall the imaging unit, and then the cartridge. b Resend the print job. <p>Do horizontal voids appear on prints?</p>	<p>Go to step 4.</p>	<p>The problem is solved.</p>
<p>Step 4</p> <p>Replace the imaging unit, and then resend the print job.</p> <p>Do horizontal voids appear on prints?</p>	<p>Contact customer support.</p>	<p>The problem is solved.</p>

Vertical voids appear on prints

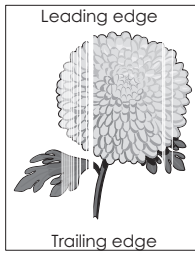

Action	Yes	No
<p>Step 1</p> <ul style="list-style-type: none"> a Make sure your software program is using a correct fill pattern. b Resend the print job. <p>Do vertical voids appear on prints?</p>	Go to step 2.	The problem is solved.
<p>Step 2</p> <ul style="list-style-type: none"> a From the printer control panel, set the paper type and weight in the Paper menu to match the paper loaded in the tray. b Resend the print job. <p>Do vertical voids appear on prints?</p>	Go to step 3.	The problem is solved.
<p>Step 3</p> <p>Check if you are using a recommended type of paper.</p> <ul style="list-style-type: none"> a Load the indicated tray or feeder with a recommended type of paper. b Resend the print job. <p>Do vertical voids appear on prints?</p>	Go to step 4.	The problem is solved.
<p>Step 4</p> <ul style="list-style-type: none"> a Redistribute the toner in the imaging unit. <ol style="list-style-type: none"> 1 Remove the toner cartridge, and then the imaging unit. 2 Firmly shake the imaging unit. <p>Warning—Potential Damage: Do not expose the imaging unit to direct light for more than 10 minutes. Extended exposure to light may cause print quality problems.</p> 3 Reinstall the imaging unit, and then the cartridge. b Resend the print job. <p>Do vertical voids appear on prints?</p>	<p>Contact customer support.</p> <p>Note: The laser scanning unit may be defective.</p>	The problem is solved.

Toner specks appear on prints

Action	Yes	No
Replace the imaging unit, and then resend the print job. Do toner specks appear on prints?	Contact customer support .	The problem is solved.

Toner rubs off

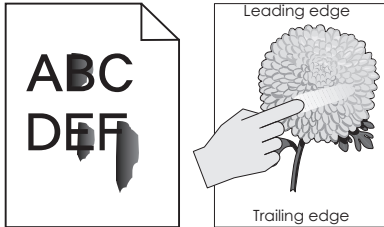

Action	Yes	No
Step 1 From the Paper menu on the printer control panel, check the paper type and weight. Do the paper type and texture match the paper loaded in the tray?	Go to step 2.	Specify the paper type and weight from the tray settings to match the paper loaded in the tray.
Step 2 Check if you are printing on paper with texture or rough finishes. Are you printing on textured or rough paper?	From the Paper menu on the printer control panel, set the paper texture.	Contact customer support .

Uneven print density

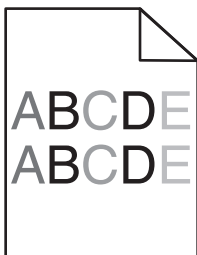

Action	Yes	No
Replace the imaging unit, and then resend the print job. Is the print density uneven?	Contact customer support .	The problem is solved.

Embedded Web Server does not open

Action	Yes	No
<p>Step 1</p> <p>a Turn on the printer.</p> <p>b Open a Web browser, and then type the printer IP address.</p> <p>c Press Enter.</p> <p>Does the Embedded Web Server open?</p>	The problem is solved.	Go to step 2.
<p>Step 2</p> <p>Make sure the printer IP address is correct.</p> <p>a View the printer IP address:</p> <ul style="list-style-type: none"> • From the TCP/IP section in the Network/Ports menu • By printing a network setup page or menu settings page, and then finding the TCP/IP section <p>Note: An IP address appears as four sets of numbers separated by periods, such as 123.123.123.123.</p> <p>b Open a Web browser, and then type the IP address.</p> <p>Note: Depending on the network settings, you may need to type “https://” instead of “http://” before the printer IP address to access the Embedded Web Server.</p> <p>c Press Enter.</p> <p>Does the Embedded Web Server open?</p>	The problem is solved.	Go to step 3.
<p>Step 3</p> <p>Check if the network is working.</p> <p>a Print a network setup page.</p> <p>b Check the first section of the network setup page and confirm that the status is Connected.</p> <p>Note: If the status is Not Connected, then the connection may be intermittent, or the network cable may be defective. Contact your system support person for a solution, and then print another network setup page.</p> <p>c Open a Web browser, and then type the printer IP address.</p> <p>d Press Enter.</p> <p>Does the Embedded Web Server open?</p>	The problem is solved.	Go to step 4.
<p>Step 4</p> <p>Check if the cable connections to the printer and print server are secure.</p> <p>a Connect the cables properly. For more information, see the setup documentation that came with the printer.</p> <p>b Open a Web browser, and then type the printer IP address.</p> <p>c Press Enter.</p> <p>Does the Embedded Web Server open?</p>	The problem is solved.	Go to step 5.

Action	Yes	No
<p>Step 5</p> <p>Temporarily disable the Web proxy servers.</p> <p>Proxy servers may block or restrict you from accessing certain Web sites including the Embedded Web Server.</p> <p>Does the Embedded Web Server open?</p>	The problem is solved.	Contact your system support person.

Contacting customer support

When you contact customer support, describe the problem you are experiencing, the message on the printer display, and the troubleshooting steps you have already taken to find a solution.

You need to know your printer model type and serial number. For more information, see the label on the inside top front cover or at the back of the printer. The serial number is also listed on the menu settings page.

Lexmark has various ways to help you solve your printing problem. Visit the Lexmark Web site at <http://support.lexmark.com>, and then select one of the following:

Tech Library	You can browse our library of manuals, support documentation, drivers, and other downloads to help you solve common problems.
E-mail	You can send an e-mail to the Lexmark team, describing your problem. A service representative will respond and provide you with information to solve your problem.
Live chat	You can chat directly with a service representative. They can work with you to solve your printer problem or provide assistance through Assisted Service where the service representative can remotely connect to your computer through the Internet to troubleshoot problems, install updates, or complete other tasks to help you successfully use your Lexmark product.

Telephone support is also available. In the U.S. or Canada, call 1-800-539-6275. For other countries or regions, visit the Lexmark Web site at <http://support.lexmark.com>.

Notices

Product information

Product name:

Lexmark MS410d, MS410dn

Machine type:

4514

Model(s):

420, 430

Edition notice

August 2012

The following paragraph does not apply to any country where such provisions are inconsistent with local law:

LEXMARK INTERNATIONAL, INC., PROVIDES THIS PUBLICATION "AS IS" WITHOUT WARRANTY OF ANY KIND, EITHER EXPRESS OR IMPLIED, INCLUDING, BUT NOT LIMITED TO, THE IMPLIED WARRANTIES OF MERCHANTABILITY OR FITNESS FOR A PARTICULAR PURPOSE. Some states do not allow disclaimer of express or implied warranties in certain transactions; therefore, this statement may not apply to you.

This publication could include technical inaccuracies or typographical errors. Changes are periodically made to the information herein; these changes will be incorporated in later editions. Improvements or changes in the products or the programs described may be made at any time.

References in this publication to products, programs, or services do not imply that the manufacturer intends to make these available in all countries in which it operates. Any reference to a product, program, or service is not intended to state or imply that only that product, program, or service may be used. Any functionally equivalent product, program, or service that does not infringe any existing intellectual property right may be used instead. Evaluation and verification of operation in conjunction with other products, programs, or services, except those expressly designated by the manufacturer, are the user's responsibility.

For Lexmark technical support, visit <http://support.lexmark.com>.

For information on supplies and downloads, visit www.lexmark.com.

If you don't have access to the Internet, you can contact Lexmark by mail:

Lexmark International, Inc.
Bldg 004-2/CSC
740 New Circle Road NW
Lexington, KY 40550
USA

© 2012 Lexmark International, Inc.

All rights reserved.

GOVERNMENT END USERS

The Software Program and any related documentation are "Commercial Items," as that term is defined in 48 C.F.R. 2.101, "Computer Software" and "Commercial Computer Software Documentation," as such terms are used in 48 C.F.R. 12.212 or 48 C.F.R. 227.7202, as applicable. Consistent with 48 C.F.R. 12.212 or 48 C.F.R. 227.7202-1 through 227.7207-4, as applicable, the Commercial Computer Software and Commercial Software Documentation are licensed to the U.S. Government end users (a) only as Commercial Items and (b) with only those rights as are granted to all other end users pursuant to the terms and conditions herein.

Trademarks

Lexmark, Lexmark with diamond design, and MarkVision are trademarks of Lexmark International, Inc., registered in the United States and/or other countries.

Mac and the Mac logo are trademarks of Apple Inc., registered in the U.S. and other countries.

PCL® is a registered trademark of the Hewlett-Packard Company. PCL is Hewlett-Packard Company's designation of a set of printer commands (language) and functions included in its printer products. This printer is intended to be compatible with the PCL language. This means the printer recognizes PCL commands used in various application programs, and that the printer emulates the functions corresponding to the commands.

All other trademarks are the property of their respective owners.

Federal Communications Commission (FCC) compliance information statement

This product has been tested and found to comply with the limits for a Class B digital device, pursuant to Part 15 of the FCC Rules. Operation is subject to the following two conditions: (1) this device may not cause harmful interference, and (2) this device must accept any interference received, including interference that may cause undesired operation.

The FCC Class B limits are designed to provide reasonable protection against harmful interference when the equipment is operated in a residential installation. This equipment generates, uses, and can radiate radio frequency energy and, if not installed and used in accordance with the instructions, may cause harmful interference to radio communications. However, there is no guarantee that interference will not occur in a particular installation. If this equipment does cause harmful interference to radio or television reception, which can be determined by turning the equipment off and on, the user is encouraged to try to correct the interference by one or more of the following measures:

- Reorient or relocate the receiving antenna.
- Increase the separation between the equipment and receiver.
- Connect the equipment into an outlet on a circuit different from that to which the receiver is connected.
- Consult your point of purchase or service representative for additional suggestions.

The manufacturer is not responsible for radio or television interference caused by using other than recommended cables or by unauthorized changes or modifications to this equipment. Unauthorized changes or modifications could void the user's authority to operate this equipment.

Note: To assure compliance with FCC regulations on electromagnetic interference for a Class B computing device, use a properly shielded and grounded cable such as Lexmark part number 1021231 for parallel attach or 1021294 for USB attach. Use of a substitute cable not properly shielded and grounded may result in a violation of FCC regulations.

Any questions regarding this compliance information statement should be directed to:

Director of Lexmark Technology & Services
Lexmark International, Inc.
740 West New Circle Road
Lexington, KY 40550
(859) 232-3000

Industry Canada compliance statement

This Class B digital apparatus meets all requirements of the Canadian Interference-Causing Equipment Standard ICES-003.

Avis de conformité aux normes de l'industrie du Canada

Cet appareil numérique de classe B est conforme aux exigences de la norme canadienne relative aux équipements pouvant causer des interférences NMB-003.

Modular component notice

This product may contain the following modular component(s):

Lexmark Regulatory Type/Model LEX-M01-005; FCC ID:IYLLEXM01005; IC:2376A-M01005

Licensing notices

All licensing notices associated with this product can be viewed from the root directory of the installation software CD.

Noise emission levels

The following measurements were made in accordance with ISO 7779 and reported in conformance with ISO 9296.

Note: Some modes may not apply to your product.

1-meter average sound pressure, dBA	
Printing	54 dBA
Ready	N/A

Values are subject to change. See www.lexmark.com for current values.

Waste from Electrical and Electronic Equipment (WEEE) directive



The WEEE logo signifies specific recycling programs and procedures for electronic products in countries of the European Union. We encourage the recycling of our products.

If you have further questions about recycling options, visit the Lexmark Web site at www.lexmark.com for your local sales office phone number.

Product disposal

Do not dispose of the printer or supplies in the same manner as normal household waste. Consult your local authorities for disposal and recycling options.

Static sensitivity notice



This symbol identifies static-sensitive parts. Do not touch in the areas near these symbols without first touching the metal frame of the printer.

ENERGY STAR

Any Lexmark product bearing the ENERGY STAR emblem on the product or on a start-up screen is certified to comply with Environmental Protection Agency (EPA) ENERGY STAR requirements as configured when shipped by Lexmark.



Temperature information

Ambient temperature	16 to 32°C (60 to 90°F)
Shipping and storage temperature	-20 to 40°C (-4 to 104°F)

Laser notice

The printer is certified in the U.S. to conform to the requirements of DHHS 21 CFR Subchapter J for Class I (1) laser products, and elsewhere is certified as a Class I laser product conforming to the requirements of IEC 60825-1.

Class I laser products are not considered to be hazardous. The printer contains internally a Class IIIb (3b) laser that is nominally a 7 milliwatt gallium arsenide laser operating in the wavelength of 655-675 nanometers. The laser system and printer are designed so there is never any human access to laser radiation above a Class I level during normal operation, user maintenance, or prescribed service condition.

Laser advisory label

A laser notice label may be affixed to this printer as shown:

DANGER - Invisible laser radiation when cartridges are removed and interlock defeated. Avoid exposure to laser beam.

PERIGO - Radiação a laser invisível será liberada se os cartuchos forem removidos e o lacre rompido. Evite a exposição aos feixes de laser.

Opasnost - Nevidljivo lasersko zračenje kada su kasete uklonjene i poništena sigurnosna veza. Izbjegavati izlaganje zracima.

NEBEZPEČÍ - Když jsou vyjmuty kazety a je odblokována pojistka, ze zařízení je vysíláno neviditelné laserové záření. Nevystavujte se působení laserového paprsku.

FARE - Usynlig laserstråling, når patroner fjernes, og spærreanordningen er slået fra. Undgå at blive udsat for laserstrålen.

GEVAAR - Onzichtbare laserstraling wanneer cartridges worden verwijderd en een vergrendeling wordt genegeerd. Voorkom blootstelling aan de laser.

DANGER - Rayonnements laser invisibles lors du retrait des cartouches et du déverrouillage des loquets. Eviter toute exposition au rayon laser.

VAARA - Näkymätöntä lasersäteilyä on varottava, kun värikasetit on poistettu ja lukitus on auki. Vältä lasersäteelle altistumista.

GEFAHR - Unsichtbare Laserstrahlung beim Herausnehmen von Druckkassetten und offener Sicherheitssperre. Laserstrahl meiden.

ΚΙΝΔΥΝΟΣ - Εκλυση αόρατης ακτινοβολίας laser κατά την αφαίρεση των κασετών και την απασφάλιση της μανδάλωσης. Αποφεύγετε την έκθεση στην ακτινοβολία laser.

VESZÉLY - Nem látható lézersugárzás fordulhat elő a patronok eltávolításakor és a zárószervezet felbontásakor. Kerülje a lézersugárnak való kitettséget.

PERICOLO - Emissione di radiazioni laser invisibili durante la rimozione delle cartucce e del blocco. Evitare l'esposizione al raggio laser.

FARE – Usynlig laserstråling når kassetene tas ut og sperren er satt ut av spill. Unngå eksponering for laserstrålen.

NIEBEZPIECZEŃSTWO - niewidzialne promieniowanie laserowe podczas usuwania kaset i blokady. Należy unikać naświetlenia promieniem lasera.

ОПАСНО! Невидимое лазерное излучение при извлеченных картриджах и снятии блокировки. Избегайте воздействия лазерных лучей.

Pozor – Nebezpečnostvo neviditeľného laserového žiarenia pri odobratých kazetách a odblokovanej poistke. Nevystavujte sa lúčom.

PELIGRO: Se producen radiaciones láser invisibles al extraer los cartuchos con el interbloqueo desactivado. Evite la exposición al haz de láser.

FARA – Osynlig laserstrålning när patroner tas ur och spärrmekanismen är upphävd. Undvik exponering för laserstrålen.

危険 - 当移除碳粉盒及互锁失效时会产生看不见的激光辐射, 请避免暴露在激光光束下。

危険 - 移除碳粉匣與安全連續開關失效時會產生看不見的雷射輻射。請避免暴露在雷射光束下。

危険 - カートリッジが取り外され、内部ロックが無効になると、見えないレーザー光が放射されます。このレーザー光に当たらないようにしてください。

Power consumption

Product power consumption

The following table documents the power consumption characteristics of the product.

Note: Some modes may not apply to your product.

Mode	Description	Power consumption (Watts)
Printing	The product is generating hard-copy output from electronic inputs.	560 W
Copy	The product is generating hard-copy output from hard-copy original documents.	NA
Scan	The product is scanning hard-copy documents.	NA
Ready	The product is waiting for a print job.	8 W
Sleep Mode	The product is in a high-level energy-saving mode.	5 W
Hibernate	The product is in a low-level energy-saving mode.	1.0 W
Off	The product is plugged into an electrical outlet, but the power switch is turned off.	0.0 W

The power consumption levels listed in the previous table represent time-averaged measurements. Instantaneous power draws may be substantially higher than the average.

Values are subject to change. See www.lexmark.com for current values.

Sleep Mode

This product is designed with an energy-saving mode called *Sleep Mode*. The Sleep Mode saves energy by lowering power consumption during extended periods of inactivity. The Sleep Mode is automatically engaged after this product is not used for a specified period of time, called the *Sleep Mode Timeout*.

Factory default Sleep Mode Timeout for this product (in minutes):	30
---	----

By using the configuration menus, the Sleep Mode Timeout can be modified between 1 minute and 120 minutes. Setting the Sleep Mode Timeout to a low value reduces energy consumption, but may increase the response time of the product. Setting the Sleep Mode Timeout to a high value maintains a fast response, but uses more energy.

Hibernate Mode

This product is designed with an ultra-low power operating mode called *Hibernate mode*. When operating in Hibernate Mode, all other systems and devices are powered down safely.

The Hibernate mode can be entered in any of the following methods:

- Using the Hibernate Timeout
- Using the Schedule Power modes
- Using the Sleep/Hibernate button

Factory default Hibernate Timeout for this product in all countries or regions except for EU countries and Switzerland	Disabled
Factory default value for this product in EU countries or regions and Switzerland	3 days

The amount of time the printer waits after a job is printed before it enters Hibernate mode can be modified between one hour and one month.

Off mode

If this product has an off mode which still consumes a small amount of power, then to completely stop product power consumption, disconnect the power supply cord from the electrical outlet.

Total energy usage

It is sometimes helpful to calculate the total product energy usage. Since power consumption claims are provided in power units of Watts, the power consumption should be multiplied by the time the product spends in each mode in order to calculate energy usage. The total product energy usage is the sum of each mode's energy usage.

European Community (EC) directives conformity

This product is in conformity with the protection requirements of EC Council directives 2004/108/EC, 2006/95/EC and 2009/125/EC on the approximation and harmonization of the laws of the Member States relating to electromagnetic compatibility, safety of electrical equipment designed for use within certain voltage limits and the ecodesign of energy-related products.

The manufacturer of this product is: Lexmark International, Inc., 740 West New Circle Road, Lexington, KY, 40550 USA. The authorized representative is: Lexmark International Technology Hungária Kft., 8 Lechner Ödön fasor, Millennium Tower III, 1095 Budapest HUNGARY, A declaration of conformity to the requirements of the Directives is available upon request from the Authorized Representative.

This product satisfies the Class B limits of EN 55022 and safety requirements of EN 60950.

Regulatory notices for wireless products

This section contains the following regulatory information pertaining to wireless products that contain transmitters, for example, but not limited to, wireless network cards or proximity card readers.

Exposure to radio frequency radiation

The radiated output power of this device is far below the radio frequency exposure limits of the FCC and other regulatory agencies. A minimum separation of 20 cm (8 inches) must be maintained between the antenna and any persons for this device to satisfy the RF exposure requirements of the FCC and other regulatory agencies.

Industry Canada (Canada)

This device complies with Industry Canada specification RSS-210. Operation is subject to the following two conditions: (1) this device may not cause interference, and (2) this device must accept any interference, including interference that may cause undesired operation of the device.

This device has been designed to operate only with the antenna provided. Use of any other antenna is strictly prohibited per regulations of Industry Canada.

To prevent radio interference to the licensed service, this device is intended to be operated indoors and away from windows to provide maximum shielding. Equipment (or its transmit antenna) that is installed outdoors is subject to licensing.

The installer of this radio equipment must ensure that the antenna is located or pointed such that it does not emit RF fields in excess of Health Canada limits for the general population; consult Safety Code 6, obtainable from Health Canada's Web site www.hc-sc.gc.ca/rpb.

The term "IC:" before the certification/registration number only signifies that the Industry Canada technical specifications were met.

Industry Canada (Canada)

Cet appareil est conforme à la norme RSS-210 d'Industry Canada. Son fonctionnement est soumis aux deux conditions suivantes :

(1) cet appareil ne doit pas provoquer d'interférences et (2) il doit accepter toute interférence reçue, y compris celles risquant d'altérer son fonctionnement.

Cet appareil a été conçu pour fonctionner uniquement avec l'antenne fournie. L'utilisation de toute autre antenne est strictement interdite par la réglementation d'Industry Canada.

En application des réglementations d'Industry Canada, l'utilisation d'une antenne de gain supérieur est strictement interdite.

Pour empêcher toute interférence radio au service faisant l'objet d'une licence, cet appareil doit être utilisé à l'intérieur et loin des fenêtres afin de garantir une protection optimale.

Si le matériel (ou son antenne d'émission) est installé à l'extérieur, il doit faire l'objet d'une licence.

L'installateur de cet équipement radio doit veiller à ce que l'antenne soit implantée et dirigée de manière à n'émettre aucun champ HF dépassant les limites fixées pour l'ensemble de la population par Santé Canada. Reportez-vous au Code de sécurité 6 que vous pouvez consulter sur le site Web de Santé Canada www.hc-sc.gc.ca/rpb.

Le terme « IC » précédant le numéro de d'accréditation/inscription signifie simplement que le produit est conforme aux spécifications techniques d'Industry Canada.

Notice to users in the European Union

This product is in conformity with the protection requirements of EC Council directives 2004/108/EC, 2006/95/EC, 1999/5/EC, and 2009/125/EC on the approximation and harmonization of the laws of the Member States relating to electromagnetic compatibility, safety of electrical equipment designed for use within certain voltage limits, radio equipment and telecommunications terminal equipment and on the ecodesign of energy-related products.

Compliance is indicated by the CE marking.



The manufacturer of this product is: Lexmark International, Inc., 740 West New Circle Road, Lexington, KY, 40550 USA. The authorized representative is: Lexmark International Technology Hungária Kft., 8 Lechner Ödön fasor, Millennium Tower III, 1095 Budapest HUNGARY, A declaration of conformity to the requirements of the Directives is available upon request from the Authorized Representative.

This product satisfies the Class B limits of EN 55022 and safety requirements of EN 60950.

Products equipped with 2.4GHz Wireless LAN option are in conformity with the protection requirements of EC Council directives 2004/108/EC, 2006/95/EC, 1999/5/EC, and 2009/125/EC on the approximation and harmonization of the laws of the Member States relating to electromagnetic compatibility, safety of electrical equipment designed for use

within certain voltage limits and on radio equipment and telecommunications terminal equipment and on the ecodesign of energy-related products.

Compliance is indicated by the CE marking.



Operation is allowed in all EU and EFTA countries, but is restricted to indoor use only.

The manufacturer of this product is: Lexmark International, Inc., 740 West New Circle Road, Lexington, KY, 40550 USA. The authorized representative is: Lexmark International Technology Hungária Kft., 8 Lechner Ödön fasor, Millennium Tower III, 1095 Budapest HUNGARY, A declaration of conformity to the requirements of the Directives is available upon request from the Authorized Representative.

This product may be used in the countries indicated in the table below.

AT	BE	BG	CH	CY	CZ	DE	DK	EE
EL	ES	FI	FR	HR	HU	IE	IS	IT
LI	LT	LU	LV	MT	NL	NO	PL	PT
RO	SE	SI	SK	TR	UK			

Česky	Společnost Lexmark International, Inc. tímto prohlašuje, že výrobek tento výrobek je ve shodě se základními požadavky a dalšími příslušnými ustanoveními směrnice 1999/5/ES.
Dansk	Lexmark International, Inc. erklærer herved, at dette produkt overholder de væsentlige krav og øvrige relevante krav i direktiv 1999/5/EF.
Deutsch	Hiermit erklärt Lexmark International, Inc., dass sich das Gerät dieses Gerät in Übereinstimmung mit den grundlegenden Anforderungen und den übrigen einschlägigen Bestimmungen der Richtlinie 1999/5/EG befindet.
Ελληνική	ΜΕ ΤΗΝ ΠΑΡΟΥΣΑ Η LEXMARK INTERNATIONAL, INC. ΔΗΛΩΝΕΙ ΟΤΙ ΑΥΤΟ ΤΟ ΠΡΟΪΟΝ ΣΥΜΜΟΡΦΩΝΕΤΑΙ ΠΡΟΣ ΤΙΣ ΟΥΣΙΩΔΕΙΣ ΑΠΑΙΤΗΣΕΙΣ ΚΑΙ ΤΙΣ ΛΟΙΠΕΣ ΣΧΕΤΙΚΕΣ ΔΙΑΤΑΞΕΙΣ ΤΗΣ ΟΔΗΓΙΑΣ 1999/5/ΕΚ.
English	Hereby, Lexmark International, Inc., declares that this type of equipment is in compliance with the essential requirements and other relevant provisions of Directive 1999/5/EC.
Español	Por medio de la presente, Lexmark International, Inc. declara que este producto cumple con los requisitos esenciales y cualesquiera otras disposiciones aplicables o exigibles de la Directiva 1999/5/CE.
Eesti	Käesolevaga kinnitab Lexmark International, Inc., et seade see toode vastab direktiivi 1999/5/EÜ põhinõuetele ja nimetatud direktiivist tulenevatele muudele asjakohastele sätetele.
Suomi	Lexmark International, Inc. vakuuttaa täten, että tämä tuote on direktiivin 1999/5/EY oleellisten vaatimusten ja muiden sitä koskevien direktiivin ehtojen mukainen.
Français	Par la présente, Lexmark International, Inc. déclare que l'appareil ce produit est conforme aux exigences fondamentales et autres dispositions pertinentes de la directive 1999/5/CE.
Magyar	Alulírott, Lexmark International, Inc. nyilatkozom, hogy a termék megfelel a vonatkozó alapvető követelményeknek és az 1999/5/EC irányelv egyéb előírásainak.
Íslenska	Hér með lýsir Lexmark International, Inc. yfir því að þessi vara er í samræmi við grunnkröfur og aðrar kröfur, sem gerðar eru í tilskipun 1999/5/EC.

Italiano	Con la presente Lexmark International, Inc. dichiara che questo prodotto è conforme ai requisiti essenziali ed alle altre disposizioni pertinenti stabilite dalla direttiva 1999/5/CE.
Latviski	Ar šo Lexmark International, Inc. deklarē, ka šis izstrādājums atbilst Direktīvas 1999/5/EK būtiskajām prasībām un citiem ar to saistītajiem noteikumiem.
Lietuvių	Šiuo Lexmark International, Inc. deklaruoja, kad šis produktas atitinka esminius reikalavimus ir kitas 1999/5/EB direktyvos nuostatas.
Malti	Bil-preżenti, Lexmark International, Inc., jiddikjara li dan il-prodott huwa konformi mal-ħtiġijiet essenzjali u ma dispożizzjonijiet oħrajn relevanti li jinsabu fid-Direttiva 1999/5/KE.
Nederlands	Hierbij verklaart Lexmark International, Inc. dat het toestel dit product in overeenstemming is met de essentiële eisen en de andere relevante bepalingen van richtlijn 1999/5/EG.
Norsk	Lexmark International, Inc. erklærer herved at dette produktet er i samsvar med de grunnleggende krav og øvrige relevante krav i direktiv 1999/5/EF.
Polski	Niniejszym Lexmark International, Inc. oświadcza, że niniejszy produkt jest zgodny z zasadniczymi wymogami oraz pozostałymi stosownymi postanowieniami Dyrektywy 1999/5/EC.
Português	A Lexmark International Inc. declara que este produto está conforme com os requisitos essenciais e outras disposições da Diretiva 1999/5/CE.
Slovensky	Lexmark International, Inc. týmto vyhlasuje, že tento produkt spĺňa základné požiadavky a všetky príslušné ustanovenia smernice 1999/5/ES.
Slovensko	Lexmark International, Inc. izjavlja, da je ta izdelek v skladu z bistvenimi zahtevami in ostalimi relevantnimi določili direktive 1999/5/ES.
Svenska	Härmed intygar Lexmark International, Inc. att denna produkt står i överensstämmelse med de väsentliga egenskapskrav och övriga relevanta bestämmelser som framgår av direktiv 1999/5/EG.

Patent acknowledgment

The use of this product or service is subject to the reasonable, non-discriminatory terms in the Intellectual Property Rights (IPR) Disclosure of Certicom Corp. at the IETF for Elliptic Curve Cryptography (ECC) Cipher Suites for Transport Layer Security (TLS) implemented in the product or service.

The use of this product or service is subject to the reasonable, non-discriminatory terms in the Intellectual Property Rights (IPR) Disclosure of Certicom Corp. at the IETF for TLS Elliptic Curve Cipher Suites with SHA-256/382 and AES Galois Counter Mode (GCM) implemented in the product or service.

The use of this product or service is subject to the reasonable, non-discriminatory terms in the Intellectual Property Rights (IPR) Disclosure of Certicom Corp. at the IETF for TLS Suite B Profile for Transport Layer Security (TLS) implemented in the product or service.

The use of this product or service is subject to the reasonable, non-discriminatory terms in the Intellectual Property Rights (IPR) Disclosure of Certicom Corp. at the IETF for Addition of the Camellia Cipher Suites to Transport Layer Security (TLS) implemented in the product or service.

The use of certain patents in this product or service is subject to the reasonable, non-discriminatory terms in the Intellectual Property Rights (IPR) Disclosure of Certicom Corp. at the IETF for AES-CCM ECC Cipher Suites for TLS implemented in the product or service.

The use of this product or service is subject to the reasonable, non-discriminatory terms in the Intellectual Property Rights (IPR) Disclosure of Certicom Corp. at the IETF for IKE and IKEv2 Authentication Using the Elliptic Curve Digital Signature Algorithm (ECDSA) implemented in the product or service.

The use of this product or service is subject to the reasonable, non-discriminatory terms in the Intellectual Property Rights (IPR) Disclosure of Certicom Corp. at the IETF for Suite B Cryptographic Suites for IPsec implemented in the product or service.

The use of this product or service is subject to the reasonable, non-discriminatory terms in the Intellectual Property Rights (IPR) Disclosure of Certicom Corp. at the IETF for Algorithms for Internet Key Exchange version 1 (IKEv1) implemented in the product or service.

STATEMENT OF LIMITED WARRANTY FOR LEXMARK LASER PRINTERS, LEXMARK LED PRINTERS, AND LEXMARK MULTIFUNCTION LASER PRINTERS

Lexmark International, Inc., Lexington, KY

This limited warranty applies to the United States and Canada. For customers outside the U.S., refer to the country-specific warranty information that came with your product.

This limited warranty applies to this product only if it was originally purchased for your use, and not for resale, from Lexmark or a Lexmark Remarketer, referred to in this statement as "Remarketer."

Limited warranty

Lexmark warrants that this product:

- Is manufactured from new parts, or new and serviceable used parts, which perform like new parts
- Is, during normal use, free from defects in material and workmanship

If this product does not function as warranted during the warranty period, contact a Remarketer or Lexmark for repair or replacement (at Lexmark's option).

If this product is a feature or option, this statement applies only when that feature or option is used with the product for which it was intended. To obtain warranty service, you may be required to present the feature or option with the product.

If you transfer this product to another user, warranty service under the terms of this statement is available to that user for the remainder of the warranty period. You should transfer proof of original purchase and this statement to that user.

Limited warranty service

The warranty period starts on the date of original purchase as shown on the purchase receipt and ends 12 months later provided that the warranty period for any supplies and for any maintenance items included with the printer shall end earlier if it, or its original contents, are substantially used up, depleted, or consumed. Fuser Units, Transfer/Transport Units, Paper Feed items, if any, and any other items for which a Maintenance Kit is available are substantially consumed when the printer displays a "Life Warning" or "Scheduled Maintenance" message for such item.

To obtain warranty service you may be required to present proof of original purchase. You may be required to deliver your product to the Remarketer or Lexmark, or ship it prepaid and suitably packaged to a Lexmark designated location. You are responsible for loss of, or damage to, a product in transit to the Remarketer or the Lexmark designated location.

When warranty service involves the exchange of a product or part, the item replaced becomes the property of the Remarketer or Lexmark. The replacement may be a new or repaired item.

The replacement item assumes the remaining warranty period of the original product.

Replacement is not available to you if the product you present for exchange is defaced, altered, in need of a repair not included in warranty service, damaged beyond repair, or if the product is not free of all legal obligations, restrictions, liens, and encumbrances.

As part of your warranty service and/or replacement, Lexmark may update the firmware in your printer to the latest version. Firmware updates may modify printer settings and cause counterfeit and/or unauthorized products, supplies, parts, materials (such as toners and inks), software, or interfaces to stop working. Authorized use of genuine Lexmark products will not be impacted.

Before you present this product for warranty service, remove all print cartridges, programs, data, and removable storage media (unless directed otherwise by Lexmark).

For further explanation of your warranty alternatives and the nearest Lexmark authorized servicer in your area contact Lexmark on the World Wide Web.

Remote technical support is provided for this product throughout its warranty period. For products no longer covered by a Lexmark warranty, technical support may not be available or only be available for a fee.

Extent of limited warranty

Lexmark does not warrant uninterrupted or error-free operation of any product or the durability or longevity of prints produced by any product.

Warranty service does not include repair of failures caused by:

- Modification or unauthorized attachments
- Accidents, misuse, abuse or use inconsistent with Lexmark user's guides, manuals, instructions or guidance
- Unsuitable physical or operating environment
- Maintenance by anyone other than Lexmark or a Lexmark authorized servicer
- Operation of a product beyond the limit of its duty cycle
- Use of printing media outside of Lexmark specifications
- Refurbishment, repair, refilling or remanufacture by a third party of products, supplies or parts
- Products, supplies, parts, materials (such as toners and inks), software, or interfaces not furnished by Lexmark

TO THE EXTENT PERMITTED BY APPLICABLE LAW, NEITHER LEXMARK NOR ITS THIRD PARTY SUPPLIERS OR REMARKETERS MAKE ANY OTHER WARRANTY OR CONDITION OF ANY KIND, WHETHER EXPRESS OR IMPLIED, WITH RESPECT TO THIS PRODUCT, AND SPECIFICALLY DISCLAIM THE IMPLIED WARRANTIES OR CONDITIONS OF MERCHANTABILITY, FITNESS FOR A PARTICULAR PURPOSE, AND SATISFACTORY QUALITY. ANY WARRANTIES THAT MAY NOT BE DISCLAIMED UNDER APPLICABLE LAW ARE LIMITED IN DURATION TO THE WARRANTY PERIOD. NO WARRANTIES, EXPRESS OR IMPLIED, WILL APPLY AFTER THIS PERIOD. ALL INFORMATION, SPECIFICATIONS, PRICES, AND SERVICES ARE SUBJECT TO CHANGE AT ANY TIME WITHOUT NOTICE.

Limitation of liability

Your sole remedy under this limited warranty is set forth in this document. For any claim concerning performance or nonperformance of Lexmark or a Remarketer for this product under this limited warranty, you may recover actual damages up to the limit set forth in the following paragraph.

Lexmark's liability for actual damages from any cause whatsoever will be limited to the amount you paid for the product that caused the damages. This limitation of liability will not apply to claims by you for bodily injury or damage to real property or tangible personal property for which Lexmark is legally liable. **IN NO EVENT WILL LEXMARK BE LIABLE FOR ANY LOST PROFITS, LOST SAVINGS, INCIDENTAL DAMAGE, OR OTHER ECONOMIC OR CONSEQUENTIAL DAMAGES.**

This is true even if you advise Lexmark or a Remarketer of the possibility of such damages. Lexmark is not liable for any claim by you based on a third party claim.

This limitation of remedies also applies to claims against any Suppliers and Remarketers of Lexmark. Lexmark's and its Suppliers' and Remarketers' limitations of remedies are not cumulative. Such Suppliers and Remarketers are intended beneficiaries of this limitation.

Additional rights

Some states do not allow limitations on how long an implied warranty lasts, or do not allow the exclusion or limitation of incidental or consequential damages, so the limitations or exclusions contained above may not apply to you.

This limited warranty gives you specific legal rights. You may also have other rights that vary from state to state.

Index

A

accessing the controller board 14
 Active NIC menu 63
 adjusting Sleep mode 85
 adjusting toner darkness 50
 administrator settings
 Embedded Web Server 99
 AppleTalk menu 67
 assigning custom paper types 41
 attaching cables 20
 available internal options 14
 avoiding jams 46
 avoiding paper jams 103

B

Bin full. Remove paper. 122

C

cables
 Ethernet 20
 parallel 20
 USB 20
 canceling
 print job, from computer 52
 canceling a print job
 from a computer 52
 from the printer control panel 51
 Cannot collate large document
 [37] 117
 Cannot defrag flash memory
 [37] 117
 cannot open Embedded Web
 Server 151
 card stock
 loading, multipurpose feeder 36
 tips 44
 Cartridge low [88.xy] 114
 Cartridge nearly low [88.xy] 114
 Cartridge very low, [x] estimated
 pages remain [88.xy] 114
 Cartridge, imaging unit mismatch
 [41.xy] 114
 Change [paper source] to [custom
 string]. Load [orientation]. 115
 Change [paper source] to [custom
 type name]. Load [orientation]. 115

Change [paper source] to [paper
 size]. Load [orientation]. 115
 Change [paper source] to [paper
 type] [paper size]. Load
 [orientation]. 115
 checking an unresponsive
 printer 123
 checking the status of parts and
 supplies 90
 checking the virtual display
 using the Embedded Web
 Server 99
 cleaning
 exterior of the printer 90
 cleaning the printer 90
 Close front door 115
 confidential data
 information on securing 89
 confidential jobs
 modifying print settings 100
 configuration information
 wireless network 25
 configurations
 printer 9
 Configure MP menu 57
 configuring
 multiple printers 101
 supply notifications, imaging
 unit 99
 supply notifications, toner
 cartridge 99
 configuring custom paper types 40
 configuring supply notifications 99
 connecting to a wireless network
 using Personal Identification
 Number (PIN) method 26
 using Push Button Configuration
 (PBC) method 26
 using the Embedded Web
 Server 28
 conservation settings
 conserving supplies 83
 Eco-Mode 84
 Hibernate mode 84
 Hibernate Timeout 86
 Schedule Power Modes 86
 Sleep mode 85
 conserving supplies 83

contacting customer support 152
 control panel, printer
 buttons 11
 indicator light 11, 12
 Sleep button light 12
 using 11
 controller board
 accessing 14
 creating the printer control panel
 PIN 101
 Custom Name [x] name
 configuring 40
 custom paper type
 assigning 41
 configuring 40
 custom paper type name
 configuring 40
 Custom Types menu 61

D

Default Source menu 53
 Defective flash memory [51] 116
 display troubleshooting
 printer display is blank 125
 documents, printing
 from Macintosh 50
 from Windows 50

E

Eco-Mode setting 84
 Embedded Web Server
 accessing 12
 administrator settings 99
 copying settings to other
 printers 101
 functions 12
 modifying confidential print
 settings 100
 networking settings 99
 problem accessing 151
 using 12
 Embedded Web Server
 Administrator's Guide
 where to find 89, 99
 emission notices 154, 155, 159, 160
 envelopes
 loading, multipurpose feeder 36
 tips on using 45

- environmental settings
 - conserving supplies 83
 - Eco-Mode 84
 - Hibernate mode 84
 - Hibernate Timeout 86
 - Schedule Power Modes 86
 - Sleep mode 85
- erasing non-volatile memory 89
- erasing volatile memory 89
- Ethernet network
 - preparing to set up for Ethernet printing 23
- Ethernet network setup
 - using Macintosh 24
 - using Windows 24
- Ethernet networking
 - Macintosh 24
 - Windows 24
- Ethernet port 20
- Ethernet setup
 - preparing for an 23
- exterior of the printer
 - cleaning 90

F

- factory defaults, restoring 101
- FCC notices 154, 159
- finding more information about the printer 7
- Finishing menu 77
- Flash memory full [52] 120
- Flash memory unformatted [53] 123
- font sample list, printing 51

G

- General Settings menu 72
- green settings
 - Eco-Mode 84
 - Hibernate mode 84
 - Hibernate Timeout 86
 - Schedule Power Modes 86

H

- Hibernate mode
 - using 84
- Hibernate Timeout
 - setting 86

I

- imaging unit
 - ordering 93
 - replacing 95
- Imaging unit low [84.xy] 115
- Imaging unit nearly low [84.xy] 114
- Imaging unit very low, [x] estimated pages remain [84.xy] 114
- Insert tray [x] 116
- installing
 - optional tray 19
- installing an optional card 17
- installing optional tray 19
- installing printer on a network
 - Ethernet networking 24
- installing printer software 21
 - adding options 22
- installing software
 - Local Printer Settings Utility 22
- IPv6 menu 66

J

- Jam, front door [20y.xx] 106
- Jam, MP feeder [250.xx] 113
- Jam, pull tray 1. Push down blue flap. [23y.xx] 111
- Jam, rear door [20y.xx] 109
- Jam, standard bin [20y.xx] 110
- Jam, tray [x] [24y.xx] 112
- jams
 - accessing 104
 - avoiding 103
 - understanding messages 104
- jams, clearing
 - behind front door 106
 - behind rear door 109
 - in duplex area 111
 - in standard bin 110
 - in Tray 1 112
 - in Tray 2 112
 - Multipurpose feeder 113

L

- labels, paper
 - tips 45
- letterhead
 - loading, multipurpose feeder 36
 - tips on using 46
- linking trays 39
- Load [paper source] with [custom string] [orientation] 117

- Load [paper source] with [custom type name] [orientation] 117
- Load [paper source] with [paper size] [orientation] 118
- Load [paper source] with [paper type] [paper size] [orientation] 118
- Load MP feeder with [custom string] [orientation] 118
- Load MP feeder with [custom type name] [orientation] 118
- Load MP feeder with [paper size] [orientation] 119
- Load MP feeder with [paper type] [paper size] [orientation] 119
- loading
 - multipurpose feeder 36
 - trays 31
- loading the optional tray 31
- loading the standard tray 31
- Local Printer Settings Utility
 - installing 22
 - using 13
- lock, security 88

M

- May misprint complex page [39] 116
- memory
 - types installed on printer 88
- memory card
 - installing 15
 - troubleshooting 127
- Memory full [38] 119
- Memory low, no Resource Save [35] 116
- menu settings
 - loading on multiple printers 101
- menu settings page
 - printing 28
- menus
 - Active NIC 63
 - AppleTalk 67
 - Configure MP 57
 - Custom Types 61
 - Default Source 53
 - Finishing 77
 - General Settings 72
 - in Local Printer Settings Utility 13
 - IPv6 66
 - list of 53
 - Network [x] 63
 - Network Card 65

- Network Reports 64
- Paper Loading 60
- Paper Size/Type 54
- Paper Texture 57
- Paper Weight 59
- PCL Emul 80
- PostScript 80
- Quality 78
- Reports 62
- Security Audit Log 70
- Set Date and Time 71
- Setup 75
- SMTP Setup menu 69
- Standard Network 63
- Standard USB 68
- Substitute Size 57
- TCP/IP 65
- Universal Setup 62
- Utilities 79
- Wireless 67
- XPS 80
- menus list 53
- moving the printer 8, 97, 98
- multipurpose feeder
 - loading 36

N

- Network [x] menu 63
- Network Card menu 65
- Network error, port [x] [54] 120
- Network error, standard port [54] 122
- Network Reports menu 64
- network settings
 - Embedded Web Server 99
- network setup page
 - printing 29
- Networking Guide
 - where to find 99
- noise emission levels 155
- Non-Lexmark [supply type], see User's Guide [33.xy] 119
- non-volatile memory 88
 - erasing 89
- notices 154, 155, 156, 157, 158, 159, 160, 161
- number of remaining pages
 - estimate 91

O

- optional card
 - installing 17
- optional tray
 - installing 19
 - loading 31
- options
 - memory card 15
 - memory cards 14
 - updating in printer driver 22
- ordering
 - imaging unit 93
- ordering supplies
 - toner cartridges 91

P

- paper
 - characteristics 42
 - letterhead 43
 - loading, multipurpose feeder 36
 - preprinted forms 43
 - recycled 44, 83
 - selecting 43
 - storing 46
 - unacceptable 43
 - Universal size setting 30
- paper feed troubleshooting
 - message remains after jam is cleared 128
- paper jams
 - avoiding 103
- paper jams, clearing
 - behind front door 106
 - behind rear door 109
 - in duplex area 111
 - in standard bin 110
 - in Tray 1 112
 - in Tray 2 112
 - Multipurpose feeder 113
- paper labels
 - loading, multipurpose feeder 36
- Paper Loading menu 60
- paper messages
 - Jam, pull tray 1. Push down blue flap. [23y.xx] 111
- paper size
 - setting 30
- Paper Size/Type menu 54
- paper sizes
 - supported by the printer 47
- paper stop, using 31
- Paper Texture menu 57
- Paper too short [34] 116
- paper type
 - setting 30
- paper types
 - duplex support 48
 - supported by printer 48
 - where to load 48
- Paper Weight menu 59
- parallel port 20
- Parallel port disabled [56] 122
- parts
 - checking status 90
 - using genuine Lexmark 91
- PCL Emul menu 80
- Personal Identification Number method
 - using 26
- PostScript menu 80
- preparing to set up the printer on an Ethernet network 23
- print irregularities 140
- print job
 - canceling from the printer control panel 51
 - canceling, from computer 52
- print quality troubleshooting
 - blank pages 134
 - characters have jagged edges 134
 - clipped pages or images 135
 - gray background on prints 137
 - horizontal voids appear on prints 148
 - print irregularities 140
 - print is too dark 141
 - print is too light 143
 - printer is printing solid black pages 145
 - repeating print defects appear on prints 141
 - shadow images appear on prints 136
 - skewed print 144
 - streaked horizontal lines appear on prints 146
 - streaked vertical lines 147
 - toner rubs off 150
 - toner specks appear on prints 150
 - transparency print quality is poor 145
 - uneven print density 150
 - white streaks 149

- print troubleshooting
 - incorrect characters print 132
 - incorrect margins on prints 138
 - jammed pages are not reprinted 129
 - job prints from wrong tray 131
 - job prints on wrong paper 131
 - jobs do not print 129
 - Large jobs do not collate 133
 - paper curl 139
 - paper frequently jams 128
 - print job takes longer than expected 131
 - printing slows down 130
 - tray linking does not work 132
 - unexpected page breaks occur 133
 - printer
 - configurations 9
 - minimum clearances 8
 - moving 8, 97, 98
 - selecting a location 8
 - shipping 98
 - printer configurations
 - basic model 9
 - configured model 9
 - printer control panel
 - buttons 11
 - factory defaults, restoring 101
 - indicator light 11, 12
 - Sleep button light 12
 - using 11
 - printer control panel PIN
 - creating 101
 - printer control panel, virtual display
 - using the Embedded Web Server 99
 - printer information
 - where to find 7
 - printer is printing blank pages 134
 - printer messages
 - Bin full. Remove paper. 122
 - Cannot collate large document [37] 117
 - Cannot defrag flash memory [37] 117
 - Cartridge low [88.xy] 114
 - Cartridge nearly low [88.xy] 114
 - Cartridge very low, [x] estimated pages remain [88.xy] 114
 - Cartridge, imaging unit mismatch [41.xy] 114
 - Change [paper source] to [custom string]. Load [orientation]. 115
 - Change [paper source] to [custom type name]. Load [orientation]. 115
 - Change [paper source] to [paper size]. Load [orientation]. 115
 - Change [paper source] to [paper type] [paper size]. Load [orientation]. 115
 - Close front door 115
 - Defective flash memory [51] 116
 - Flash memory full [52] 120
 - Flash memory unformatted [53] 123
 - Imaging unit low [84.xy] 115
 - Imaging unit nearly low [84.xy] 114
 - Imaging unit very low, [x] estimated pages remain [84.xy] 114
 - Insert tray [x] 116
 - Jam, front door [20y.xx] 106
 - Jam, MP feeder [250.xx] 113
 - Jam, rear door [20y.xx] 109
 - Jam, standard bin [20y.xx] 110
 - Jam, tray [x] [24y.xx] 112
 - Load [paper source] with [custom string] [orientation] 117
 - Load [paper source] with [custom type name] [orientation] 117
 - Load [paper source] with [paper size] [orientation] 118
 - Load [paper source] with [paper type] [paper size] [orientation] 118
 - Load MP feeder with [custom string] [orientation] 118
 - Load MP feeder with [custom type name] [orientation] 118
 - Load MP feeder with [paper size] [orientation] 119
 - Load MP feeder with [paper type] [paper size] [orientation] 119
 - May misprint complex page [39] 116
 - Memory full [38] 119
 - Memory low, no Resource Save [35] 116
 - Network error, port [x] [54] 120
 - Network error, standard port [54] 122
 - Non-Lexmark [supply type], see User's Guide [33.xy] 119
 - Paper too short [34] 116
 - Parallel port disabled [56] 122
 - Printer restart. Check last job. 120
 - Rear USB port disabled [56] 122
 - Reinstall missing or unresponsive cartridge [31.xy] 121
 - Reinstall missing or unresponsive imaging unit [31.xy] 121
 - Replace cartridge, 0 estimated pages remain [88.xy] 120
 - Replace cartridge, printer region mismatch [42.xy] 120
 - Replace imaging unit, 0 estimated pages remain [84.xy] 121
 - Replace unsupported cartridge [32.xy] 122
 - Replace unsupported imaging unit [32.xy] 122
 - Too many trays. Remove some. [58] 123
 - printer options troubleshooting
 - internal option is not detected 125
 - memory card 127
 - tray problems 126
 - printer problems, solving basic 123
 - Printer restart. Check last job. 120
 - printer security
 - information on 89
 - printer software
 - installing 21
 - printing
 - font sample list 51
 - from Macintosh 50
 - from Windows 50
 - menu settings page 28
 - network setup page 29
 - printing a document 50
 - publications
 - where to find 7
 - Push Button Configuration method using 26
- ## Q
- Quality menu 78

R

Rear USB port disabled [56] 122
 recycled paper
 using 44, 83
 recycling
 Lexmark packaging 87
 Lexmark products 87
 toner cartridges 87
 Reinstall missing or unresponsive cartridge [31.xy] 121
 Reinstall missing or unresponsive imaging unit [31.xy] 121
 repeating print defects appear on prints 141
 Replace cartridge, 0 estimated pages remain [88.xy] 120
 Replace cartridge, printer region mismatch [42.xy] 120
 Replace imaging unit, 0 estimated pages remain [84.xy] 121
 Replace unsupported cartridge [32.xy] 122
 Replace unsupported imaging unit [32.xy] 122
 replacing
 imaging unit 95
 toner cartridge 94
 reports
 viewing 99
 Reports menu 62
 restoring factory default settings 101

S

safety information 5, 6
 Schedule Power Modes
 using 86
 security
 modifying confidential print settings 100
 Security Audit Log menu 70
 security lock 88
 security Web page
 where to find 89
 selecting a location for the printer 8
 selecting paper 43
 Set Date and Time menu 71
 setting
 paper size 30
 paper type 30

TCP/IP address 65
 Universal paper size 30
 setting Hibernate Timeout 86
 setting up the printer
 on an Ethernet network (Macintosh only) 24
 on an Ethernet network (Windows only) 24
 Setup menu 75
 shipping the printer 98
 Sleep mode
 adjusting 85
 SMTP Setup menu 69
 standard bin, using 31
 Standard Network menu 63
 standard tray
 loading 31
 Standard USB menu 68
 statement of volatility 88
 storing
 paper 46
 supplies 93
 streaked horizontal lines appear on prints 146
 streaked vertical lines appear on prints 147
 streaks appear 149
 Substitute Size menu 57
 supplies
 checking status 90
 conserving 83
 storing 93
 using genuine Lexmark 91
 using recycled paper 83
 supplies, ordering
 imaging unit 93
 toner cartridges 91
 supply notifications
 configuring 99
 supported paper sizes 47
 supported paper types and weights 48

T

TCP/IP menu 65
 tips
 card stock 44
 labels, paper 45
 letterhead 46
 on using envelopes 45
 transparencies 46
 tips on using envelopes 45

toner cartridge
 replacing 94
 toner cartridges
 ordering 91
 recycling 87
 toner darkness
 adjusting 50
 Too many trays. Remove some. [58] 123
 transparencies
 loading, multipurpose feeder 36
 tips 46
 trays
 linking 39
 loading 31
 unlinking 39
 troubleshooting
 cannot open Embedded Web Server 151
 checking an unresponsive printer 123
 contacting customer support 152
 solving basic printer problems 123
 troubleshooting, display
 printer display is blank 125
 troubleshooting, paper feed
 message remains after jam is cleared 128
 troubleshooting, print
 incorrect characters print 132
 incorrect margins on prints 138
 jammed pages are not reprinted 129
 job prints from wrong tray 131
 job prints on wrong paper 131
 jobs do not print 129
 Large jobs do not collate 133
 paper curl 139
 paper frequently jams 128
 print job takes longer than expected 131
 printing slows down 130
 tray linking does not work 132
 unexpected page breaks occur 133
 troubleshooting, print quality
 blank pages 134
 characters have jagged edges 134
 clipped pages or images 135
 gray background on prints 137

- horizontal voids appear on
 - prints 148
- print irregularities 140
- print is too dark 141
- print is too light 143
- printer is printing solid black
 - pages 145
- repeating print defects appear on
 - prints 141
- shadow images appear on
 - prints 136
- skewed print 144
- streaked horizontal lines appear
 - on prints 146
- streaked vertical lines 147
- toner rubs off 150
- toner specks appear on prints 150
- transparency print quality is
 - poor 145
- uneven print density 150
- white streaks on a page 149

troubleshooting, printer options

- internal option is not
 - detected 125
- memory card 127
- tray problems 126

U

- unacceptable paper 43
- uneven print density 150
- Universal paper size
 - setting 30
- Universal Setup menu 62
- unlinking trays 39
- updating options in printer
 - driver 22
- USB port 20
- using
 - Wireless Setup Assistant 27
 - Wireless Setup Utility 27
- using Hibernate mode 84
- using Schedule Power Modes 86
- using the Embedded Web
 - Server 12
- Utilities menu 79

V

- vertical voids appear 149
- viewing
 - reports 99

- virtual display
 - checking, using Embedded Web
 - Server 99
- voids appear 149
- volatile memory 88
 - erasing 89
- volatility
 - statement of 88

W

- Wireless menu 67
- wireless network
 - configuration information 25
- wireless network setup
 - using the Embedded Web
 - Server 28
- Wireless Setup Assistant
 - using 27
- Wireless Setup Utility
 - using 27

X

- XPS menu 80