

**ThinkPad**

# User Guide

ThinkPad T440s

**Note:** Before using this information and the product it supports, be sure to read and understand the following:

- *Safety, Warranty, and Setup Guide*
- *Regulatory Notice*
- “Important safety information” on page vi
- Appendix E “Notices” on page 157

The latest *Safety, Warranty, and Setup Guide* and the *Regulatory Notice* are available on the Lenovo Support Web site at:

<http://www.lenovo.com/ThinkPadUserGuides>

**Second Edition (September 2013)**

© Copyright Lenovo 2013.

LIMITED AND RESTRICTED RIGHTS NOTICE: If data or software is delivered pursuant a General Services Administration “GSA” contract, use, reproduction, or disclosure is subject to restrictions set forth in Contract No. GS-35F-05925.

---

# Contents

<b>Read this first</b> . . . . .	<b>v</b>	Presentations and multimedia. . . . .	35
Important safety information . . . . .	vi	Changing display settings . . . . .	35
Conditions that require immediate action . . . . .	vii	Connecting a projector or an external monitor. . . . .	36
Safety guidelines . . . . .	vii	Setting up a presentation. . . . .	38
		Using dual displays . . . . .	38
<b>Chapter 1. Product overview</b> . . . . .	<b>1</b>	Using audio features . . . . .	39
Locating computer controls, connectors, and indicators. . . . .	1	Using the camera . . . . .	40
Front view. . . . .	1	Using a flash media card. . . . .	40
Right-side view. . . . .	3		
Left-side view . . . . .	5	<b>Chapter 3. You and your computer</b> . . . . .	<b>43</b>
Bottom view . . . . .	6	Accessibility and comfort . . . . .	43
Status indicators . . . . .	8	Ergonomic information. . . . .	43
Locating important product information . . . . .	9	Comfort . . . . .	44
Machine type and model information . . . . .	9	Accessibility information . . . . .	44
FCC ID and IC Certification information . . . . .	9	Traveling with your computer . . . . .	45
Certificate of Authenticity information . . . . .	10	Travel tips. . . . .	45
Genuine Microsoft label . . . . .	11	Travel accessories . . . . .	46
Features . . . . .	11		
Specifications . . . . .	13	<b>Chapter 4. Security</b> . . . . .	<b>47</b>
Operating environment . . . . .	13	Using passwords. . . . .	47
Lenovo programs . . . . .	14	Typing passwords . . . . .	47
Accessing Lenovo programs on the Windows 7 operating system . . . . .	14	Power-on password . . . . .	47
Accessing Lenovo programs on the Windows 8 operating system . . . . .	15	Supervisor password . . . . .	48
Lenovo program overview . . . . .	16	Hard disk passwords . . . . .	49
		Hard disk security . . . . .	51
<b>Chapter 2. Using your computer</b> . . . . .	<b>19</b>	Setting the security chip . . . . .	52
Registering your computer . . . . .	19	Using the fingerprint reader. . . . .	53
Frequently asked questions . . . . .	19	Notice on deleting data from your hard disk drive or solid-state drive . . . . .	56
Using the multi-touch screen . . . . .	21	Using firewalls. . . . .	57
Special keys . . . . .	24	Protecting data against viruses . . . . .	57
Function keys and key combinations . . . . .	24		
Windows key . . . . .	25	<b>Chapter 5. Recovery overview</b> . . . . .	<b>59</b>
Using the ThinkPad pointing device . . . . .	25	Recovery overview for the Windows 7 operating system. . . . .	59
Power management . . . . .	27	Creating and using recovery media . . . . .	59
Checking the battery status. . . . .	27	Performing backup and recovery operations . . . . .	60
Using the ac power adapter. . . . .	28	Using the Rescue and Recovery workspace . . . . .	61
Charging the batteries . . . . .	28	Creating and using a rescue medium . . . . .	62
Maximizing the battery life . . . . .	29	Reinstalling preinstalled programs and device drivers . . . . .	63
Managing the battery power . . . . .	29	Solving recovery problems . . . . .	64
Power-saving modes . . . . .	29	Recovery overview for the Windows 8 operating system. . . . .	64
Handling the battery. . . . .	30	Refreshing your computer . . . . .	64
Connecting to the network . . . . .	31	Resetting your computer to the factory default settings. . . . .	64
Ethernet connections . . . . .	32		
Wireless connections . . . . .	32		

Using the advanced startup options . . . . .	65
Recovering your operating system if Windows 8 fails to start . . . . .	65
Creating and using recovery media . . . . .	65
<b>Chapter 6. Replacing devices . . . . .</b>	<b>67</b>
Static electricity prevention . . . . .	67
Disabling the built-in battery . . . . .	67
Installing or replacing the SIM card . . . . .	68
Replacing the external battery pack . . . . .	69
Replacing the base cover assembly . . . . .	71
Replacing the hard disk drive or solid-state drive . . . . .	72
Replacing a memory module . . . . .	74
Replacing the wireless LAN card . . . . .	75
Replacing the wireless WAN card . . . . .	78
Replacing the keyboard . . . . .	81
Replacing the RTC battery . . . . .	87
<b>Chapter 7. Enhancing your computer . . . . .</b>	<b>89</b>
Finding ThinkPad options . . . . .	89
ThinkPad docking stations . . . . .	89
Locating controls and connectors on the ThinkPad docking stations . . . . .	89
Attaching a ThinkPad docking station . . . . .	94
Detaching a ThinkPad docking station . . . . .	95
Connecting external displays to a docking station . . . . .	96
Security features . . . . .	97
<b>Chapter 8. Advanced configuration . . . . .</b>	<b>99</b>
Installing a new operating system . . . . .	99
Installing the Windows 7 operating system . . . . .	99
Installing the Windows 8 operating system . . . . .	100
Installing device drivers . . . . .	101
Using the ThinkPad Setup program . . . . .	101
Main menu . . . . .	102
Config menu . . . . .	102
Date and Time menu . . . . .	107
Security menu . . . . .	107
Startup menu . . . . .	111
Restart menu . . . . .	113
Updating the UEFI BIOS . . . . .	113
Using system management . . . . .	113
Setting management features . . . . .	114
<b>Chapter 9. Preventing problems . . . . .</b>	<b>117</b>
General tips for preventing problems . . . . .	117
Making sure device drivers are current . . . . .	118
Taking care of your computer . . . . .	119
Cleaning the cover of your computer . . . . .	120

<b>Chapter 10. Troubleshooting computer problems . . . . .</b>	<b>123</b>
Diagnosing problems . . . . .	123
Troubleshooting . . . . .	123
Computer stops responding . . . . .	123
Spills on the keyboard . . . . .	124
Error messages . . . . .	124
Errors without messages . . . . .	125
Beep errors . . . . .	126
Memory module problems . . . . .	127
Networking problems . . . . .	127
Problems with the keyboard and other pointing devices . . . . .	129
Problems with the display and multimedia devices . . . . .	130
Fingerprint reader problems . . . . .	133
Battery and power problems . . . . .	133
Problems with drives and other storage devices . . . . .	136
A software problem . . . . .	137
Problems with ports and connectors . . . . .	137

<b>Chapter 11. Getting support . . . . .</b>	<b>139</b>
Before you contact Lenovo . . . . .	139
Getting help and service . . . . .	139
Using diagnostic programs . . . . .	140
Lenovo Support Web site . . . . .	140
Calling Lenovo . . . . .	140
Purchasing additional services . . . . .	141

<b>Appendix A. Regulatory Information . . . . .</b>	<b>143</b>
Wireless related information . . . . .	143
Locations of the UltraConnect™ wireless antennas . . . . .	144
Locating wireless regulatory notices . . . . .	145
Export classification notice . . . . .	145
Electronic emission notices . . . . .	145
Federal Communications Commission Declaration of Conformity . . . . .	145
Industry Canada Class B emission compliance statement . . . . .	145
European Union - Compliance to the Electromagnetic Compatibility Directive . . . . .	146
German Class B compliance statement . . . . .	146
Korea Class B compliance statement . . . . .	147
Japan VCCI Class B compliance statement . . . . .	147
Japan compliance statement for products which connect to the power mains with rated current less than or equal to 20 A per phase . . . . .	147
Lenovo product service information for Taiwan . . . . .	147

---

Eurasian compliance mark . . . . . 147

**Appendix B. WEEE and recycling statements . . . . . 149**

Important WEEE information . . . . . 149

Recycling information for Japan . . . . . 149

Battery recycling information for Brazil . . . . . 150

Battery recycling information for Taiwan. . . . . 150

Battery recycling information for the European Union . . . . . 151

Battery recycling information for the United States and Canada. . . . . 151

**Appendix C. Restriction of Hazardous Substances Directive (RoHS). . . . . 153**

European Union RoHS . . . . . 153

China RoHS. . . . . 153

India RoHS . . . . . 153

Turkish RoHS . . . . . 153

Ukraine RoHS . . . . . 154

**Appendix D. ENERGY STAR model information . . . . . 155**

**Appendix E. Notices. . . . . 157**

Trademarks . . . . . 158



---

## Read this first

Be sure to follow the important tips given here to get the most use and enjoyment out of your computer. Failure to do so might lead to discomfort or injury, or cause your computer to fail.

### Protect yourself from the heat that your computer generates.



When your computer is turned on or the battery is charging, the base, the palm rest, and some other parts may become hot. The temperature they reach depends on the amount of system activity and the level of charge in the battery.

Extended contact with your body, even through clothing, could cause discomfort or even a skin burn.

- Avoid keeping your hands, your lap, or any other part of your body in contact with a hot section of the computer for any extended time.
- Periodically take hands from using the keyboard by lifting your hands from the palm rest.

### Protect yourself from the heat generated by the ac power adapter.



When the ac power adapter is connected to an electrical outlet and your computer, it generates heat.

Extended contact with your body, even through clothing, may cause a skin burn.

- Do not place the ac power adapter in contact with any part of your body while it is in use.
- Never use it to warm your body.

### Prevent your computer from getting wet.



To avoid spills and the danger of electrical shock, keep liquids away from your computer.

### Protect the cables from being damaged.

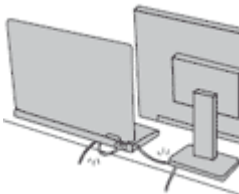

Applying strong force to cables may damage or break them.

Route communication lines, or the cables of an ac power adapter, a mouse, a keyboard, a printer, or any other electronic device, so that they cannot be walked on, tripped over, pinched by your computer or other objects, or in any way subjected to treatment that could interfere with the operation of your computer.

## Protect your computer and data when moving it.



Before moving a computer equipped with a hard disk drive, do one of the following, and make sure that the power button is off or is blinking:

- Turn it off.
- Put it in sleep mode.
- Put it in hibernation mode.

This will help to prevent damage to the computer, and possible loss of data.

## Handle your computer gently.



Do not drop, bump, scratch, twist, hit, vibrate, push, or place heavy objects on your computer, display, or external devices.

## Carry your computer carefully.



- Use a quality carrying case that provides adequate cushioning and protection.
- Do not pack your computer in a tightly packed suitcase or bag.
- Before putting your computer in a carrying case, make sure that it is off, in sleep mode, or in hibernation mode. Do not put a computer in a carrying case while it is turned on.

## Important safety information

**Note:** Read the important safety information first.

This information can help you safely use your notebook computer. Follow and retain all information included with your computer. The information in this document does not alter the terms of your purchase agreement or the Lenovo® Limited Warranty. For more information, see “Warranty Information” in the *Safety, Warranty, and Setup Guide* that comes with your computer.

Customer safety is important. Our products are developed to be safe and effective. However, personal computers are electronic devices. Power cords, power adapters, and other features can create potential safety risks that can result in physical injury or property damage, especially if misused. To reduce these risks, follow the instructions included with your product, observe all warnings on the product and in the operating instructions, and review the information included in this document carefully. By carefully following the information contained in this document and provided with your product, you can help protect yourself from hazards and create a safer computer work environment.

**Note:** This information includes references to power adapters and batteries. In addition to notebook computers, some products (such as speakers and monitors) ship with external power adapters. If you have such a product, this information applies to your product. In addition, computer products contain a coin-sized internal battery that provides power to the system clock even when the computer is unplugged, so the battery safety information applies to all computer products.



## Conditions that require immediate action

Products can become damaged due to misuse or neglect. Some product damage is serious enough that the product should not be used again until it has been inspected and, if necessary, repaired by an authorized servicer.

As with any electronic device, pay close attention to the product when it is turned on. On very rare occasions, you might notice an odor or see a puff of smoke or sparks vent from your product. Or you might hear sounds like popping, cracking or hissing. These conditions might merely mean that an internal electronic component has failed in a safe and controlled manner. Or, they might indicate a potential safety issue. However, do not take risks or attempt to diagnose the situation yourself. Contact the Customer Support Center for further guidance. For a list of Service and Support phone numbers, see the following Web site:

<http://www.lenovo.com/support/phone>

Frequently inspect your computer and its components for damage or wear or signs of danger. If you have any question about the condition of a component, do not use the product. Contact the Customer Support Center or the product manufacturer for instructions on how to inspect the product and have it repaired, if necessary.

In the unlikely event that you notice any of the following conditions, or if you have any safety concerns with your product, stop using the product and unplug it from the power source and telecommunication lines until you can speak to the Customer Support Center for further guidance.

- Power cords, plugs, power adapters, extension cords, surge protectors, or power supplies that are cracked, broken, or damaged.
- Signs of overheating, smoke, sparks, or fire.
- Damage to a battery (such as cracks, dents, or creases), discharge from a battery, or a buildup of foreign substances on the battery.
- A cracking, hissing or popping sound, or strong odor that comes from the product.
- Signs that liquid has been spilled or an object has fallen onto the computer product, the power cord or power adapter.
- The computer product, power cord, or power adapter has been exposed to water.
- The product has been dropped or damaged in any way.
- The product does not operate normally when you follow the operating instructions.

**Note:** If you notice these conditions with a product (such as an extension cord) that is not manufactured for or by Lenovo, stop using that product until you can contact the product manufacturer for further instructions, or until you get a suitable replacement.

## Safety guidelines

Always observe the following precautions to reduce the risk of injury and property damage.

### Service and upgrades

Do not attempt to service a product yourself unless instructed to do so by the Customer Support Center or your documentation. Only use a Service Provider who is approved to repair your particular product.

**Note:** Some computer parts can be upgraded or replaced by the customer. Upgrades typically are referred to as options. Replacement parts approved for customer installation are referred to as Customer Replaceable Units, or CRUs. Lenovo provides documentation with instructions when it is appropriate for customers to install options or replace CRUs. You must closely follow all instructions when installing or replacing parts. The Off state of a power indicator does not necessarily mean that voltage levels inside a

product are zero. Before you remove the covers from a product equipped with a power cord, always make sure that the power is turned off and that the product is unplugged from any power source. If you have any questions or concerns, contact the Customer Support Center.

Although there are no moving parts in your computer after the power cord has been disconnected, the following warnings are required for your safety.

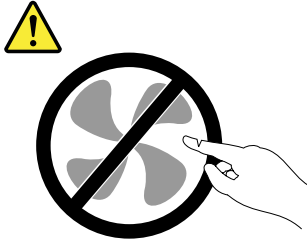

**CAUTION:**  
Hazardous moving parts. Keep fingers and other body parts away.

**CAUTION:**



Before replacing any CRUs, turn off the computer and wait three to five minutes to let the computer cool before opening the cover.

## Power cords and power adapters



**Use only the power cords and power adapters supplied by the product manufacturer.**

**The power cords shall be safety approved. For Germany, it shall be H05VV-F, 3G, 0.75 mm<sup>2</sup>, or better. For other countries, the suitable types shall be used accordingly.**

**Never wrap a power cord around a power adapter or other object. Doing so can stress the cord in ways that can cause the cord to fray, crack, or crimp. This can present a safety hazard.**

**Always route power cords so that they will not be walked on, tripped over, or pinched by objects.**

**Protect power cords and power adapters from liquids. For instance, do not leave your power cord or power adapter near sinks, tubs, toilets, or on floors that are cleaned with liquid cleansers. Liquids can cause a short circuit, particularly if the power cord or power adapter has been stressed by misuse. Liquids also can cause gradual corrosion of power cord terminals and/or the connector terminals on a power adapter, which can eventually result in overheating.**

**Always connect power cords and signal cables in the correct order and ensure that all power cord connectors are securely and completely plugged into receptacles.**

**Do not use any power adapter that shows corrosion at the ac input pins or shows signs of overheating (such as deformed plastic) at the ac input pins or anywhere on the power adapter.**

**Do not use any power cords where the electrical contacts on either end show signs of corrosion or overheating or where the power cord appears to have been damaged in any way.**

To prevent possible overheating, do not cover the power adapter with clothing or other objects when the power adapter is plugged into an electrical outlet.

## Extension cords and related devices

Ensure that extension cords, surge protectors, uninterruptible power supplies, and power strips that you use are rated to handle the electrical requirements of the product. Never overload these devices. If power strips are used, the load should not exceed the power strip input rating. Consult an electrician for more information if you have questions about power loads, power requirements, and input ratings.

## Plugs and outlets



If a receptacle (power outlet) that you intend to use with your computer equipment appears to be damaged or corroded, do not use the outlet until it is replaced by a qualified electrician.

Do not bend or modify the plug. If the plug is damaged, contact the manufacturer to obtain a replacement.

Do not share an electrical outlet with other home or commercial appliances that draw large amounts of electricity; otherwise, unstable voltage might damage your computer, data, or attached devices.

Some products are equipped with a three-pronged plug. This plug fits only into a grounded electrical outlet. This is a safety feature. Do not defeat this safety feature by trying to insert it into a non-grounded outlet. If you cannot insert the plug into the outlet, contact an electrician for an approved outlet adapter or to replace the outlet with one that enables this safety feature. Never overload an electrical outlet. The overall system load should not exceed 80 percent of the branch circuit rating. Consult an electrician for more information if you have questions about power loads and branch circuit ratings.

Be sure that the power outlet you are using is properly wired, easily accessible, and located close to the equipment. Do not fully extend power cords in a way that will stress the cords.

Be sure that the power outlet provides the correct voltage and current for the product you are installing.

Carefully connect and disconnect the equipment from the electrical outlet.

## Power supply statement



Never remove the cover on a power supply or any part that has the following label attached.



Hazardous voltage, current, and energy levels are present inside any component that has this label attached. There are no serviceable parts inside these components. If you suspect a problem with one of these parts, contact a service technician.

## External devices

### CAUTION:

Do not connect or disconnect any external device cables other than USB cables while the computer power is on; otherwise, you might damage your computer. To avoid possible damage to attached devices, wait at least five seconds after the computer is shut down to disconnect external devices.

## General battery notice



**DANGER**

Personal computers manufactured by Lenovo contain a real-time-clock (RTC) battery to provide power to the system clock. In addition, many mobile products, such as notebook computers, utilize a rechargeable battery pack to provide system power when in portable mode. Batteries supplied by Lenovo for use with your product have been tested for compatibility and should only be replaced with approved parts.

Never attempt to open or service any battery. Do not crush, puncture, or incinerate batteries or short circuit the metal contacts. Do not expose the battery to water or other liquids. Only recharge the battery pack strictly according to instructions included in the product documentation.

Battery abuse or mishandling can cause the battery to overheat, which can cause gasses or flame to “vent” from the battery pack or RTC battery. If your battery is damaged, or if you notice any discharge from your battery or the buildup of foreign materials on the battery leads, stop using the battery and obtain a replacement from the battery manufacturer.

Batteries can degrade when they are left unused for long periods of time. For some rechargeable batteries (particularly Lithium Ion batteries), leaving a battery unused in a discharged state could increase the risk of a battery short circuit, which could shorten the life of the battery and also can pose a safety hazard. Do not let rechargeable Lithium-Ion batteries completely discharge or store these batteries in a discharged state.

## Rechargeable battery notice



**DANGER**

Do not attempt to disassemble or modify the battery pack. Attempting to do so can cause an explosion, or liquid leakage from the battery pack. A battery pack other than the one specified by Lenovo, or a disassembled or modified battery pack is not covered by the warranty.

If the rechargeable battery pack is incorrectly replaced, there is danger of an explosion. The battery pack contains a small amount of harmful substances. To avoid possible injury:

- Replace only with a battery of the type recommended by Lenovo.
- Keep the battery pack away from fire.
- Do not expose it to water or rain.
- Do not attempt to disassemble it.
- Do not short-circuit it.

- Keep it away from children.
- Do not drop the battery pack.

Do not put the battery pack in trash that is disposed of in landfills. When disposing of the battery, comply with local ordinances or regulations.

The battery pack should be stored at room temperature, charged to approximately 30 to 50% of capacity. We recommend that battery pack be charged about once per year to prevent overdischarge.

### Notice for lithium RTC battery



Danger of explosion if battery is incorrectly replaced.

Do not:

- Throw or immerse into water
- Heat to more than 100°C (212°F)
- Repair or disassemble

Dispose of the battery as required by local ordinances or regulations.

The following statement applies to users in the state of California, U.S.A.

California Perchlorate Information:

Products containing manganese dioxide lithium RTC batteries may contain perchlorate.

Perchlorate Material - special handling may apply, See [www.dtsc.ca.gov/hazardouswaste/perchlorate](http://www.dtsc.ca.gov/hazardouswaste/perchlorate)

### Notice for built-in rechargeable battery



Do not attempt to replace the internal rechargeable lithium batteries. Contact Lenovo Support for factory replacement.

### Heat and product ventilation



Computers, ac power adapters, and many accessories can generate heat when turned on and when batteries are charging. Notebook computers can generate a significant amount of heat due to their compact size. Always follow these basic precautions:

- When your computer is turned on or the battery is charging, the base, the palm rest, and some other parts may become hot. Avoid keeping your hands, your lap, or any other part of your body in contact with a hot section of the computer for any extended length of time. When you use the keyboard, avoid keeping your palms on the palm rest for a prolonged period of time.

Your computer generates some heat during normal operation. The amount of heat depends on the amount of system activity and the battery charge level. Extended contact with your body, even through clothing, could cause discomfort or even a skin burn. Periodically take breaks from using the keyboard by lifting your hands from the palm rest; and be careful not to use the keyboard for any extended length of time.

- Do not operate your computer or charge the battery near flammable materials or in explosive environments.
- Ventilation slots, fans and/or heat sinks are provided with the product for safety, comfort, and reliable operation. These features might inadvertently become blocked by placing the product on a bed, sofa, carpet, or other flexible surface. Never block, cover, or disable these features.
- When the ac power adapter is connected to an electrical outlet and your computer, it generates heat. Do not place the adapter in contact with any part of your body while using it. Never use the ac power adapter to warm your body. Extended contact with your body, even through clothing, may cause a skin burn.

For your safety, always follow these basic precautions with your computer:

- Keep the cover closed whenever the computer is plugged in.
- Regularly inspect the outside of the computer for dust accumulation.
- Remove dust from vents and any perforations in the bezel. More frequent cleanings might be required for computers in dusty or high-traffic areas.
- Do not restrict or block any ventilation openings.
- Do not operate your computer inside furniture, as this might increase the risk of overheating.
- Airflow temperatures into the computer should not exceed 35°C (95°F).

## Electrical current safety information



**DANGER**

Electric current from power, telephone, and communication cables is hazardous.

To avoid a shock hazard:

- Do not use your computer during a lightning storm.
- Do not connect or disconnect any cables or perform installation, maintenance, or reconfiguration of this product during an electrical storm.
- Connect all power cords to a properly wired and grounded electrical outlet.
- Connect to properly wired outlets any equipment that will be attached to this product.
- Whenever possible, use one hand only to connect or disconnect signal cables.
- Never turn on any equipment when there is evidence of fire, water, or structural damage.
- Do not use your computer until all internal parts enclosures are fastened into place. Never use the computer when internal parts and circuits are exposed.



**Connect and disconnect cables as described in the following procedures when installing, moving, or opening covers on this product or attached devices.**

**To connect:**

1. Turn everything OFF.
2. First, attach all cables to devices.
3. Attach signal cables to connectors.
4. Attach power cords to outlets.
5. Turn devices ON.

**To disconnect:**

1. Turn everything OFF.
2. First, remove power cords from outlets.
3. Remove signal cables from connectors.
4. Remove all cables from devices.

**The power cord must be disconnected from the wall outlet or receptacle before installing all other electrical cables connected to the computer.**

**The power cord may be reconnected to the wall outlet or receptacle only after all other electrical cables have been connected to the computer.**

## Liquid crystal display (LCD) notice

**CAUTION:**

**The liquid crystal display (LCD) is made of glass, and rough handling or dropping the computer can cause the LCD to break. If the LCD breaks and the internal fluid gets into your eyes or on your hands, immediately wash the affected areas with water for at least 15 minutes; if any symptoms are present after washing, get medical care.**

**Note:** For products with mercury-containing fluorescent lamps (for example, non-LED), the fluorescent lamp in the liquid crystal display (LCD) contains mercury; dispose of according to local, state, or federal laws.

## Using headphones or earphones

If your computer has both a headphone connector and an audio-out connector, always use the headphone connector for headphones (also called a headset) or earphones.

**CAUTION:**

**Excessive sound pressure from earphones and headphones can cause hearing loss. Adjustment of the equalizer to maximum increases the earphone and headphone output voltage and the sound pressure level. Therefore, to protect your hearing, adjust the equalizer to an appropriate level.**

Excessive use of headphones or earphones for a long period of time at high volume can be dangerous if the output of the headphone or earphone connectors do not comply with specifications of EN 50332-2. The headphone output connector of your computer complies with EN 50332-2 Sub clause 7. This specification limits the computer's maximum wide band true RMS output voltage to 150 mV. To help protect against hearing loss, ensure that the headphones or earphones you use also comply with EN 50332-2 (Clause 7 limits) for a wide band characteristic voltage of 75 mV. Using headphones that do not comply with EN 50332-2 can be dangerous due to excessive sound pressure levels.

If your Lenovo computer came with headphones or earphones in the package, as a set, the combination of the headphones or earphones and the computer already complies with the specifications of EN 50332-1. If different headphones or earphones are used, ensure that they comply with EN 50332-1 (Clause 6.5 Limitation Values). Using headphones that do not comply with EN 50332-1 can be dangerous due to excessive sound pressure levels.

## Additional safety information



**DANGER**

**Plastic bags can be dangerous. Keep plastic bags away from babies and children to avoid danger of suffocation.**

### Notice for users in the U.S.A.

Many personal computer products and accessories contain cords, cables or wires, such as power cords or cords to connect the accessory to a personal computer. If this product has such a cord, cable or wire, then the following warning applies:

**WARNING:** Handling the cord on this product or cords associated with accessories sold with this product will expose you to lead, a chemical known to the State of California to cause cancer, and birth defects or other reproductive harm. ***Wash hands after handling.***

Save these instructions.



---

## Chapter 1. Product overview

This chapter provides information about the locations of connectors, locations of important product labels, computer features, specifications, operating environment, and preinstalled programs.

- “Locating computer controls, connectors, and indicators” on page 1
- “Locating important product information” on page 9
- “Features” on page 11
- “Specifications” on page 13
- “Operating environment” on page 13
- “Lenovo programs” on page 14

---

### Locating computer controls, connectors, and indicators

This section introduces the computer hardware features to give you the basic information you will need to start using the computer.

#### Front view



Figure 1. Front view

<b>1</b> Camera (on some models)	<b>5</b> TrackPoint® pointing stick
<b>2</b> Microphones	<b>6</b> NFC logo (on some models)
<b>3</b> Power button	<b>7</b> ThinkPad® trackpad
<b>4</b> Fingerprint reader (on some models)	<b>8</b> Screen (multi-touch screen on some models)

#### **1** Camera (on some models)

Use the camera to take pictures or hold a video conference. For more information, see “Using the camera” on page 40.

## **2 Microphones**

The built-in microphones capture sound and voice when used with a program capable of handling audio.

## **3 Power button**

Use the power button to turn on the computer.

To turn off the computer, use the **Start** menu shutdown option on the Microsoft® Windows® 7 operating system. For the Microsoft Windows 8 operating system, move the cursor to the top-right or bottom-right corner of the screen to display the charms. Then click **Settings → Power → Shut down**.

If your computer stops responding and you cannot turn it off, press and hold the power button for four seconds or more. If the computer still is not responding, remove the ac power adapter and use the emergency reset hole to reset the computer. See “Bottom view” on page 6.

You also can program the power button so that by pressing the power button you can turn off the computer or put the computer into sleep or hibernation mode. To achieve this, you need to change your power plan settings. To access power plan settings, do the following:

- For Windows 7: Start the Power Manager program and then click the **Power Plan** tab. For instructions on how to start the Power Manager program, see “Accessing Lenovo programs on the Windows 7 operating system” on page 14.
- For Windows 8: Click the battery status icon from the Windows notification area and click **More power options**. Then click **Choose what the power buttons do**.

## **4 Fingerprint reader (on some models)**

Fingerprint authentication technology provides a simple and secure user access by associating your fingerprint with passwords. For more information, see “Using the fingerprint reader” on page 53.

## **ThinkPad pointing device**

### **5 TrackPoint pointing stick**

### **7 ThinkPad trackpad**

The keyboard contains the Lenovo unique ThinkPad pointing devices. Pointing, selecting, and dragging are all part of a single process that you can perform without moving your fingers from a typing position. For more information, see “Using the ThinkPad pointing device” on page 25.

### **6 NFC logo (on some models)**

If there is a Near Field Communication (NFC) logo on the trackpad, it indicates that your computer supports the NFC feature. For more information, see “Using the NFC connection” on page 35.

### **8 Screen (multi-touch screen on some models)**

For more information, see “Using the multi-touch screen” on page 21.

## Right-side view



Figure 2. Right-side view

<b>1</b> Audio connector	<b>5</b> Ethernet connector
<b>2</b> SIM card tray (on some models)	<b>6</b> Video Graphics Array (VGA) connector
<b>3</b> Media card reader slot	<b>7</b> Security-lock slot
<b>4</b> USB 3.0 connector	

### **1** Audio connector

Connect a headphone or a headset that has a 3.5-mm (0.14-inch) 4-pole plug to the audio connector to listen to the sound from the computer.

#### **Notes:**

- If you are using a headset with a function switch, for example, a headset for an iPhone mobile digital device, do not press this switch while using the headset. If you press the switch, the headset microphone will be disabled, and the integrated microphones on the computer will be enabled instead.
- The audio connector does not support a conventional microphone. For more information, see “Using audio features” on page 39.

### **2** SIM card tray (on some models)

If your computer has a wireless Wide Area Network (wireless WAN) feature, a Subscriber Identification Module (SIM) card might be required to establish wireless WAN connections. Depending on the country of delivery, the SIM card might be already installed in the SIM card tray. For more information, see “Installing or replacing the SIM card” on page 68.

### **3** Media card reader slot

Your computer has a media card reader slot. Insert your flash media card into this slot to read the data on the card. For more information about the supported cards, see “Using a flash media card” on page 40.

### **4** USB 3.0 connector

The Universal Serial Bus (USB) 3.0 connector is used for connecting USB-compatible devices, such as a USB printer or a digital camera.

**Attention:** When you attach a USB cable to the USB 3.0 connector, ensure that the USB mark is facing upward. Otherwise the connector might be damaged.

## **5 Ethernet connector**

Connect the computer to a LAN with the Ethernet connector.



**DANGER**

**To avoid the risk of electrical shock, do not connect the telephone cable to the Ethernet connector. You can only connect an Ethernet cable to this connector.**

The Ethernet connector has two indicators that show the status of the network connection. When the lower-left indicator is solid green, it indicates that the computer connects to a LAN and a session with the network is available. When the lower-right indicator blinks yellow, it indicates that data is being transmitted.

**Note:** If you attach the computer to a docking station, use the Ethernet connector on the docking station to connect to a LAN, not the one on the computer.

## **6 Video Graphics Array (VGA) connector**

Use the VGA connector to connect the computer to a VGA-compatible video device, such as a VGA monitor.

**Note:** If you attach the computer to a docking station, use the VGA connector on the docking station, not the one on the computer.

For more information, see “Using an external monitor” on page 36.

## **7 Security-lock slot**

To protect your computer from theft, you can purchase a security cable lock that fits the security-lock slot to lock the computer to a stationary object.

**Note:** You are responsible for evaluating, selecting, and implementing the locking device and security feature. Lenovo makes no comments, judgments, or warranties about the function, quality, or performance of the locking device and security feature.

## Left-side view

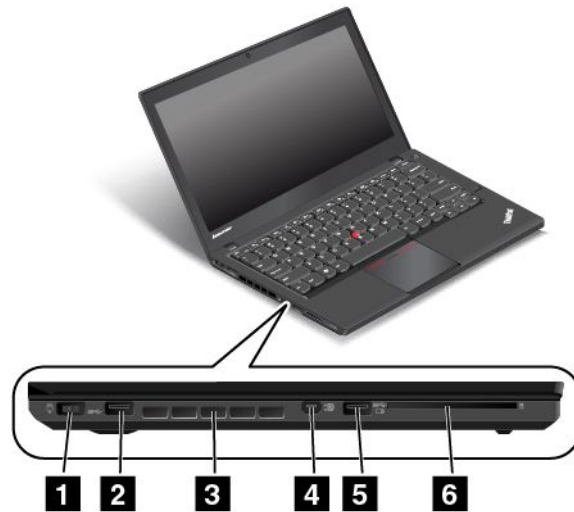

Figure 3. Left-side view

<b>1</b> Power connector	<b>4</b> Mini DisplayPort connector
<b>2</b> USB 3.0 connector	<b>5</b> Always On USB connector
<b>3</b> Fan louvers	<b>6</b> Smart card slot (on some models)

### **1** Power connector

Connect the ac power adapter to the power connector to provide ac power to the computer and charge the battery.

### **2** USB 3.0 connector

The USB 3.0 connector is used for connecting USB-compatible devices, such as a USB printer or a digital camera.

**Attention:** When you attach a USB cable to the USB 3.0 connector, ensure that the USB mark is facing upward. Otherwise the connector might be damaged.

### **3** Fan louvers

The fan louvers and internal fan enable air to circulate in the computer and to ensure proper cooling, especially the cooling of the microprocessor.

**Note:** To ensure proper airflow, do not place any obstacles in front of the fan louvers.

### **4** Mini DisplayPort connector

Use the mini DisplayPort connector to connect your computer to a compatible projector, external monitor, or high-definition television. For more information, see “Using the mini DisplayPort connector” on page 38.

### **5** Always On USB connector

By default, the Always On USB connector enables you to charge some mobile digital devices and smartphones in the following situations:

- When your computer is on or in sleep mode

- When your computer is in hibernation mode or is turned off, but connected to ac power

If you want to charge these devices when the computer is in hibernation mode or is turned off, and the computer is not connected to ac power, do the following:

- For Windows 7: Start the Power Manager program and click the **Global Power Settings** tab. Then select the **Enable USB charge from the computer battery even when the computer is off** check box, and click **OK** or **Apply**.
- For Windows 8: Press the Windows key to go to the Start screen. Click **Lenovo Settings → Power**. Then select the **Enable USB charge from the computer battery even when the computer is off** check box under Always on USB.

**Attention:** When you attach a USB cable to this connector, ensure that the USB mark is facing upward. Otherwise the connector might be damaged.

#### **6 Smart card slot (on some models)**

Your computer might have a smart card slot. For more information, see “Using a flash media card” on page 40.

## **Bottom view**

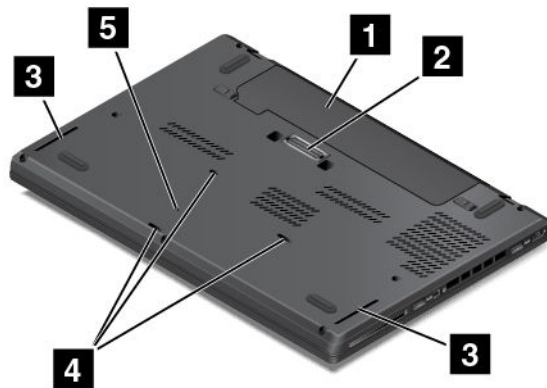

Figure 4. Bottom view

<b>1</b> External battery pack	<b>4</b> Keyboard drainage holes
<b>2</b> Docking station connector (on some models)	<b>5</b> Emergency reset hole
<b>3</b> Speakers	

#### **1 External battery pack**

Use the computer with the battery power whenever ac power is unavailable.

You can use the Power Manager program to adjust your power settings as needed. For detailed information, see the help information system of the Power Manager program.

#### **2 Docking station connector (on some models)**

Depending on the model, the computer might have a docking station connector. You can use the connector to connect the computer to a supported docking station to extend the computer capabilities when you

are at the office or at home. For more information about the supported docking stations, see “ThinkPad docking stations” on page 89.

### **3 Speakers**

Your computer is equipped with a pair of stereo speakers.

### **4 Keyboard drainage holes**

The keyboard drainage holes can help drain out liquid from your computer if you accidentally spill water or drink over the keyboard.

### **5 Emergency reset hole**

If the computer stops responding and you cannot turn it off by pressing the power button, remove the ac power adapter and insert a straightened paper clip into the emergency reset hole to reset the computer.

## Status indicators

The status indicators show the current status of your computer.

**Note:** Your computer might have slight variations from the following illustrations.

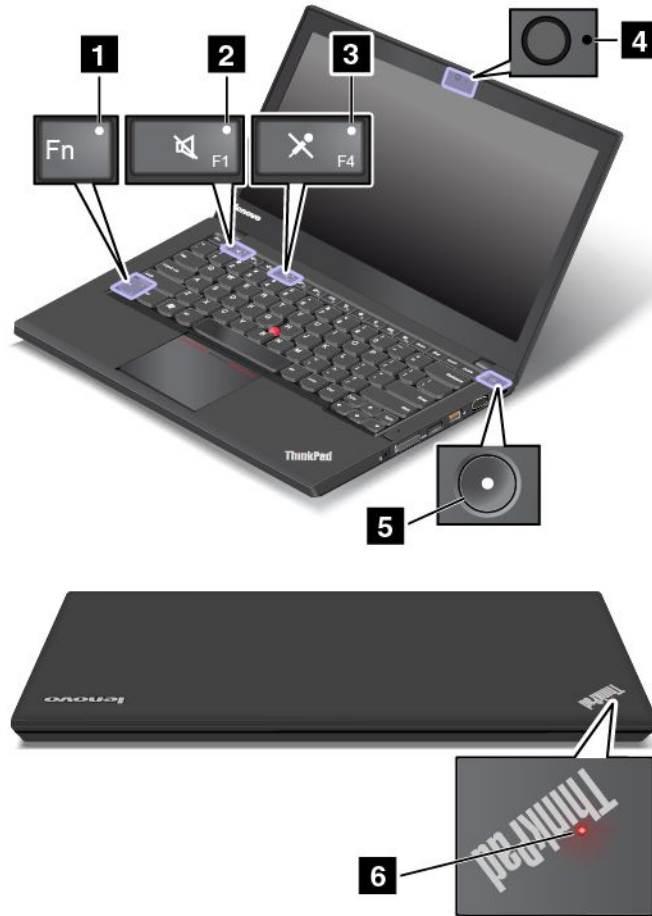

### 1 Fn Lock indicator

The Fn Lock indicator shows the status of Fn Lock function. For more information, see “Special keys” on page 24.

### 2 Speaker mute indicator

When the speaker mute indicator is on, the speakers are muted.

### 3 Microphone mute indicator

When the microphone mute indicator is on, the microphones are muted.

### 4 Camera status indicator

When the camera status indicator is on, the camera is in use.

### 5 6 System status indicators



The indicator in the ThinkPad logo and the indicator in the center of the power button show the system status of the computer.

- **Blinks for three times:** The computer is initially connected to power.
- **On:** The computer is on (in normal mode).
- **Blinks fast:** The computer is entering sleep or hibernation mode.
- **Blinks slowly:** The computer is in sleep mode.
- **Off:** The computer is off or in hibernation mode.

---

## Locating important product information

This section provides information to help you locate the machine type and model label, the FCC ID and IC Certification label, the Windows Certificate of Authenticity label, and the Genuine Microsoft label.

### Machine type and model information

The machine type and model label identifies your computer. When you contact Lenovo for help, the machine type and model information helps support technicians to identify your computer and provide faster service.

The following figure shows the location of the machine type and model of your computer:

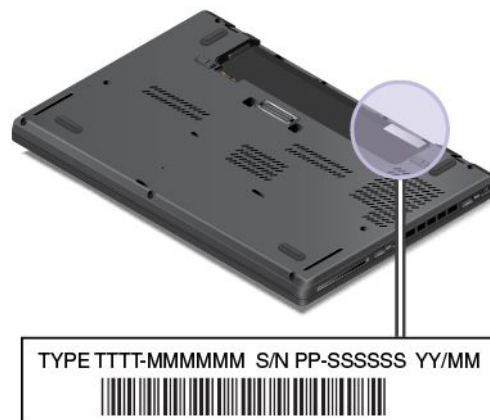

### FCC ID and IC Certification information

There is no FCC ID or IC Certification number for the wireless communication cards shown on the enclosure of the computer. On some models, Lenovo provides you the information about the location of the FCC ID and IC Certification number label on the computer back cover assembly.

The following figure shows where you can find the location information about the FCC ID and IC Certification number labels of the computer.

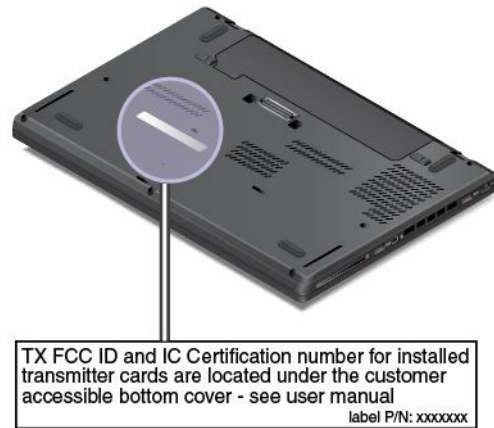

The FCC ID and IC Certification number labels are affixed on the wireless WAN card **1** and wireless LAN card **2** installed in the wireless communication card slots of the computer.

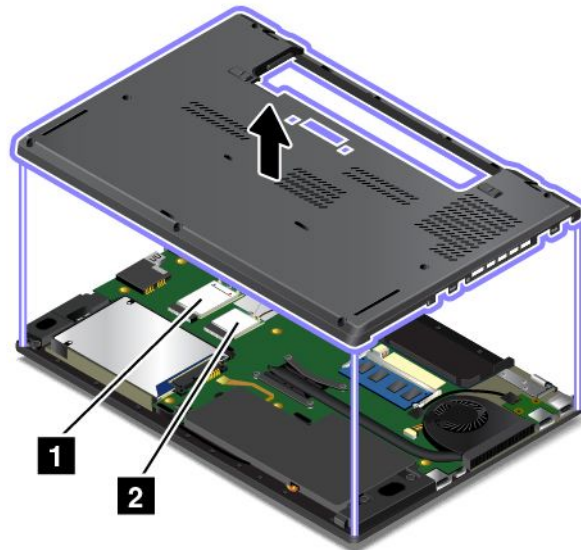

To remove the wireless LAN card for repair or replacement, see “Replacing the wireless LAN card” on page 75.

To remove the wireless WAN card for repair or replacement, see “Replacing the wireless WAN card” on page 78.

**Note:** Use only Lenovo-authorized wireless communication cards for the computer. If you install an unauthorized wireless communication card that is not approved for use in your computer, an error message will be displayed and the computer will beep when you turn on the computer.

## Certificate of Authenticity information

The Certificate of Authenticity label is provided on models that are licensed to use a Windows 7 operating system. The licensed Windows version and product key associated with the computer are printed on this label. Record this information and keep it in a safe place. You might need these numbers to start your computer or reinstall the Windows 7 operating system. Depending on the model, the Certificate of Authenticity label can be on the computer cover, under the external battery, or on the power adapter.

For more information about the Certificate of Authenticity label, go to:  
<http://www.microsoft.com/en-us/howtotell/Hardware.aspx>

The following figure shows the location of the Certificate of Authenticity label on the computer cover:



## Genuine Microsoft label

The Genuine Microsoft label is provided on models that are licensed to use a Windows 8 operating system. The version of the Windows 8 operating system is printed on the label. If your computer model is licensed to use the Windows 8 Pro operating system, that license also permits you to use the Windows 7 Professional operating system in place of the Windows 8 Pro operating system if you prefer. Lenovo computers that are licensed for use with a Windows 8 operating system are shipped with the Windows 8 license key digitally encoded into the computer hardware. Depending on the computer model, the Genuine Microsoft label can be on the computer cover, under the battery, or on the power adapter.

For more information about the Genuine Microsoft label, go to:  
<http://www.microsoft.com/en-us/howtotell/Hardware.aspx>

The following figure shows the location of the Genuine Microsoft label on the computer cover:



---

## Features

This topic provides information about the computer features.

### Microprocessor

- To view the microprocessor information of your computer, do the following:
  - For Windows 7: Click **Start**, right-click **Computer**, and then click **Properties**.
  - For Windows 8: Move the cursor to the top-right or bottom-right corner of the screen to display the charms. Then click **Settings → PC info**.

### Memory

- Double data rate 3 low voltage synchronous dynamic random access memory (DDR3 LV SDRAM)

### **Storage device**

Depending on the model:

- 2.5-inch form factor, 7- mm height hard disk drive
- 2.5-inch form factor, 9.5- mm height hard disk drive
- 2.5-inch form factor, 7- mm height solid-state drive
- M.2 solid-state drive for caching only

### **Display**

- Color display with the thin-film transistor (TFT) technology
- Display size: 355.6 mm (14 inches)
- Display resolution: 1600-by-900
- Brightness control
- Integrated camera (on some models)
- Integrated microphones
- Multi-touch technology (on some models)

### **Keyboard**

- 6-row keyboard (backlight function on some models)
- Fn key function
- ThinkPad trackPoint pointing device and trackpad

### **Interface**

- 4-in-1 digital media card reader
- Combo audio connector
- Docking station connector (on some models)
- External monitor connectors (VGA and Mini DisplayPort)
- One Always on USB 3.0 connector
- USB 3.0 connectors
- RJ45 Ethernet connector
- Smart card reader (on some models)

### **GPS and wireless features**

- Global Positioning System (GPS) satellite receiver (on models with wireless WAN)
- Integrated Bluetooth
- Integrated wireless LAN
- Integrated wireless WAN (on some models)
- NFC (on some models)

### **Security feature**

- Fingerprint reader (on some models)

---

## Specifications

### Size

- Width: 331 mm (13 inches)
- Depth: 226 mm (8.9 inches)
- Height: 20.65 mm (0.8 inch)

### Heat output

- 45 W (154 Btu/hr) maximum
- 65 W (222 Btu/hr) maximum

### Power source (ac power adapter)

- Sine-wave input at 50 to 60 Hz
- Input rating of the ac power adapter: 100 to 240 V ac, 50 to 60 Hz

### Battery status

- For the percentage of remaining battery power, check the battery status icon in the Windows notification area.

---

## Operating environment

This section provides information about the operating environment of the computer.

### Environment

- Maximum altitude without pressurization: 3048 m (10 000 ft)
- Temperature
  - At altitudes up to 2438 m (8000 ft)
    - Operating: 5.0°C to 35.0°C (41°F to 95°F)
    - Storage: 5.0°C to 43.0°C (41°F to 109°F)
  - At altitudes above 2438 m (8000 ft)  
Maximum temperature when operating under the unpressurized condition: 31.3°C (88°F)
- **Note:** When you charge the battery, its temperature must be at least 10°C (50°F).
- Relative humidity:
  - Operating: 8% to 95% at wet bulb: 23°C (73°F)
  - Storage: 5% to 95% at wet bulb: 27°C (81°F)

If possible, place your computer in a well-ventilated and dry area without direct exposure to sunshine.

**Attention:** Keep electrical appliances such as an electric fan, radio, high-powered speakers, air conditioner, and microwave oven away from your computer. The strong magnetic fields generated by electrical appliances can damage the monitor and data on the hard disk drive or solid-state drive.

Do not place any beverages on top of or beside the computer or other attached devices. If liquid is spilled on or in the computer or an attached device, a short circuit or other damage might occur.

Do not eat or smoke over your keyboard. Particles that fall into your keyboard can cause damage.

---

## Lenovo programs

Your computer comes with Lenovo programs to help you work easily and securely. The available programs might vary depending on the preinstalled Windows operating system.

To learn more about the programs and other computing solutions offered by Lenovo, go to:  
<http://www.lenovo.com/support>.

## Accessing Lenovo programs on the Windows 7 operating system

On the Windows 7 operating system, you can access Lenovo programs from either the Lenovo ThinkVantage® Tools program or from Control Panel.

### Accessing Lenovo programs from the Lenovo ThinkVantage Tools program

To access Lenovo programs from the Lenovo ThinkVantage Tools program, click **Start → All Programs → Lenovo ThinkVantage Tools**. Then double-click a program icon to access the program.

**Note:** If a program icon is dimmed in the navigation window of the Lenovo ThinkVantage Tools program, it indicates that you need to manually install the program. To install the program, double-click the program icon. Then, follow the instructions on the screen. When the installation process completes, the program icon will be activated.

The following table lists the programs in the Lenovo ThinkVantage Tools program.

**Note:** Depending on the model, some of the programs might not be available.

Table 1. Programs in the Lenovo ThinkVantage Tools program

Program	Icon name
Access Connections™	Internet Connections
Active Protection System™	Airbag Protection
Client Security Solution	Enhanced Security
Communications Utility	Web Conferencing
Fingerprint Manager Pro	Fingerprint Reader
Lenovo Solution Center	System Health and Diagnostics
Mobile Broadband Connect	3G Mobile Broadband
Password Manager	Password Vault
Power Manager	Power Controls
Recovery Media	Factory Recovery Disks
Rescue and Recovery®	Enhanced Backup and Restore
System Update	Update and Drivers

### Accessing Lenovo programs from Control Panel

To access Lenovo programs from Control Panel, click **Start → Control Panel**. Then depending on the program you want to access, click the corresponding section and then click the corresponding green text.

**Note:** If you do not find the program you need in Control Panel, open the navigation window of the Lenovo ThinkVantage Tools program and double-click the dimmed icon to install the program you need. Then,

follow the instructions on the screen. When the installation process completes, the program icon will be activated, and you can find the program in Control Panel.

The following table lists the programs, the corresponding sections and green texts in Control Panel.

**Note:** Depending on the model, some of the programs might not be available.

Table 2. Programs in Control Panel

Program	Control Panel section	Green text in Control Panel
Access Connections	Network and Internet	Lenovo - Internet Connections
Active Protection System	System and Security	Lenovo - Airbag Protection
	Hardware and Sound	
Client Security Solution	System and Security	Lenovo - Enhanced Security
Communications Utility	Hardware and Sound	Lenovo - Web Conferencing
Fingerprint Manager Pro	System and Security	Lenovo - Fingerprint Manager Pro or Lenovo - Notebook Fingerprint Reader
	Hardware and Sound	
Lenovo Solution Center	System and Security	Lenovo - System Health and Diagnostics
Message Center Plus	Programs	Messages from Lenovo
Mobile Broadband Connect	Network and Internet	Lenovo - 3G Mobile Broadband
Password Manager	System and Security	Lenovo - Password Vault
	User Accounts and Family Safety	
Power Manager	Hardware and Sound	Lenovo - Power Controls
	System and Security	
Recovery Media	System and Security	Lenovo - Factory Recovery Disks
System Update	System and Security	Lenovo - Update and Drivers
Rescue and Recovery	System and Security	Lenovo - Enhanced Backup and Restore

## Accessing Lenovo programs on the Windows 8 operating system

If your computer is preinstalled with the Windows 8 operating system, you can access Lenovo programs by doing either of the following:

- Click the **Lenovo QuickLaunch** icon from the taskbar. A list of programs is displayed. Double-click a Lenovo program to launch it. If a desired program is not in the list, click the plus icon +.
- Press the Windows key to go to the Start screen. Click a Lenovo program to launch it. If you cannot find the program you need, move the cursor to the top-right or bottom-right corner of the screen to display the charms. Then click the **Search** charm to search for the desired program.

Your computer supports the following Lenovo programs:

- Active Protection System
- Fingerprint Manager Pro

- Lenovo Companion
- Lenovo Mobile Access
- Lenovo QuickCast
- Lenovo QuickControl
- Lenovo QuickDisplay
- Lenovo Settings
- Lenovo Solution Center
- Lenovo Support
- Lenovo ThinkVantage Tools
- Password Manager
- System Update

**Note:** The Password Manager program is not preinstalled on Windows 8 computers. You can download the Password Manager program from the Lenovo Support Web site <http://www.lenovo.com/support>.

## Lenovo program overview

This topic provides information about some Lenovo programs.

**Note:** Depending on the model, some of the programs might not be available.

- **Access Connections**

The Access Connections program is a connectivity assistant program for creating and managing location profiles. Each location profile stores all the network and Internet configuration settings needed for connecting to a network infrastructure from a specific location such as a home or an office.

By switching between location profiles as you move your computer from place to place, you can quickly and easily connect to a network with no need to reconfigure your settings manually and restart the computer each time.

- **Active Protection System**

The Active Protection System program protects your hard disk drive when the shock sensor inside your computer detects a condition that could damage the drive, such as system tilt, excessive vibration, or shock. The hard disk drive is less vulnerable to damage when it is not operating. This is because when the hard disk drive is not operating, the system stops it from spinning, and might also move the read and write heads of the drive to areas that do not contain data. As soon as the shock sensor senses that the environment is stable again (minimal change in system tilt, vibration, or shock), it turns the hard disk drive on.

- **Client Security Solution**

The Client Security Solution program protects your computer by securing client data and deflecting security breach attempts. It also can help manage your passwords, recover a forgotten password, monitor security settings on your computer, and suggest how to enhance your computer security.

- **Communications Utility**

The Communications Utility program enables you to configure settings for the integrated camera and audio devices.

- **Fingerprint Manager Pro**

If your computer comes with a fingerprint reader, the Fingerprint Manager Pro program enables you to enroll your fingerprint and associate it with your Windows password. As a result, the fingerprint authentication can replace your password and enable simple and secure user access.

- **Lenovo Companion**



Through the Lenovo Companion program, you can get the information about the accessories for your computer, view blogs and articles about your computer, and check for other recommended programs.

- **Lenovo Mobile Access**

The Lenovo Mobile Access program enables you to manage your mobile broadband connection. You can create an account, add money to the account, and purchase mobile broadband sessions using your account.

- **Lenovo QuickCast**

The Lenovo QuickCast program provides you with a quick and easy way to send files and uniform resource locators (URLs) between two devices.

- **Lenovo QuickControl**

The Lenovo QuickControl program enables you to control your computer remotely through your smartphone, such as controlling the cursor, changing projection settings, and managing foreground applications and windows.

- **Lenovo QuickDisplay**

The Lenovo QuickDisplay program enables you to establish a connection between your computer and a Wi-Fi display projector. This provides you with a quick and easy way to make presentations.

- **Lenovo Settings**

The Lenovo Settings program enables you to enhance your computing experience by turning your computer into a portable hotspot, configuring camera and audio settings, optimizing your power settings, and creating and managing multiple network profiles.

- **Lenovo Solution Center**

The Lenovo Solution Center program enables you to troubleshoot and resolve computer problems. It combines diagnostic tests, system information collection, security status, and support information, along with hints and tips for optimal system performance.

- **Lenovo Support**

The Lenovo Support program enables you to register your computer with Lenovo, check the computer health condition and battery status, download and view user manuals for your computer, get the warranty information of your computer, and explore help and support information.

- **Lenovo ThinkVantage Tools**

The Lenovo ThinkVantage Tools program helps you work more easily and securely by providing easy access to various programs, such as Fingerprint Manager Pro, Lenovo Solution Center, and so on.

- **Message Center Plus**

The Message Center Plus program automatically displays messages to inform you about important notices from Lenovo, such as alerts on system updates and alerts on conditions that require your attention.

- **Mobile Broadband Connect**

The Mobile Broadband Connect program enables your computer to connect to the mobile broadband network through a supported wireless WAN card.

- **Password Manager**

The Password Manager program automatically captures and fills in authentication information for Windows programs and Web sites.

- **Power Manager**

The Power Manager program provides convenient, flexible, and complete power management for your computer. It enables you to adjust your computer power settings to achieve the best balance between performance and power saving.

- **Recovery Media**

The Recovery Media program enables you to restore the contents of the hard disk drive to the factory default settings.

- **Rescue and Recovery**

The Rescue and Recovery program is a one-button recovery and restore solution. It includes a set of self-recovery tools to help you diagnose computer problems, get help, and recover from system crashes, even if you cannot start the Windows operating system.

- **System Update**

The System Update program enables you to keep the software on your computer up-to-date by downloading and installing software update packages (Lenovo programs, device drivers, UEFI BIOS updates, and other third party programs).

---

## Chapter 2. Using your computer

This chapter provides information on using some of the computer components.

- “Registering your computer” on page 19
- “Frequently asked questions” on page 19
- “Using the multi-touch screen” on page 21
- “Special keys” on page 24
- “Using the ThinkPad pointing device” on page 25
- “Power management” on page 27
- “Connecting to the network” on page 31
- “Using the NFC connection” on page 35
- “Presentations and multimedia” on page 35
- “Using audio features” on page 39
- “Using the camera” on page 40
- “Using a flash media card” on page 40

---

### Registering your computer

When you register your computer, information is entered into a database, which enables Lenovo to contact you in case of a recall or other severe problem. In addition, some locations offer extended privileges and services to registered users.

When you register your computer with Lenovo, you also will receive the following benefits:

- Quicker service when you call Lenovo for help
- Automatic notification of free software and special promotional offers

To register your computer with Lenovo, do one of the following:

- Go to <http://www.lenovo.com/register> and follow the instructions on the screen to register your computer.
- Connect your computer to the Internet and register your computer through a preinstalled registration program:
  - For Windows 7: The preinstalled Lenovo Product Registration program launches automatically after you have used your computer for a time. Follow the instructions on the screen to register your computer.
  - For Windows 8: Open the Lenovo Support program. Then click **Registration** and follow the instructions on the screen to register your computer.

---

### Frequently asked questions

This topic provides a few tips that will help you optimize the use of your ThinkPad notebook computers.

To ensure that you receive the best performance from your computer, browse the following Web page to find information such as aids for troubleshooting and answers to frequently asked questions:

<http://www.lenovo.com/support/faq>

#### Can I get my user guide in another language?

- To download the user guide in another language, go to <http://www.lenovo.com/support>. Then follow the instructions on the screen.

### **How do I use battery power more effectively when I am on the go?**

- To conserve power, or to suspend operation without exiting programs or saving files, see “Power-saving modes” on page 29.
- To achieve the best balance between performance and power saving, change power plan settings. See “Managing the battery power” on page 29.
- If your computer will be turned off for an extended period of time, remove the external battery pack, and follow the instructions in “Disabling the built-in battery” on page 67 to disable the internal built-in battery so as to prevent battery power from draining.

### **How do I securely dispose of data stored on the hard disk drive or solid-state drive?**

- Study Chapter 4 “Security” on page 47 to find out how you can protect your computer from theft and unauthorized use.
- Use the Password Manager program to protect the data stored on your computer. For more information, see the help information system of the program.
- Before you dispose of the data on the hard disk drive or the solid-state drive, be sure to read the topic “Notice on deleting data from your hard disk drive or solid-state drive” on page 56.

### **How do I get connected in different locations?**

- To troubleshoot a wireless networking issue, go to <http://www.lenovo.com/support/faq>.
- Take advantage of the networking features provided by the Access Connections program (on the Windows 7 operating system) or Location Awareness in the Lenovo Settings program (on the Windows 8 operating system).
- To learn more about using the wireless features of your computer, refer to “Wireless connections” on page 32.
- To travel more confidently, be sure to check the tips in “Traveling with your computer” on page 45.
- Press F8 to enable or disable the wireless features.

### **How do I give presentations or attach an external monitor?**

- Ensure that you follow the procedure in the topic “Using an external monitor” on page 36.
- With the Extend desktop function, you can display output on both the computer display and the external monitor. See “Using dual displays” on page 38.

### **I have been using the computer for some time already, and it is getting slower. What should I do?**

- Follow the “General tips for preventing problems” on page 117.
- Diagnose problems yourself by using the preinstalled diagnostic software. See “Diagnosing problems” on page 123.
- A recovery tool is provided on your computer hard disk drive or solid-state drive. For more information, see Chapter 5 “Recovery overview” on page 59.

### **Print the following sections and keep them with your computer in case you are unable to access this online help when necessary.**

- “Installing a new operating system” on page 99
- “Computer stops responding” on page 123
- “Power problems” on page 134

---

## Using the multi-touch screen

This topic provides instructions on how to use the multi-touch screen that is available on some models.

### Tap

Tap on the screen with your fingertip to launch an application, select an item, or open a menu.

### Press and hold

Press and hold an item or a blank area on the screen for a few seconds until an action occurs.

### Drag

Tap and hold your finger on an item, such as an image or an icon on the screen, then pull it along with your finger to the desired location.

### Swipe or slide

Move your finger horizontally on the screen to scroll through Web pages, lists, picture thumbnails, and so on.

### Zoom in or zoom out

Move two fingers closer together on the screen to zoom out, or move two fingers apart on the screen to zoom in.

### Rotate

Put two or more fingers on an item, and then rotate your fingers. This operation enables you to rotate the selected items in a direction you move your fingers.

### Double tap

For some applications, quickly tap twice on the screen to zoom in. Double-tap again to zoom out.

### Windows 8 touch gestures and mouse actions

The following table lists the touch gestures and mouse actions supported by the Window 8 operating system.

**Note:** Your computer screen might look different from the following illustrations.

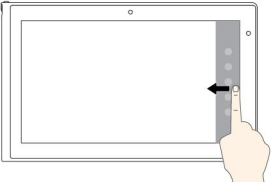
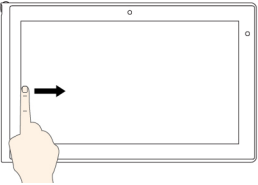
Tasks	Touch gestures (touch models only)	Mouse actions
To display the charms that contain system commands, such as <b>Start</b> , <b>Settings</b> , <b>Search</b> , <b>Share</b> , and <b>Devices</b>	Swipe in from the right edge. 	Move the pointer to the lower-right or upper-right corner of your screen.
To display the open applications and switch applications	Swipe in from the left edge. 	Move the pointer to the upper-left corner of your screen, and then click.

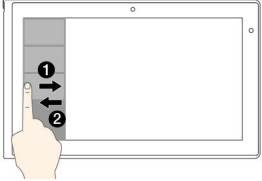
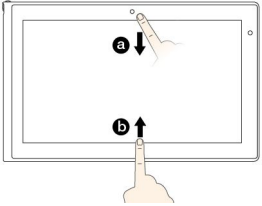
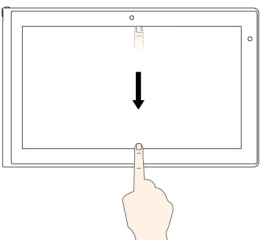
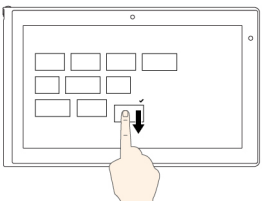
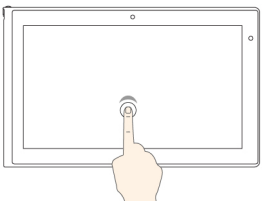
Tasks	Touch gestures (touch models only)	Mouse actions
To view the recently used applications or select an application from the list	Swipe in and out on the left edge. 	Move the pointer to the upper-left corner of your screen, and then move it downward.
To view all applications on the <b>Start</b> screen or view the application commands on an open application, such as <b>Copy</b> , <b>Save</b> , and <b>Delete</b> , depending on the applications	Swipe in from the top or bottom edge. 	Right-click a blank area on the <b>Start screen</b> or right-click an open application.
To close the current application	Swipe in from the top edge to the bottom. 	Click the top of the application, and then drag it to the bottom of your screen.
To enlarge or reduce the size of an icon, remove an icon from the <b>Start</b> screen, or remove an application	Move the desired icon downward until a tick icon (✓) is displayed, then release your finger. 	Right-click the desired icon.
To open an application on the <b>Start</b> screen or perform an action on an open application, such as <b>Copy</b> , <b>Save</b> , and <b>Delete</b> , depending on the application	Tap. 	Click.

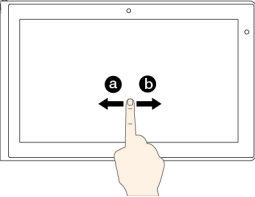
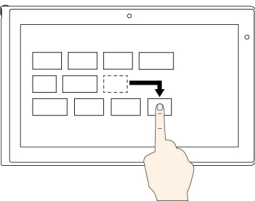
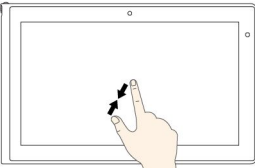
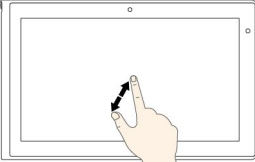
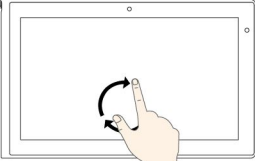
Tasks	Touch gestures (touch models only)	Mouse actions
To scroll through items, such as lists, pages, and photos	Slide. 	Scroll the mouse wheel, move the scroll bar, or click the scroll arrow.
To move an object	Drag an item to the desired location. 	Click, hold, and drag an item.
To zoom out	Move two fingers closer together. 	Press the Ctrl key while scrolling the mouse wheel backward.
To zoom in	Move two fingers farther apart. 	Press the Ctrl key while scrolling the mouse wheel forward.
To rotate an item	Put two or more fingers on an item, and then rotate your fingers (supported only on some models). 	If the application supports rotation, click the rotation icon.

---











## Special keys

Your computer has several special keys to help you work easily and effectively.





### Function keys and key combinations

The keyboard has several function keys, which consist of the Fn key **1** and the function keys **2**.



-  +  Enables or disables the Fn Lock function.  
**When the Fn Lock function is disabled:** The Fn Lock indicator is off (default mode). To initiate the special function of each key, press the function keys directly. To input F1–F12, press the Fn key and the corresponding function key.  
**When the Fn Lock function is enabled:** The Fn Lock indicator is on. To input F1–F12, press the function keys directly. To initiate the special function of each key, press Fn and the corresponding function key.
-  Mutes or unmutes the speakers. When the speakers are muted, the indicator on the F1 key is on.  
If you mute the sound and turn off your computer, the sound will remain muted when you turn on your computer again. To turn on the sound, press F2 or F3.
-  Decreases the speaker volume.
-  Increases the speaker volume.
-  Mutes or unmutes the microphones. When the microphones are muted, the indicator on the F4 key is on.
-  Darkens the display.
-  Brightens the display.
-  Switches the display output location between the computer display and an external monitor.
-  Enables or disables the wireless features.



-  For Windows 7: Opens **Control Panel**. For Windows 8: Opens the **Settings** charm.
-  For Windows 7: Opens **Windows Search**. For Windows 8: Opens the **Search** charm.
-  Views all the programs that you have opened.
-  For Windows 7: Opens **Computer**. For Windows 8: Views all the programs.

- **Fn+Spacebar:** Controls the keyboard backlight.

There are three modes for the keyboard backlight: **Off**, **Low**, and **High**. Press Fn+Spacebar to change the modes of the keyboard backlight.

- **Fn+B:** Has the same function as the Break key on a conventional keyboard.
- **Fn+K:** Has the same function as the ScrLK key on the conventional keyboard.
- **Fn+P:** Has the same function as the Pause key on the conventional keyboard.
- **Fn+S:** Has the same function as the SysRq key on the conventional keyboard.

## Windows key



On the Windows 7 operating system, press the Windows key **1** to open the **Start** menu. On the Windows 8 operating system, press the Windows key to switch between the current workspace and the Start screen.

You also can use the Windows key together with another key to achieve other functions. For more information, refer to the help information system of the Windows operating system.

---

## Using the ThinkPad pointing device

The ThinkPad pointing device consists of a pointing stick **1** on the keyboard and the trackpad **2**. The whole trackpad is an active area sensitive to finger movement. The left click zones **3** and right click zones **5** work as the left and right mouse buttons on a conventional mouse. The scroll zone **4** enables you to scroll Web pages or documents in any direction.

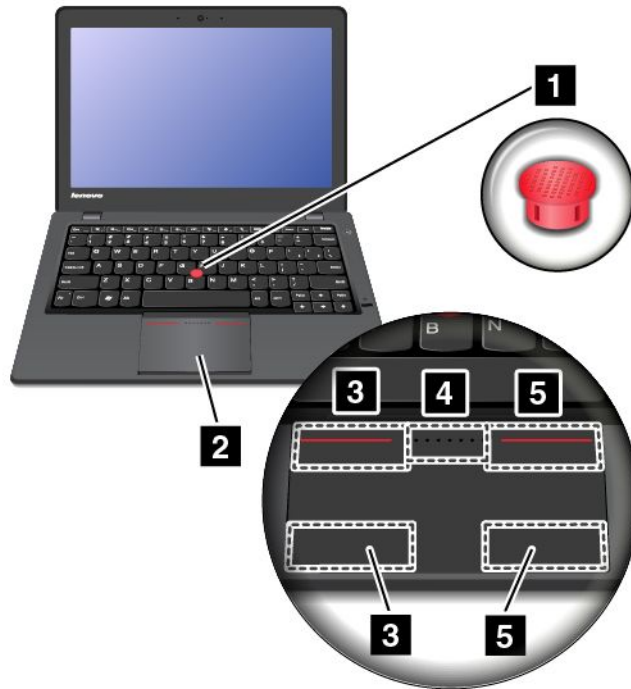

### Using the TrackPoint pointing stick

To use the TrackPoint pointing stick, apply pressure to the nonslip cap on the pointing stick in any direction parallel to the keyboard. Then you can move the cursor. But the pointing stick itself does not move. The speed at which the cursor moves depends on the pressure you apply to the pointing stick.

### Using the multi-touch trackpad

The ThinkPad trackpad of your computer supports multi-touch with which you can zoom in, zoom out, or scroll on the screen while browsing the Internet or reading or editing a document.

### Customizing the ThinkPad pointing device

You can customize the ThinkPad pointing device to achieve the extended functions of the ThinkPad pointing device.

To customize the ThinkPad pointing device, do the following:

1. Go to Control Panel.
2. Click **Hardware and Sound** → **Mouse** → **ThinkPad**.
3. Follow the instructions on the screen.

## Replacing the cap

The cap **1** on the end of the TrackPoint pointing stick is removable. After you use the cap for a period of time, you can replace the cap with a new one.

**Note:** The TrackPoint cap used in your computer has grooves **a** as shown in the following illustration. Ensure that you replace the TrackPoint cap with a correct one that has such grooves.

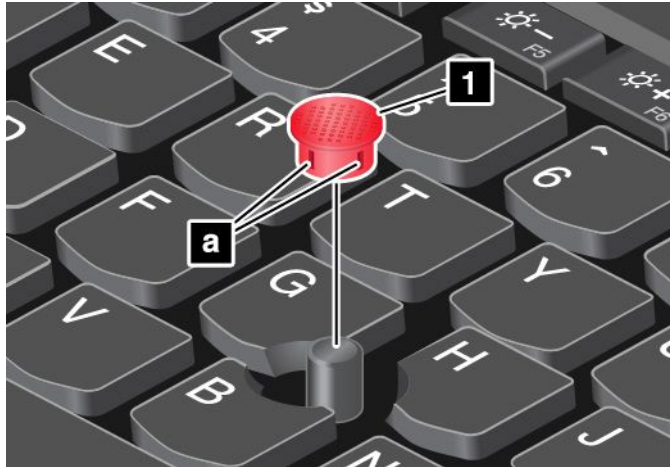

---

## Power management

When you need to use your computer away from electrical outlets, you depend on battery power to keep your computer running. Different computer components consume power at different rates. The more you use the power-intensive components, the faster you consume battery power.

Spend more time unplugged with ThinkPad batteries. Mobility has revolutionized business by enabling you to take your work wherever you go. With ThinkPad batteries, you will be able to work longer without being tied to an electrical outlet.

## Checking the battery status

The battery status icon in the Windows notification area displays the percentage of battery power remaining.

The rate at which you use battery power determines how long you can use the battery of your computer between charges. Because of different user habits and needs, it is difficult to predict how long a battery charge will last. There are two main factors:

- How much energy is stored in the battery when you begin to work.
- The way you use your computer. For example:
  - How often you access the hard disk drive or solid-state drive.
  - How bright you make the computer display.
  - How often you use the wireless features.

To check for detailed battery status information, do the following:

- For Windows 7: Start the Power Manager program and click the **Battery** tab.
- For Windows 8, do one of the following:
  - Start the Lenovo Support program and click **Battery Health**
  - Start the Lenovo Settings program and click **Power**.

## Enabling the battery alarm on the Windows 7 operating system

For the Windows 7 operating system, you can program your computer so that when the battery power falls below a certain level, three events occur: the alarm goes off, a message is displayed, and the LCD is turned off.

To enable the battery alarm, do the following:

1. Start the Power Manager program.
2. Click the **Global Power Settings** tab.
3. For **Low battery alarm** or **Critically low battery alarm**, set the percentage of the power level and set the action.

**Note:** If your computer enters sleep or hibernation mode when the battery is low, but the alarm message has not yet been displayed, the message will be displayed when the computer resumes. To resume normal operation, when the message is displayed, click **OK**.

## Using the ac power adapter

The power to run your computer can come either from the lithium-ion (Li-ion) built-in battery, or from ac power through the ac power adapter. While you use ac power, the batteries charge automatically.

The ac power adapter that comes with your computer has two basic components:

- The transformer pack that converts ac power for use with the computer.
- The power cord that plugs into the ac outlet and into the transformer pack.

**Attention:** Using an improper power cord might cause severe damage to your computer.

### Connecting the ac power adapter

To connect the ac power adapter, do the following:

**Note:** Ensure that you perform the actions in the order in which they are listed.

1. Plug the ac power adapter into an electrical outlet.
2. Connect the power cord to the transformer pack.
3. Connect the ac power adapter to the ac power connector of the computer.

### Tips for using the ac power adapter

- When the ac power adapter is not in use, disconnect it from the electrical outlet.
- Do not bind the power cord tightly around the ac power adapter transformer pack when it is connected to the transformer.
- Before you charge the batteries, make sure that their temperature is at least 10°C (50°F).
- You can charge the batteries when the ac power adapter is connected to the computer. You need to charge the batteries in any of the following situations:
  - When the battery icon in the Windows notification area shows a low percentage of battery power remaining.
  - When the batteries have not been used for a long time

## Charging the batteries

When you check battery status and find that the percentage of power remaining is low or when the power alarm alerts you that the remaining power is low, you need to charge your batteries.

If an ac outlet is convenient, plug the ac power adapter into the outlet, and then plug it into ac power connector of the computer. The batteries will be fully charged in about three to six hours. The charging time is affected by the battery size and the physical environment. You can check the battery charging status at any time through the battery status icon in the Windows notification area.

**Note:** To maximize the life of the batteries, the computer does not start recharging the batteries if the remaining power is greater than 95%.

## Maximizing the battery life

To maximize the life of the battery, do the following:

- Use the batteries until the charge is completely depleted.
- Recharge the batteries completely before using it. You can see whether the batteries are fully charged from the battery status icon in the Windows notification area.
- Always use power-saving modes, such as sleep mode, and hibernation mode.

## Managing the battery power

To achieve the best balance between performance and power saving, adjust your power plan settings. To access power plan settings, do the following:

- For Windows 7: Start the Power Manager program and then click the **Power Plan** tab. For instructions on how to start the Power Manager program, see “Accessing Lenovo programs on the Windows 7 operating system” on page 14.
- For Windows 8: Right-click the battery status icon from the Windows notification area and click **Power Options**. Then click **Change plan settings** next to your power plan.

For more information, refer to the help information system of the program.

## Power-saving modes

There are several modes that you can use at any time to conserve power. This section introduces each mode and gives tips on the effective use of battery power.

- **Screen blank mode (for Windows 7 only)**

The computer display requires considerable battery power. To turn off the power to the display and make the computer enter screen blank mode, right-click the battery gauge icon from the Windows notification area and select **Power off display**.

- **Sleep mode**

In sleep mode, your work is saved to memory, and then the solid-state drive or the hard disk drive and the computer display are turned off. When your computer wakes up, your work is restored within seconds.

Depending on the model, your computer might support the 30 Day Standby function. When this function is enabled, the computer consumes even less power in sleep mode and takes only seconds to resume normal operation when you press the power button. For more information about the 30 Day Standby function, do the following:

- For Windows 7: Refer to the help information system of the Power Manager program. For instructions on how to start the Power Manager program, see “Lenovo programs” on page 14.
- For Windows 8: Open the Lenovo Settings program and click **Power → 30 Day Standby**.

To put your computer into sleep mode, do the following:

- For Windows 7: Use the Start menu shutdown option.
- For Windows 8: Move the cursor to the bottom right corner of the screen to bring up the charms. Then click **Settings → Power → Sleep**.

- **Hibernation mode**

By using this mode, you can turn off your computer completely without saving files or exiting any programs that are running. When the computer enters hibernation mode, all open programs, folders, and files are saved to the hard disk drive or solid-state drive, and then the computer turns off.

If you put your computer into hibernation mode with the wake-up function disabled, the computer does not consume any power. The wake-up function is disabled by default. If you put your computer into hibernation mode with the wake-up function enabled, the computer consumes a small amount of power.

To enable the wake-up function, do the following:

1. Go to Control Panel and click **System and Security**.
2. Click **Administrative Tools**.
3. Click **Task Scheduler**. If you are prompted for an administrator password or confirmation, type the password or provide confirmation.
4. From the left pane, select the task folder for which you want to enable the wake-up function. The scheduled tasks are displayed.
5. Click a scheduled task, and then click the **Conditions** tab.
6. Under **Power**, select the check box for **Wake the computer to run this task**.

To put the computer into hibernation mode, change your power plan settings by doing the following:

- For Windows 7: Start the Power Manager program and then click the **Power Plan** tab. Then follow the instructions on the screen. For instructions on how to start the Power Manager program, see “Lenovo programs” on page 14.
- For Windows 8: Right-click the battery status icon from the Windows notification area and click **Power Options**, click **Change plan settings** that is next to your power plan, and then follow the instructions on the screen.

- **Wireless off**

When you are not using the wireless features, such as Bluetooth or wireless LAN, turn them off. This will help conserve power. To turn off the wireless features, press F8.

## Handling the battery

This system supports only batteries specially designed for this specific system and manufactured by Lenovo or an authorized builder. The system does not support unauthorized batteries or batteries designed for other systems. If an unauthorized battery or a battery designed for another system is installed, the system will not charge.

**Attention:** Lenovo has no responsibility for the performance or safety of unauthorized batteries, and provides no warranties for failures or damage arising out of their use.



**DANGER**

**Do not attempt to disassemble or modify the battery pack.**

**Attempting to do so can cause an explosion, or liquid leakage from the battery pack.**

**A battery pack other than the one specified by Lenovo, or a disassembled or modified battery pack is not covered by the warranty.**

 **DANGER**

If the rechargeable battery pack is incorrectly replaced, there is danger of an explosion. The battery pack contains a small amount of harmful substances. To avoid possible injury:

- Replace only with a battery of the type recommended by Lenovo.
- Keep the battery pack away from fire.
- Do not expose it to excessive heat.
- Do not expose it to water or rain.
- Do not short-circuit it.
- Store it in a cool dry place.
- Keep it away from children.

The battery pack is a consumable supply. If your battery begins to discharge too quickly, replace the battery pack with a new one of the type recommended by Lenovo. For more information on replacing the battery pack, contact your Customer Support Center.

 **DANGER**

Do not drop, crush, puncture, or subject to strong forces. Battery abuse or mishandling can cause the battery to overheat, which can cause gasses or flame to “vent” from the battery pack or RTC battery. If your battery is damaged, or if you notice any discharge from your battery or the buildup of foreign materials on the battery leads, stop using the battery and obtain a replacement from the battery manufacturer.

 **DANGER**

Only recharge the battery pack strictly according to instructions included in the product documentation.

 **DANGER**

Do not put the battery pack in trash that is disposed of in landfills. When disposing of the battery, comply with local ordinances or regulations and your company's safety standards.

 **DANGER**

There is a danger of an explosion if the backup battery is incorrectly placed. The lithium battery contains lithium and can explode if it is not properly handled, or disposed of. Replace only with a battery of the same type. To avoid possible injury or death, do not: (1) throw or immerse into water, (2) allow it to heat to more than 100°C (212°F), or (3) attempt to repair or disassemble it. Dispose of it as required by local ordinances or regulations and your company's safety standards.

---

## Connecting to the network

Your computer has one or more network cards that enable you to connect your computer to the Internet or other network connections.

## Ethernet connections

You can connect your computer to a local network or a broadband connection by using the built-in Ethernet feature of the computer.



**Your computer has an Ethernet connector. To avoid the risk of electrical shock, do not connect the telephone cable to the Ethernet connector.**

## Wireless connections

Wireless connection is the transfer of data without the use of cables but by means of radio waves only.

### Attention:

- If you want to use the wireless features on an airplane, check the wireless services with the airline before boarding the airplane.
- If there are restrictions on the use of computer wireless features on an airplane, you need to disable the wireless features of your computer before boarding.

Depending on the wireless devices installed on your computer, you might be able to use the following wireless networks:

- Wireless LAN connection
- Wireless WAN connection
- Bluetooth connection
- NFC connection

### Using the wireless LAN connection

A wireless local area network (LAN) covers a relatively small geographic area, such as an office building or a house. Devices based on the 802.11 standards can connect to this type of network.

Your computer comes with a built-in wireless network card and a configuration utility to help you establish wireless connections and monitor the connection status. This enables you to stay connected to your network while you are at the office, in a meeting room, or at home, with no need for a wired connection.

To establish a wireless LAN connection, do the following:

#### For Windows 7:

1. Press F8 and follow the instructions on the screen to enable the wireless feature.
2. Click the wireless network connection status icon in the Windows notification area. A list of available wireless networks is displayed.
3. Double-click a network to connect to it. Provide required information if needed.

#### For Windows 8:

1. Press F8 to display the list of available wireless networks. Ensure that the Airplane mode is set to **off**.
2. Double-click a network to connect to it. Provide required information if needed.

If you need to connect to different wireless networks in different locations, use the following software to manage multiple network profiles so that the computer automatically connects to an available network when the location changes:



- For Windows 7: Use the Access Connections program. For more information, see “Accessing Lenovo programs on the Windows 7 operating system” on page 14.
- For Windows 8: Open the Lenovo Settings program and click **Location Awareness**. For more information, see “Accessing Lenovo programs on the Windows 8 operating system” on page 15.

### Tips for using the wireless LAN feature

To achieve the best connection, use the following guidelines:





- Place your computer so that there are as few obstacles as possible between the wireless LAN access point and the computer.
- Open your computer lid to an angle of slightly more than 90 degrees.
- If you use the wireless feature (the 802.11 standards) of your computer simultaneously with a Bluetooth option, the data transmission speed can be delayed and the performance of the wireless feature can be degraded.

### Checking the wireless LAN connection status



You can check the wireless LAN connection status through the wireless network connection status icon in the Windows notification area. The more bars encompassed, the better the signal is.

For the Windows 7 operating system, you also can check the Access Connections gauge, the Access Connections status icon, or the Access Connections wireless status icon in the Windows notification area.







#### Access Connections gauge status:

-  Power to the wireless radio is off or no signal.
-  Power to the wireless radio is on. The signal strength of the wireless connection is poor. To improve signal strength, move your computer closer to the wireless access point.
-  Power to the wireless radio is on. The signal strength of the wireless connection is marginal.
-  Power to the wireless radio is on. The signal strength of the wireless connection is excellent.

#### Access Connections icon status:

-  No location profile is active or none exists.
-  Current location profile is disconnected.
-  Current location profile is connected.

#### Wireless status icon status

-  Power to the wireless radio is off.
-  Power to the wireless radio is on. No association.
-  Power to the wireless radio is on. No signal.
-  Power to the wireless radio is on. The signal strength of the wireless connection is excellent.
-  Power to the wireless radio is on. The signal strength of the wireless connection is marginal.
-  Power to the wireless radio is on. The signal strength of the wireless connection is poor. To improve signal strength, move your computer closer to the wireless access point.

## Using the wireless WAN connection

Wireless Wide Area Network (wireless WAN) which uses cellular networks for data transmission, enables you to establish wireless connections over remote public or private networks. These connections can be maintained over a large geographical area, such as a city or an entire country, by use of multiple antenna sites or satellite systems maintained by wireless service providers.

Some ThinkPad notebook computers come with a built-in wireless WAN card integrated with some wireless WAN technologies, such as 1xEV-DO, HSPA, 3G, GPRS, or LTE. By using the built-in wireless WAN card and the configuration utility that comes with your computer, you can establish wireless WAN connections and monitor the connection status.

**Note:** The wireless WAN service is provided by authorized service providers in some countries.

### Tips for using the wireless WAN feature

To achieve the best connection, use the following guidelines:





- Keep your computer away from your body.
- Place your computer on a flat surface and open your computer lid to an angle of slightly more than 90 degrees.
- Place your computer away from concrete or brick walls that might dampen cellular signals.
- Best reception will be available near windows and other locations where cellular phone reception is the strongest.

### Checking the wireless WAN connection status



You can check the wireless WAN connection status through the wireless network connection status icon in the Windows notification area. The more bars encompassed, the better the signal is.

For the Windows 7 operating system, you also can check the Access Connections gauge, the Access Connections status icon, or the Access Connections wireless status icon in the Windows notification area.





#### Access Connections gauge status:

-  No signal
-  Weak signal
-  Medium signal
-  Strong signal

#### Access Connections icon status:

-  No location profile is active or none exists.
-  Current location profile is disconnected.
-  Current location profile is connected.

#### Wireless status icon status:

-  Power to the WAN radio is off
-  No association
-  No signal
-  Weak signal
-  Medium signal

-  Strong signal

## Using the Bluetooth connection

Bluetooth can connect devices a short distance from one another, and is commonly used for connecting peripheral devices to a computer, transferring data between hand-held devices and a personal computer, or remotely controlling and communicating with devices such as mobile phones.

Depending on the model, your computer might support the Bluetooth feature. To transfer data through the Bluetooth feature, do the following:

1. Ensure that the Bluetooth feature is enabled. If you are using the Windows 8 operating system, the integrated Bluetooth feature is enabled by default. If you are using the Windows 7 operating system, to enable the Bluetooth feature, press F8 then follow the instructions on the screen.
2. Right-click the data that you want to send.
3. Select **Send To → Bluetooth Devices**.
4. Select a Bluetooth device, and then follow the instructions on the screen.

**Note:** If you use the wireless feature (the 802.11 standards) of your computer simultaneously with a Bluetooth option, the data transmission speed can be delayed and the performance of the wireless feature can be degraded.

For more information, refer to the Windows help information system and the Bluetooth help information system.

## Using the NFC connection

NFC is a high-frequency and short-range wireless communications technology. Depending on the model, your computer comes with an NFC card. By using the NFC feature, you can establish the radio communications between the your computer and another NFC-enabled device over a distance no more than a few centimeters.

Before you use the NFC feature, ensure that the NFC feature is enabled. To enable the NFC feature on the Windows 8 operating system, do the following:

1. From the Start screen, tap **Lenovo Settings → Mobile Hotspot**.
2. In the **Enable NFC** area, slide to the right to enable the NFC feature.

You can use the NFC feature with NFC supported programs, such as the Lenovo QuickDisplay program, the Lenovo QuickControl program, or the Lenovo QuickCast program.

---

## Presentations and multimedia

You can connect your computer to a projector to give presentations or you can connect your computer to an external monitor to expand your workspace.

## Changing display settings

You can change the display settings, such as the display resolution, font size, and so on.

To change the display settings, do the following:

1. Open Control Panel and click **Appearance and Personalization**.
2. Click **Display** for further configuration.
3. Click **Apply**. The change will take effect after you log off.

## Connecting a projector or an external monitor

This topic provides information about connecting a projector or an external monitor.

### Using an external monitor

**Note:** When you connect an external monitor, a video interface cable with a ferrite core is required.

Your computer can support a maximum video resolution of up to 2048x1536 (with an external monitor connected to the VGA connector) or up to 2560x1600 (with an external monitor connected to the mini DisplayPort connector), provided that the external monitor also supports that resolution. For more information about the external monitor, refer to the manuals provided with the external monitor.

You can set any resolution for either the computer display or the external monitor. When you use both at the same time, the resolution of both is the same. If you set a higher resolution for the computer display, you can see only part of the screen at a time. You can see other parts by moving the image with the TrackPoint pointing device or another pointing device.

In the Display Settings window, you can move the display output to the computer display, the external monitor, or both.

### Connecting an external monitor

To connect an external monitor, do the following:

1. Connect the external monitor to the VGA connector or the mini DisplayPort connector of your computer.
2. Connect the external monitor to an electrical outlet.
3. Turn on the external monitor.
4. Change the display output location by pressing the F7 key. This enables you to switch between viewing output on the external monitor, the computer monitor, or both monitors.

**Note:** If your computer cannot detect the external monitor, right-click on the desktop, then select **Screen resolution**. Click the **Detect** button.

### Setting the external monitor type

To set the external monitor type, do the following:

1. Connect the external monitor to your computer, and then connect the monitor to an electrical outlet.
2. Turn on the external monitor.
3. Right-click on the desktop, and click **Screen resolution**.

**Note:** If your computer cannot detect the external monitor, click the **Detect** button.

4. Select the external monitor and set **Resolution**.
5. Click **Advanced Settings**.
6. Click the **Monitor** tab. Check the monitor information to make sure that the monitor type is correct. If it is, click **OK** to close the window; otherwise proceed with the following steps.
7. If more than two monitor types are displayed, select **Generic PnP Monitor** or **Generic Non-PnP Monitor**.
8. Click **Properties**. If you are prompted for an administrator password or confirmation, type the password or provide confirmation.
9. Click the **Driver** tab.
10. Click **Update Driver**.

11. Click **Browse my computer for driver software**, and then click **Let me pick from a list of device drivers on my computer**.
12. Clear the **Show compatible hardware** check box.
13. Select the correct manufacturer and model for the external monitor. If you cannot find your monitor on the list, stop the installation of this driver and use the driver shipped with your monitor.
14. After updating the driver, click **Close**.
15. For the Windows 7 operating system, to change the color settings, right-click on the desktop, and click **Screen resolution**. Click **Advanced Settings**, select the **Monitor** tab, then set **Colors**.
16. Click **OK**.

### Considerations for connecting an external monitor

- When installing an operating system, you must install the display driver for your monitor that is provided with the computer, and the monitor INF file that is provided with the external monitor.
- If you set a resolution higher than the resolution you are using on the computer monitor, and use an external monitor that does not support that resolution, take advantage of the virtual screen function, which enables you to display only a part of the high-resolution screen image your computer produces. You can see other parts of the image by moving the screen with the TrackPoint pointing device or another pointing device.
- If the external monitor you are using is outdated, the resolution and the refresh rate might be limited.

### Using a DVI monitor

If your computer has one of the following optional docking stations, you can use a Digital Visual Interface (DVI) monitor through the DVI connector of that unit:

- ThinkPad Pro Dock
- ThinkPad Ultra Dock

#### Notes:

- The screen mode that can be used depends on the specifications of the DVI monitor.
- Before you connect a DVI monitor, make sure that the computer is connected to the expansion unit and works properly.

To connect a DVI monitor, do the following:

1. Turn off the computer.
2. Connect a DVI monitor to the DVI connector of the expansion unit, and then connect the monitor to an electrical outlet.
3. Turn on the DVI monitor and the computer.

If the computer output does not appear on the DVI monitor, do the following:

- For Windows 7:
  1. Press Ctrl+Alt+F12. The Intel® Graphics and Media Control Panel window opens.
  2. Select **Advanced Mode** and click **OK**.
  3. Select **Multiple Displays**.
  4. In the **Operating Mode** field, select one of the following options depending on your needs and follow the instructions on the screen to complete other configurations.
    - **Single Display**: Depending on your configuration, the computer output is displayed either on the computer display or the DVI monitor.

- **Clone Displays:** The same computer output is displayed on both the computer display and the DVI monitor.
- **Extended Desktop:** Different computer output is displayed on the computer display and the DVI monitor.
- For Windows 8:
  1. Move the cursor to the top-right or bottom-right corner of the screen and click the **Devices** charm.
  2. Click **Second screen** and select **Duplicate**, **Extend**, or **Second Screen Only**.

### Considerations for connecting a DVI monitor

Connect a DVI monitor to the expansion unit, and turn on the monitor before you turn on the computer. Otherwise the system cannot recognize that the monitor is connected. If the option for enabling the DVI monitor in the Display Properties window is not displayed, try closing the window and opening it again. If the option still is not displayed, make sure that the connector of the monitor is attached firmly, and repeat the procedure for connecting the monitor.

### Using the mini DisplayPort connector

Your computer has a mini DisplayPort connector, which is a digital display interface for connection to various external devices, such as Cathode Ray Tube (CRT) monitors, LCD monitors, projectors, or even high-definition televisions. This compact connector enables a plug-and-play setup and supports adapters that can plug into DVI, VGA, or High-Definition Multimedia Interface (HDMI) connectors.

The mini DisplayPort connector of your computer supports audio as well as video streaming.

### Setting up a presentation

To display information and make presentations, you can connect a data projector to your computer through the VGA connector on your computer.

**Note:** It may take several seconds before the projector displays the image. If you do not see your desktop displayed after 60 seconds, try pressing the F7 key to switch between different display output locations.

Your projector might have one or more audio-input connectors. To project sound, you need to attach the combo audio connector on your computer to these connectors, using an audio cable (commercially available).

### Using dual displays

This section introduces the Duplicate and Extend desktop functions that enable you to display output on both the computer display and an external monitor.

#### Using the Duplicate or Extend desktop function

With the Duplicate desktop function, you can display the same output on both the computer display and an external display. You also can display different desktop images on each monitor with the Extend desktop function.

You can use the Duplicate or Extend desktop function without changing any settings. If the function does not work, refer to the following topic on how to enable the Duplicate or Extend desktop function.

#### Enabling the Duplicate or Extend desktop function

To enable the Duplicate or Extend desktop function, do the following:

1. Connect the external monitor to your computer; and then connect the monitor to an electrical outlet.
2. Turn on the external monitor.

3. Press F7, then select **Duplicate** or **Extend**.

To change the resolution for each monitor, do the following:

1. Right-click on the desktop, and click **Screen resolution**.
2. Click the **Monitor-1** icon, which is for the primary display (the computer display by default).
3. Set the resolution for the primary display.
4. Click the **Monitor-2** icon, which is for the secondary display (the external display by default).
5. Set the resolution for the secondary display.
6. Click **Advanced settings** and set up the color quality on the **Monitor** tab.
7. Click **OK** to apply the changes.

### Considerations for using the Extend desktop function

- In Extend desktop mode, only the primary display shows DOS full-screen, and the other display is blacked out.
- If your computer has the Intel graphics card, you can designate the primary display by doing the following:
  1. Right-click on the desktop and select **Screen Resolution**.
  2. Click the desired display image and select the **Make this my main display** check box.
  3. Click **OK**.
- When an application using DirectDraw or Direct3D is running in full-screen mode, only the primary display shows the output.
- You cannot use the display switching function when you are in Extend desktop mode.

---

## Using audio features

Your computer is equipped with the following items:

- Built-in microphones
- Built-in speakers
- Combo audio connector, 3.5 mm (0.14 inch) in diameter

Your computer also has an audio chip that enables you to enjoy various multimedia audio features, such as the following:

- Playback of MIDI and MP3 files
- Recording and playback of PCM and WAV files
- Recording from various sound sources, such as a headset attached

The following table shows which functions of the audio devices attached to the connectors on your computer or docking station are supported.

*Table 3. Audio feature list*

Connector	Headset with a 3.5 mm (0.14-inch) 4-pole plug	Conventional headphone	Conventional microphone
Combo audio connector	Headphone and microphone functions supported	Headphone function supported	Not supported

To configure the microphone for optimal sound recording, use the Realtek HD Audio Manager program. To start the program, go to Control Panel and click **Hardware and Sound → Realtek HD Audio Manager**.

---

## Using the camera

If your computer has a camera, you can use the camera to preview your video image and take a snapshot of your current image.

To start the camera, do the following:

- For Windows 7: Start the Communications Utility program. See “Accessing Lenovo programs on the Windows 7 operating system” on page 14.
- For Windows 8: Click **Camera** from the Start screen.

When the camera is started, the green camera-in-use indicator turns on.

You also can use the integrated camera with other programs that provide features such as photographing, video capturing, and video conferencing. To use the integrated camera with other programs, open one of the programs and start the photographing, video capturing, or video conferencing function. Then, the camera will start automatically and the green camera-in-use indicator will turn on. For more information about using the camera with a program, refer to the help information system of the program.

### Configuring camera settings

You can configure the camera settings to meet your needs, such as adjusting the quality of the video output.

To configure the camera settings, do the following:

- For Windows 7: Start the Communications Utility program and configure the camera settings as desired.
- For Windows 8, do one of the following:
  - Configure the camera settings directly from the program that is using the camera. For more information, see the help information system of the program.
  - Click **Lenovo Settings** from the Start screen. Then click **Camera**. Follow the instructions on the screen to configure the camera settings as desired.

---

## Using a flash media card

Your computer might have a media card reader slot or a smart card slot. It supports the following cards:

- MultiMediaCard (MMC)
- Secure Digital eXtended-Capacity (SDXC) card
- Secure Digital (SD) card
- Secure Digital High-Capacity (SDHC) card

**Note:** Your computer does not support the CPRM feature for the SD card.

**Attention:** While transferring data to or from a flash media card, such as an SD card, do not put your computer into sleep or hibernation mode before the data transfer completes; otherwise, your data could be corrupted.

### Inserting a flash media card

**Attention:** Before handling a card, touch a metal object to reduce any static electricity from your body. The static electricity could damage the card.

To insert a flash media card, do the following:



1. Ensure that the card is correctly positioned.
2. Insert the card firmly into the 4-in-1 media card reader slot or smart card slot.

If the plug-and-play feature is not enabled for the installed flash media card, do the following to enable the feature:

1. Open Control Panel.
2. Click **Hardware and Sound**.
3. Click **Device Manager**. If you are prompted for an administrator password or confirmation, type the password or provide confirmation.
4. From the **Action** menu, select **Add legacy hardware**. The Add Hardware Wizard starts.
5. Follow the instructions on the screen.

### Removing a flash media card

#### Attention:

- Stop all the activities involving the card before removing it. Otherwise, data on the card might be damaged or lost.
- Do not remove a card while the computer is in sleep mode or hibernation mode. Otherwise, the system might not respond when you try to resume operation.

To remove a flash media card, do the following:

1. Click the triangular icon in the Windows notification area to show hidden icons. Then, right-click the **Safely Remove Hardware and Eject Media** icon.
2. Select the item you want to remove to stop the card.
3. Press the card to eject it from your computer.
4. Remove the card and store it safely for future use.

**Note:** If you do not remove the card from your computer after you eject the card from the Windows operating system, the card can no longer be accessed. To access the card, you must remove it first, then insert it again.



---

## Chapter 3. You and your computer

This chapter provides information about accessibility, comfort, and traveling with your computer.

- “Accessibility and comfort” on page 43
- “Traveling with your computer” on page 45

---

### Accessibility and comfort

Good ergonomic practice is important to get the most from your personal computer and to avoid discomfort. Arrange your workplace and the equipment you use to suit your individual needs and the kind of work that you perform. In addition, use healthy work habits to maximize your performance and comfort while using your computer.

The following topics provide information about arranging your work area, setting up your computer equipment, and establishing healthy work habits.

Lenovo is committed to providing the latest information and technology to our customers with disabilities. Refer to our accessibility information which outlines our efforts in this area. See “Accessibility information” on page 44.

### Ergonomic information

Working in the virtual office might mean adapting to frequent changes in your environment. For example, adapting to the surrounding light sources, proper seating, and the placement of your computer hardware, can help you improve your performance and achieve greater comfort.

The following example shows someone in a conventional setting. Even when not in such a setting, you can follow many of these tips. Develop good habits, and they will serve you well.

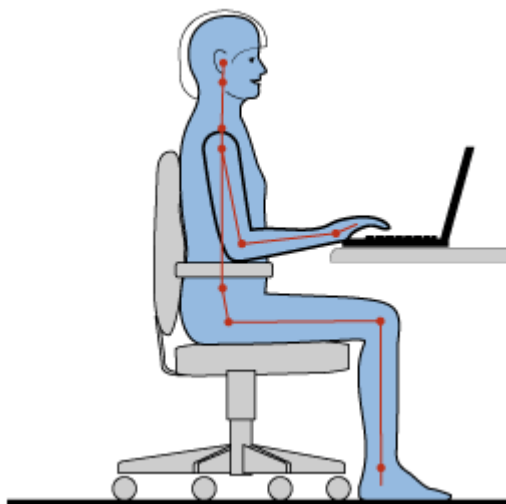

**General posture:** Make minor modifications in your working posture to deter the onset of discomfort caused by long periods of working in the same position. Frequent, short breaks from your work also help to prevent minor discomfort associated with your working posture.

**Display:** Position the display to maintain a comfortable viewing distance of 510-760 mm (20-30 inches). Avoid glare or reflections on the display from overhead lighting or outside sources of light. Keep the display screen clean and set the brightness to levels that enable you to see the screen clearly. Press F5 or F6 to adjust display brightness.

**Head position:** Keep your head and neck in a comfortable and neutral (vertical, or upright) position.

**Chair:** Use a chair that gives you good back support and seat height adjustment. Use chair adjustments to best suit your desired posture.

**Arm and hand position:** If available, use chair arm rests or an area on your working surface to provide weight support for your arms. Keep your forearms, wrists, and hands in a relaxed and neutral (horizontal) position. Type with a soft touch without pounding the keys.

**Leg position:** Keep your thighs parallel to the floor and your feet flat on the floor or on a footrest.

### ***What if you are traveling?***

It might not be possible to observe the best ergonomic practices when you are using your computer while on the move or in a casual setting. Regardless of the setting, try to observe as many of these tips as possible. Sitting properly and using adequate lighting, for example, will help you maintain desirable levels of comfort and performance.

### ***Questions about vision?***

The visual display screens of ThinkPad notebook computers are designed to meet the highest standards and to provide you with clear, crisp images and large, bright displays that are easy to see, yet easy on the eyes. Of course, any concentrated and sustained visual activity can be tiring. If you have questions on eye fatigue or visual discomfort, consult a vision care specialist for advice.

## **Comfort**

Observe the following guidelines to achieve greater comfort and improve performance.

**Active sitting and rest breaks:** The longer you sit and work with your computer, the more important it is to observe your working posture. Follow “Ergonomic information” on page 43 and practice “active sitting” to avoid discomfort associated with your working postures. Making minor voluntary postural changes and taking short frequent work breaks are the key ingredients for healthy computing. Your computer is light and mobile; you can easily reposition your working surface to accommodate many posture modifications.

**Work area setup options:** Familiarize yourself with all of your office furniture so that you know how to adjust your work surface, seat, and other work tools to accommodate your preferences for comfort. If your work area is not in an office setting, be sure to take special note of employing active sitting and taking work breaks. Many ThinkPad product solutions are available to help you modify and expand your computer to best suit your needs. You can find some of these options at <http://www.lenovo.com/accessories/services/index.html>. Explore your options for docking solutions and external products that provide the adjustability and features that you want.

## **Accessibility information**

Lenovo is committed to providing people with disabilities greater access to information and technology. As a result, the following information provides ways to help users that have hearing, vision, and mobility limitations get the most out of their computer experience.

Assistive technologies enable users to access information in the most appropriate way. Some of these technologies are already provided in your operating system. Others can be purchased through vendors, or accessed through the World Wide Web <http://www.lenovo.com/healthycomputing>.

## Assistive technologies

Some accessibility technologies are available through the Accessibility Options program. Depending on your operating system, the number of accessibility options available varies. In general, accessibility options enhance the way users with hearing, vision, or mobility limitations navigate and use their computer. For example, some users might not have the fine motor skills required to use a mouse or select key combinations. Other users might require larger fonts or high-contrast display modes. In some cases, magnifiers and built-in speech synthesizers are available. For detailed information about each of these features, consult the Microsoft help information system.

To use the Accessibility Options program, open Control Panel and click **Ease of Access → Ease of Access Center**.

## Screen-reader technologies

Screen-reader technologies are primarily focused on software program interfaces, help information systems, and a variety of online documents. However, in the case where a screen reader cannot read documents, the document must first go through a conversion process. One solution converts Adobe PDF files into a format that is read by the screen-reader programs. This solution is a Web-based service provided by Adobe Systems Incorporated. Through <http://access.adobe.com>, Adobe PDF documents can be converted to HTML or plain text in many languages. One conversion option converts PDF documents on the Internet. A second option enables users to submit the URL of an Adobe PDF file through e-mail to convert it to HTML or ASCII text. Adobe PDF files on a local hard disk drive, local CD-ROM, or LAN also can be converted by attaching the Adobe PDF file to an e-mail message.

---

## Traveling with your computer

This topic provides information to help you work with your computer when you are traveling.

### Travel tips

Use the following travel tips to travel more confidently and efficiently with your computer.

- Although it is safe to allow your computer to go through the x-ray machines at airport security stations, it is important to keep your eyes on the computer at all times to prevent theft.
- Consider bringing an electrical adapter for use in an airplane or automobile.
- If you carry an ac power adapter, detach the ac cord from it to avoid damaging the cord.

### Travel tips on airplanes

If you carry your computer into an airplane, take note of the following tips:

- If you intend to use your computer or wireless services (such as Internet and Bluetooth), check with the airline for restrictions and availability of services before boarding the airplane. If there are restrictions on the use of computers with wireless features on the airplane, you must abide by those restrictions. If necessary, disable wireless features before boarding.
- Be careful about the seat in front of you on airplanes. Angle your computer display so that it does not get caught when the person in front of you leans back.
- When taking off, remember to turn off your computer or put it into hibernation mode.

## Travel accessories

The following is a checklist of items to consider packing when you are going to travel:

- ThinkPad ac power adapter
- Mini DisplayPort to HDMI adapter
- External mouse, if you are accustomed to using one
- Ethernet cable
- A quality carrying case that provides adequate cushion and protection
- External storage device

If you are traveling to another country, you might want to consider an ac power adapter for the country to which you are traveling.

To purchase travel accessories, go to <http://www.lenovo.com/accessories>.

---

## Chapter 4. Security

This chapter provides information about how to protect your computer from theft and unauthorized use.

- “Using passwords” on page 47
- “Hard disk security” on page 51
- “Setting the security chip” on page 52
- “Using the fingerprint reader” on page 53
- “Notice on deleting data from your hard disk drive or solid-state drive” on page 56
- “Using firewalls” on page 57
- “Protecting data against viruses” on page 57

---

### Using passwords

You can help prevent your computer from unauthorized use by using passwords. Once you set a password, a prompt is displayed on the screen each time you turn on the computer. Enter your password at the prompt. You cannot use the computer unless you type the correct password.

If you have set a power-on password, a supervisor password, or a hard disk password, it unlocks automatically when the computer resumes from sleep mode.

**Note:** If a Windows password has been set, you will be prompted to enter it.

### Typing passwords



When this icon is displayed, type a power-on password or a supervisor password.



When this icon is displayed, type a user hard disk password. To type a master hard disk password, press F1. When the icon changes to , type the master hard disk password



**Note:** To return to the icon , press F1 again.

### Power-on password

You can set a power-on password to help protect your computer against access by unauthorized users.

If you set a power-on password, the password prompt is displayed on the screen whenever you turn on the computer. You must enter the correct password to start using the computer.

#### Setting, changing, or removing a power-on password

Before you start, print these instructions.

To set, change, or remove a power-on password, do the following:

1. Restart the computer. When the logo screen is displayed, press F1 to start the ThinkPad Setup program.
2. Select **Security** → **Password** → **Power-on Password** by using the directional keys.

3. Depending on your need, do one of the following:
  - To set a password, do the following:
    - a. In the **Enter New Password** field, type a desired password and press Enter.
    - b. In the **Confirm New Password** field, retype the password and press Enter.
  - To change a password, do the following:
    - a. In the **Enter Current Password** field, type the current power-on password and press Enter.
    - b. In the **Enter New Password** field, type the new power-on password and press Enter; then retype the password in the **Confirm New Password** field and Enter.
  - To remove a password, do the following:
    - a. In the **Enter Current Password** field, type the current power-on password and press Enter.
    - b. Leave the **Enter New Password** and **Confirm New Password** fields blank. Press Enter twice.
4. A Setup Notice window is displayed. Press Enter to continue.
5. Press F10. A Setup Confirmation window is displayed. Select **Yes** to save the configuration changes and exit the ThinkPad Setup program.

**Note:** You might want to record your password and store it in a safe place. Otherwise, if you forget the password, you have to take your computer to a Lenovo reseller or a marketing representative to have the password canceled.

## Supervisor password

The supervisor password protects the system information stored in the ThinkPad Setup program. If you have set a supervisor password, no one can change the configuration of the computer without the password. It provides the following security features:

- If only a supervisor password is set, a password prompt is displayed when you try to start the ThinkPad Setup program. Unauthorized users cannot access the ThinkPad Setup program without the password.
- The system administrator can use the supervisor password to access a computer even if the user of that computer has set a power-on password. The supervisor password overrides the power-on password.
- If both a supervisor password and a power-on password are set, you can do the following only if you have the supervisor password:
  - Changing or deleting the power-on password
  - Changing or deleting the supervisor password
  - Changing date and time
  - Specifying the minimum length for power-on password and hard disk password
  - Changing the setting for the security chip
  - Erasing the fingerprint data
  - Enabling or disabling the following features:
    - Wake on LAN and Flash over LAN
    - Lock UEFI BIOS Settings
    - Password at unattended boot
    - Boot Device List F12 Option
    - Boot Order Lock
    - Flash BIOS Updating by End-Users
    - Internal network device



- Internal wireless device
- Internal Bluetooth device
- Internal Network Option ROM
- Internal wireless WAN device
- Security mode
- Fingerprint reader priority

#### Notes:

- The system administrator can set the same supervisor password on many ThinkPad notebook computers to make administration easier.
- When **Lock UEFI BIOS Settings** option is enabled, all BIOS settings cannot be changed. To change the settings, a supervisor password is required.

#### Setting, changing, or removing a supervisor password

Before you start, print these instructions.

Only a system administrator can set, change, or remove a supervisor password. To set, change, or remove a supervisor password, do the following:

1. Restart the computer. When the logo screen is displayed, press F1 to start the ThinkPad Setup program.
2. Select **Security** → **Password** → **Supervisor Password** by using the directional keys.
3. Depending on your needs, do one of the following:
  - To set a password, do the following:
    - a. In the **Enter New Password** field, type a desired password and press Enter.
    - b. In the **Confirm New Password** field, retype the password and press Enter.
  - To change a password, do the following:
    - a. In the **Enter Current Password** field, type the current supervisor password and press Enter.
    - b. In the **Enter New Password** field, type the new supervisor password and press Enter; then retype the password in the **Confirm New Password** field and press Enter.
  - To remove a password, do the following:
    - a. In the **Enter Current Password** field, type the current supervisor password and press Enter.
    - b. Leave the **Enter New Password** and **Confirm New Password** fields blank. Press Enter twice.
4. A Setup Notice window is displayed. Press Enter to continue.
5. Press F10. A Setup Confirmation window is displayed. Select **Yes** to save the configuration changes and exit the ThinkPad Setup program.

**Note:** You might want to record your password and store it in a safe place. The next time you open the ThinkPad Setup program, you will be prompted to type your supervisor password to proceed. If you forget your supervisor password, Lenovo cannot reset your password. You must take your computer to a Lenovo reseller or a Lenovo marketing representative to have the system board replaced. Proof of purchase is required, and a fee will be charged for parts and service.

#### Hard disk passwords

The following two types of hard disk passwords can help protect the information stored on the hard disk drive:

- **User hard disk password**

If a user hard disk password has been set, but no master hard disk password has been, the user must enter the user hard disk password to access files and applications on the hard disk drive.

- **Master hard disk password**

The master hard disk password also requires a user hard disk password. The master hard disk password is usually set and used by a system administrator. It enables the administrator to access any hard disk drive in a system like a master key. The administrator sets the master password; then assigns a user password for each computer in the network. The user can then change the user password as desired, but the administrator still can get access by using the master password.

When a master hard disk password is set, only the administrator can remove the user hard disk password.

### **Setting a hard disk password**

Before you start, print these instructions.

To set a hard disk password, do the following:

1. Restart the computer. When the logo screen is displayed, press F1 to start the ThinkPad Setup program.
2. Select **Security → Password → Hard disk x Password** by using the directional keys.
3. A password window is displayed. You are prompted to select **User** or **User + Master**. Select **User** if you want to set only one hard disk password. Select **User + Master** if you want to set a user hard disk password and a master hard disk password, for example if you are an administrator or a supervisor.
  - If you select **User**, do the following:
    - a. When a window for typing the new password opens, type your new password in the **Enter New Password** field and press Enter.
    - b. In the **Confirm New Password** field, retype the password you just entered and press Enter.
  - If you select **User + Master**, do the following:
    - a. First, set a user hard disk password. When a message window prompts you to set the user hard disk password, press Enter to continue. Type your new user hard disk password in the **Enter New Password** field and press Enter. Retype the password in the **Confirm New Password** field and press Enter.
    - b. Then, set a master hard disk password. When a message window prompts you to set the master hard disk password, press Enter to continue. Type your new master hard disk password in the **Enter New Password** field and press Enter. Retype the password in the **Confirm New Password** field and press Enter.
4. A Setup Notice window is displayed. Press Enter to continue.
5. Press F10. A Setup Confirmation window is displayed. Select **Yes** to save the configuration changes and exit the ThinkPad Setup program.

The next time you turn on your computer, type the user or master hard disk password to start your computer and access the operating system.

### **Changing or removing a hard disk password**

To change or remove the hard disk password, do the following:

- If you are in **User + Master** hard disk mode, you can select either **User HDP** or **Master HDP** to change the password, depending on your needs.
  - If you select **User HDP** mode, follow the following steps to change the user hard disk password:
    1. Type the current user hard disk password in the **Enter Current Password** field and press Enter.
    2. Type the new password in the **Enter New Password** field and press Enter; then retype the password in the **Confirm New Password** field and press Enter.

3. A Setup Notice window is displayed. Press Enter again to continue. The user hard disk password is changed.

**Note:** The hard disk password cannot be removed in **User HDP** mode.

- If you select **Master HDP** mode, follow the following steps to change the master hard disk password:
  1. Type the current master hard disk password in the **Enter Current Password** field and press Enter.
  2. Type the new master hard disk password in the **Enter New Password** field and press Enter; then retype the new password you just entered in the **Confirm New Password** field and press Enter.
  3. A Setup Notice window is displayed. Press Enter to continue. The master hard disk password is changed.

**Note:** If you leave the **Enter New Password** and **Confirm New Password** fields blank and press Enter twice, both the user and master hard disk passwords are removed.

- If you are in **User** hard disk mode, follow the following steps to change the user hard disk password:
  1. Follow steps 1 through 7 in “Setting a hard disk password” on page 50, typing your password to start the ThinkPad Setup program.
  2. Type the current user hard disk password in the **Enter Current Password** field and press Enter.
  3. Type the new password in the **Enter New Password** field and press Enter; then retype the new password in the **Confirm New Password** field and press Enter.
  4. A Setup Notice window is displayed. Press Enter again to continue. The user hard disk password is changed.

**Note:** If you leave the **Enter New Password** and **Confirm New Password** fields blank and press Enter twice, the user hard disk password is removed.

### Tips on using the hard disk passwords

- You can set the minimum length of a hard disk password through the **Security** menu.
- If you set a hard disk password of over seven characters, the hard disk drive can be used only with a computer that can recognize a hard disk password of over seven characters. If you then install the hard disk drive in a computer that cannot recognize a hard disk password that contains more than seven characters, you cannot access the drive.
- Record your password and store it in a safe place. If you forget the user hard disk password, or both user and master hard disk passwords, Lenovo cannot reset your passwords or recover data from the hard disk drive. You must take your computer to a Lenovo reseller or a marketing representative to have the hard disk drive replaced. Proof of purchase is required, and a fee will be charged for parts and service.

---

## Hard disk security

To protect passwords from unauthorized security attacks, refer to the following tips to maximize security:

- Set a power-on password as well as a hard disk password for your internal solid-state drive or hard disk drive. Refer to the procedures in “Power-on password” on page 47 and “Hard disk passwords” on page 49. For security, a longer password is recommended.
- To provide reliable security for the UEFI BIOS, use the security chip and a security application with a Trusted Platform Module management feature. Refer to “Setting the security chip” on page 52.

**Note:** The Windows 7 and Windows 8 operating systems support the TPM management feature.

- If a Disk Encryption hard disk drive and Encryption solid-state drive is installed in your computer, be sure to protect the contents of your computer memory from unauthorized accesses by use of drive encryption software, such as Microsoft Windows BitLocker® Drive Encryption, which is supported in the Ultimate and

Enterprise editions of the Windows 7 operating system and Windows 8 operating system. See “Using Windows BitLocker Drive Encryption” on page 52.

- Before you dispose of, sell, or hand over your computer, delete data stored on it. For more information, refer to “Notice on deleting data from your hard disk drive or solid-state drive” on page 56.

The hard disk drive built into your computer can be protected by the UEFI BIOS.

### Using Windows BitLocker Drive Encryption

To help protect your computer against unauthorized access, use the drive encryption software, such as Windows BitLocker Drive Encryption.

Windows BitLocker Drive Encryption is an integral security feature of Windows 7 and Windows 8 operating systems. It is supported in the Ultimate and Enterprise editions of the Windows 7 and Professional and Enterprise editions of the Windows 8 operating system. It can help you protect the operating system and data stored on your computer, even if your computer is lost or stolen. BitLocker works by encrypting all user and system files, including the swap and hibernation files.

BitLocker uses a Trusted Platform Module to provide enhanced protection for your data and to ensure early boot component integrity. A compatible TPM is defined as a V1.2 TPM.

To check the BitLocker status, go to Control Panel, and click **System and Security** → **BitLocker Drive Encryption**.

For more information about Windows BitLocker Drive Encryption, see the help information system of the Windows operating system, or search for “Microsoft Windows BitLocker Drive Encryption Step-by-Step Guide” on the Microsoft Web site.

### Disk Encryption hard disk drive and Encryption solid-state drive

Some models contain the Disk Encryption hard disk drive or Encryption solid-state drive. This feature helps to protect your computer against security attacks on media, NAND flash, or device controllers by use of a hardware encryption chip. For the efficient use of the encryption feature, set a hard disk password for the internal storage device.

---

## Setting the security chip

Strict security requirements are imposed on network client computers that transfer confidential information electronically. Depending on the options you ordered, your computer might have an embedded security chip, a cryptographic microprocessor. With the security chip and Client Security Solution, you can do the following:

- Protect your data and system
- Strengthen access controls
- Secure communications

### Setting the security chip

The choices offered on the **Security Chip** submenu under the **Security** menu of ThinkPad Setup are as follows:

- **Security Chip Selection:** Select Discrete TPM or Intel PTT.
- **Security Chip:** Activate, inactivate, or disable the security chip.
- **Security Reporting Options:** Enable or disable each security reporting option.
- **Clear Security Chip:** Clear the encryption key.

Before you start, print these instructions.

To set an item on the **Security Chip** submenu, do the following:

1. Restart the computer. When the logo screen is displayed, press F1 to start the ThinkPad Setup program.
2. Select **Security** → **Security Chip** by using the directional keys.
3. Press Enter. The **Security Chip** submenu opens.
4. Move to an item you want to set by using the directional keys. When the item is highlighted, press Enter.
5. Set other items that you want to set.
6. Press F10. A Setup Confirmation window is displayed. Select **Yes** to save the configuration changes and exit the ThinkPad Setup program..

To set the security chip, you have to start Client Security Solution, and follow the instructions on the screen.

**Note:** If Client Security Solution is not preinstalled on your computer, download and install it from <http://www.lenovo.com/support>. Then follow the instructions on the screen.

### Tips on using the security chip

- Ensure that the supervisor password has been set in ThinkPad Setup. Otherwise anyone can change the settings for the security chip.
- If you are using Client Security Solution, handle the security chip by doing the following:
  - Do not clear the security chip. If you do, the functions assigned to the keys will be erased.
  - Do not disable the security chip. If you do, Client Security Solution will not work.
- If the security chip is removed or replaced, or a new one has been added, the computer will not start. You will hear four cycles of four beeps each, or you will see error message 0176 or 0192.
- If the security chip is inactive or disabled, the **Clear Security Chip** option will not be displayed.
- When you clear the security chip, turn off your computer and then turn it on again after you set the security chip to **Active**. Otherwise, the **Clear Security Chip** option is not displayed.

---

## Using the fingerprint reader

Depending on the model, your computer might have a fingerprint reader. Fingerprint authentication can replace your passwords, such as the Windows password, power-on password, and hard disk password. In this way, you can log on to your computer simply and securely.

To enable fingerprint authentication, enroll your fingerprints first. During the enrollment, the fingerprints are associated with the Windows password automatically. To associate your fingerprints with your power-on password and hard disk password, manually create a connection.

### Enrolling your fingerprints

To enroll your fingerprints, do the following:

1. Start the Fingerprint Manager Pro program. For instructions on how to start the Fingerprint Manager Pro program, see “Lenovo programs” on page 14.
2. Enter the Windows password as required.
3. Click the icon for the finger that you want to enroll, and constantly swipe your corresponding finger across the fingerprint reader until the enrollment completes. For more information, see “Swiping your finger over the fingerprint reader” on page 54.
4. Click **Finish**. Your fingerprint is enrolled successfully.

**Note:** It is recommended that you enroll more than one fingerprint in case of any injuries to your fingers.

### Swiping your finger over the fingerprint reader

To swipe your finger over the fingerprint reader, do the following:

1. Place the top joint of your finger on the sensor.



2. Apply light pressure and swipe your finger toward you across the reader in one smooth motion. Do not lift your finger when you are swiping it.



## Indicator behavior of the fingerprint reader



Indicator behavior	Description
Green	The fingerprint reader is ready for swiping.
Amber	The fingerprint cannot be authenticated.

### Associating your fingerprints with your power-on password and hard disk password

To associate your fingerprints with your power-on password and hard disk password, do the following:

1. Turn off and then turn on the computer.
2. When prompted, swipe your finger over the fingerprint reader.
3. Enter your power-on password, hard disk password, or both as required. The connection is created.

When you start the computer again, you can use your fingerprints to log on to the computer with no need to enter your Windows password, power-on password, and hard disk password.

**Attention:** If you always use your fingerprint to log on to the computer, you might forget your passwords. Write down your passwords, and keep them in a safe place. If you forget your power-on password, you must take your computer to a Lenovo authorized servicer or a marketing representative to have the password canceled. If you forget your hard disk password, Lenovo cannot reset your password or recover data from the hard disk drive. You must take your computer to a Lenovo authorized servicer or a marketing representative to have the hard disk drive replaced. Proof of purchase is required, and a fee will be charged for parts and service.

### Setting the fingerprint reader

You can set the fingerprint reader in the Fingerprint Manager Pro program. You also can change some advanced settings in the ThinkPad Setup program.

To change the settings in the Fingerprint Manager Pro program, click **Settings** on the program main interface. To change the settings in the ThinkPad Setup program, see “Using the ThinkPad Setup program” on page 101.

You can set the following configurations in the ThinkPad Setup program:

- **Predesktop Authentication:** Enables or disables fingerprint authentication before the operating system is loaded.

- **Reader Priority:** Defines the priority for the fingerprint readers if an external fingerprint reader is attached.
- **Security Mode:** Specifies the settings of the security mode.
- **Password Authentication:** Enables or disables the password authentication.

**Note:** This item is displayed only if **High security** mode is enabled.

- **Reset Fingerprint Data:** Select this item to erase all of the fingerprint data stored in either the internal or external fingerprint reader.

### **Maintaining the fingerprint reader**

The following actions could damage the fingerprint reader or cause it not to work properly:

- Scratching the surface of the reader with a hard, pointed object.
- Scraping the surface of the reader with your fingernail or anything hard.
- Using or touching the reader with a dirty finger.

If you notice any of the following conditions, gently clean the surface of the reader with a dry, soft, lint-free cloth:

- The surface of the reader is dirty or stained.
- The surface of the reader is wet.
- The reader often fails to enroll or authenticate your fingerprint.

If your finger has any of the following conditions, you might not be able to register or authenticate it:

- Your finger is wrinkled.
- Your finger is rough, dry, or injured.
- Your finger is dry.
- Your finger is stained with dirt, mud, or oil.
- The surface of your finger is different from when you enrolled your fingerprint.
- Your finger is wet.
- A finger is used that has not been enrolled.

To improve the situation, try the following:

- Clean or wipe your hands to remove any excess dirt or moisture from the fingers.
- Enroll and use a different finger for authentication.
- If your hands are dry, apply lotion to them.

For more information on how to use the fingerprint reader, refer to the help system of the Fingerprint Manager Pro program.

---

## **Notice on deleting data from your hard disk drive or solid-state drive**

Some of the data stored on the hard disk drive or solid-state drive might be sensitive. Handing your computer over to someone else without deleting the loaded software, such as operating systems and application software, might even violate license agreements. Be sure to delete data stored on the hard disk drive or solid-state drive before you dispose of, sell, or hand over your computer.

You can use the following methods to delete data from the hard disk drive or solid-state drive:

- Move the data to the Recycle Bin, and then empty the Recycle Bin.



- Delete the data.
- Format your hard disk drive or solid-state drive, using the software for initializing it.
- Use the recovery program provided by Lenovo to bring the hard disk drive or solid-state drive back to the factory default settings.

These operations, however, only change the file location of the data; they do not delete the data itself. In other words, the data retrieval processing is disabled under an operating system such as Windows. The data is still there, even though it seems to be lost. Thus, it is sometimes possible to read the data by use of special software for data recovery. There is a risk that people of bad faith might read and misuse the critical data on hard disk drives or solid-state drives for unexpected purposes.

To prevent leakage of data, it is important that you delete all the data from the hard disk drive when you dispose of, sell, or hand over your computer. You can destroy the data physically by smashing the hard disk drive with a hammer, or magnetically by means of strong magnetic power, thus making the data unreadable. But it is recommended that you use the software (payware) or service (pay service) developed for that purpose. The process might take several hours.

For disposing of data on the hard disk drive or solid-state drive, Lenovo provides the Secure Data Disposal™ tool. Go to <http://www.lenovo.com/support> to download the tool.

If an Encryption solid-state drive or a Disk Encryption hard disk drive is supported and installed in your computer, you can logically dispose of all the data on the drive in a short time by erasing the cryptographic key. The data encrypted with the old key is not physically erased but remains on the drive; however, it cannot be decrypted without the old key. This feature is enabled by ThinkPad Setup Menu Extension Utility and is available as a menu item in ThinkPad Setup.

---

## Using firewalls

If your system is preinstalled with a firewall program, it protects against computer Internet security threats, unauthorized accesses, intrusions, and Internet attacks. It also protects your privacy.

For more information about how to use the firewall program, refer to the help information system that comes with the program.

---

## Protecting data against viruses

Your computer is preinstalled with an antivirus program so you can detect and eliminate viruses. The antivirus program is designed to help you detect and eliminate viruses.

Lenovo provides a full version of antivirus software on your computer with a free 30-day subscription. After 30 days, you must renew the license to continue receiving the antivirus software updates.

For more information about how to use your antivirus software, refer to the help information system of your antivirus software.



---

## Chapter 5. Recovery overview

This chapter provides information about the recovery solutions.

- “Recovery overview for the Windows 7 operating system” on page 59
- “Recovery overview for the Windows 8 operating system” on page 64

---

### Recovery overview for the Windows 7 operating system

This section provides information about the recovery solutions provided by Lenovo on the Windows 7 operating system.

#### Notes:

- There are a variety of methods to choose from when considering how to recover in the event of a software-related or hardware-related problem. Some methods vary depending on the type of your operating system.
- The product on the recovery media might be used only for the following purposes:
  - Restore the product preinstalled on your computer
  - Reinstall the product
  - Modify the product using the Additional Files

To prevent potential performance risks or unexpected behavior that might be caused by the new hard disk drive technology, it is recommended that you use one of the following back-up software programs:

- ThinkVantage Rescue and Recovery version 4.3 or later
- Symantec Norton Ghost version 15 or later

To start the Symantec Norton Ghost program, do the following:

1. Click **Start** → **Run**. The Run window opens.
  2. Type `cmd` in the field. Then click **OK**.
  3. Type `ghost -align=1mb` and press Enter.
- Acronis True Image 2010 or later
  - Paragon Backup & Recovery 10 Suite or later, Paragon Backup & Recovery 10 Home or later

### Creating and using recovery media

You can use recovery media to restore the hard disk drive to the factory default settings. Recovery media are useful if you transfer the computer to another area, sell the computer, recycle the computer, or put the computer in an operational state after all other methods of recovery have failed. As a precautionary measure, it is important to create recovery media as early as possible.

**Note:** The recovery operations you can perform using recovery media vary depending on the operating system from which the recovery media were created. The recovery media might contain a boot medium and a data medium. Your Microsoft Windows license permits you to create only one data medium, so it is important that you store the recovery media in a safe place after you have made them.

#### Creating recovery media

This section provides instructions on how to create recovery media.

**Note:** On the Windows 7 operating system, you can create recovery media using discs or external USB storage devices.

To create recovery media on the Windows 7 operating system, click **Start → All Programs → Lenovo ThinkVantage Tools → Factory Recovery Disks**. Then, follow the instructions on the screen.

### Using recovery media

On the Windows 7 operating system, you can use recovery media to restore the computer to the factory default settings only. You can use recovery media to put the computer in an operational state after all other methods of recovery have failed.

**Attention:** When you use recovery media to restore the computer to the factory default settings, all the files currently on the hard disk drive will be deleted and replaced by the factory default settings.

To use recovery media on the Windows 7 operating system, do the following:

1. Depending on the type of your recovery media, connect the boot medium (memory key or other USB storage device) to the computer, or insert the boot disc into the optical drive.
2. Repeatedly press and release the F12 key when turning on the computer. When the Boot Menu window opens, release the F12 key.
3. Select the desired startup device and press Enter. The restore process begins.
4. Follow the instructions on the screen to complete the operation.

### Notes:

1. After restoring your computer to the factory default settings, you might have to reinstall device drivers for some devices. See “Reinstalling preinstalled programs and device drivers” on page 63.
2. Some computers come with Microsoft Office or Microsoft Works preinstalled. If you need to recover or reinstall your Microsoft Office or Microsoft Works programs, you must use the *Microsoft Office CD* or *Microsoft Works CD*. These discs are provided only with computers preinstalled with Microsoft Office or Microsoft Works.

## Performing backup and recovery operations

The Rescue and Recovery program enables you to back up all your hard disk drive contents including the operating system, data files, software programs, and personal settings. You can designate where the Rescue and Recovery program stores the backup:

- In a protected area of your hard disk drive
- On the secondary hard disk drive if a secondary hard disk drive is installed in your computer
- On an attached external USB hard disk drive
- On a network drive
- On recordable discs (a recordable optical drive is required for this option)

After you have backed up the contents on the hard disk drive, you can restore the complete contents of the hard disk drive, restore only the selected files, or restore only the Windows operating system and programs.

### Performing a backup operation

To perform a backup operation using the Rescue and Recovery program on the Windows 7 operating system, do the following:

1. From the Windows desktop, click **Start → All Programs → Lenovo ThinkVantage Tools → Enhanced Backup and Restore**. The Rescue and Recovery program opens.
2. In the Rescue and Recovery main window, click the **Launch advanced Rescue and Recovery** arrow.

3. Click **Back up your hard drive** and select backup operation options. Then, follow the instructions on the screen to complete the backup operation.

### Performing a recovery operation

To perform a recovery operation using the Rescue and Recovery program on the Windows 7 operating system, do the following:

1. From the Windows desktop, click **Start → All Programs → Lenovo ThinkVantage Tools → Enhanced Backup and Restore**. The Rescue and Recovery program opens.
2. In the Rescue and Recovery main window, click the **Launch advanced Rescue and Recovery** arrow.
3. Click the **Restore your system from a backup** icon.
4. Follow the instructions on the screen to complete the recovery operation.

For more information about performing a recovery operation from the Rescue and Recovery workspace, see “Using the Rescue and Recovery workspace” on page 61.

## Using the Rescue and Recovery workspace

The Rescue and Recovery workspace resides in a protected, hidden area of your hard disk drive that operates independently from the Windows operating system. It enables you to perform recovery operations even if you cannot start the Windows operating system. You can perform the following recovery operations from the Rescue and Recovery workspace:

- **Rescue files from your hard disk drive or from a backup**

The Rescue and Recovery workspace enables you to locate files on your hard disk drive and transfer them to a network drive or other recordable media, such as a USB device or a disc. This solution is available even if you did not back up your files or if changes were made to the files since your last backup operation. You also can rescue individual files from a Rescue and Recovery backup located on your local hard disk drive, a USB device, or a network drive.

- **Restore your hard disk drive from a Rescue and Recovery backup**

If you have backed up your hard disk drive using the Rescue and Recovery program, you can restore the hard disk drive from a Rescue and Recovery backup, even if you cannot start the Windows operating system.

- **Restore your hard disk drive to the factory default settings**

The Rescue and Recovery workspace enables you to restore the complete contents of your hard disk drive to the factory default settings. If you have multiple partitions on your hard disk drive, you have the option to restore the factory default settings to the C: partition and leave the other partitions intact. Because the Rescue and Recovery workspace operates independently from the Windows operating system, you can restore the factory default settings even if you cannot start the Windows operating system.

**Attention:** If you restore the hard disk drive from a Rescue and Recovery backup or restore the hard disk drive to the factory default settings, all files on the primary hard disk drive partition (usually drive C:) will be deleted in the recovery process. If possible, make copies of important files. If you are unable to start the Windows operating system, you can use the rescue files feature of the Rescue and Recovery workspace to copy files from your hard disk drive to other media.

To start the Rescue and Recovery workspace, do the following:

1. Make sure that the computer is turned off.
2. Repeatedly press and release the F11 key when turning on the computer. When you hear beeps or see a logo screen, release the F11 key.
3. If you have set a Rescue and Recovery password, type your password when prompted. The Rescue and Recovery workspace opens after a short delay.

**Note:** If the Rescue and Recovery workspace fails to open, see “Solving recovery problems” on page 64.

4. Do one of the following:

- To rescue files from your hard disk drive or from a backup, click **Rescue files** and follow the instructions on the screen.
- To restore your hard disk drive from a Rescue and Recovery backup or to restore your hard disk drive to the factory default settings, click **Restore your system** and follow the instructions on the screen.

For more information about the features of the Rescue and Recovery workspace, click **Help**.

**Notes:**

1. After restoring your hard disk drive to the factory default settings, you might have to reinstall device drivers for some devices. See “Reinstalling preinstalled programs and device drivers” on page 63.
2. Some computers come with Microsoft Office or Microsoft Works preinstalled. If you need to recover or reinstall your Microsoft Office or Microsoft Works programs, you must use the *Microsoft Office CD* or *Microsoft Works CD*. These discs are provided only with computers preinstalled with Microsoft Office or Microsoft Works.

## Creating and using a rescue medium

With a rescue medium, such as a disc or a USB hard disk drive, you can recover the computer from failures that prevent you from gaining access to the Rescue and Recovery workspace on your hard disk drive.

**Notes:**

1. The recovery operations you can perform using a rescue medium vary depending on the operating system.
2. The rescue disc can be started in all types of optical drives.

### Creating a rescue medium

To create a rescue medium on the Windows 7 operating system, do the following:

1. From the Windows desktop, click **Start → All Programs → Lenovo ThinkVantage Tools → Enhanced Backup and Restore**. The Rescue and Recovery program opens.
2. In the Rescue and Recovery main window, click the **Launch advanced Rescue and Recovery** arrow.
3. Click the **Create Rescue Media** icon. The Create Rescue and Recovery Media window opens.
4. In the **Rescue Media** area, select the type of the rescue medium you want to create. You can create a rescue medium using a disc, a USB hard disk drive, or a secondary internal hard disk drive.
5. Click **OK** and follow the instructions on the screen to create a rescue medium.

### Using a rescue medium

This section provides instructions on how to use the rescue medium you have created.

- If you have created a rescue medium using a disc, use the following instructions to use the rescue medium:
  1. Turn off your computer.
  2. Repeatedly press and release the F12 key when turning on the computer. When the Boot Menu window is displayed, release the F12 key.
  3. In the Boot Menu window, select the desired optical drive as the first boot device. Then, insert the rescue disc into the optical drive and press Enter. The rescue medium starts.
- If you have created a rescue medium using a USB hard disk drive, use the following instructions to use the rescue medium:
  1. Attach the USB hard disk drive to one of the USB connectors on your computer.

2. Repeatedly press and release the F12 key when turning on the computer. When the Boot Menu window opens, release the F12 key.
  3. In the Boot Menu window, select the USB hard disk drive as the first boot device and press Enter. The rescue medium starts.
- If you have created a rescue medium using the secondary internal hard disk drive, set the secondary internal hard disk drive as the first boot device in the startup device sequence to start the rescue medium.

When the rescue medium starts, the Rescue and Recovery workspace opens. The help information for each feature is available from the Rescue and Recovery workspace. Follow the instructions to complete the recovery process.

## Reinstalling preinstalled programs and device drivers

Your computer has provisions that enable you to reinstall selected factory-installed programs and device drivers.

### Reinstalling preinstalled programs

To reinstall selected programs, do the following:

1. Turn on your computer.
2. Go to the C:\SWT00LS directory.
3. Open the APPS folder. The folder contains several subfolders named for the various preinstalled applications.
4. Open the subfolder for the program you are reinstalling.
5. Double-click **Setup**, and then follow the on-screen steps to reinstall the program.

### Reinstalling preinstalled device drivers

**Attention:** When you reinstall device drivers, you are changing the current configuration of your computer. Reinstall device drivers only when it is necessary to correct a problem with your computer.

To reinstall a device driver for a factory-installed device, do the following:

1. Turn on your computer.
2. Go to the C:\SWT00LS directory.
3. Open the DRIVERS folder. The folder contains several subfolders named for the various devices installed in your computer (for example, AUDIO and VIDEO).
4. Open the subfolder for the device.
5. Reinstall the device driver by one of the following methods:
  - In the subfolder for the device, look for a text file (a file with the extension .txt). The text file contains information on how to reinstall that device driver.
  - If the subfolder for the device contains a file of setup information (a file with the extension .inf), you can use the Add New Hardware program (in the Windows Control Panel) to reinstall the device driver. Not all device drivers can be reinstalled by use of this program. In the Add New Hardware program, when prompted for the device driver you want to install, click **Have Disk** and **Browse**. Then select the device driver file from the device subfolder.
  - In the subfolder for the device, look for the executable file (a file with the extension .exe). Double-click the file, and follow the instructions on the screen.

**Attention:** If you need updated device drivers for your computer, do not download them from the Windows Update Web site. Obtain them from Lenovo. For more information, see “Making sure device drivers are current” on page 118.

## Solving recovery problems

If you are unable to access the Rescue and Recovery workspace or the Windows environment, do one of the following:

- Use a rescue medium to start the Rescue and Recovery workspace. See “Creating and using a rescue medium” on page 62.
- Use recovery media if all other methods of recovery have failed and you need to restore the hard disk drive to the factory default settings. See “Performing backup and recovery operations” on page 60.

**Note:** If you are unable to access the Rescue and Recovery workspace or the Windows environment from a rescue medium or recovery media, you might not have the rescue device (an internal hard disk drive, a disc, a USB hard disk drive, or other external devices) set as the first boot device in the startup device sequence. You must first make sure that your rescue device is set as the first boot device in the startup device sequence in the Setup Utility program. See “Startup menu” on page 111 for detailed information about temporarily or permanently changing the startup device sequence. For more information about the Setup Utility program, see “Using the ThinkPad Setup program” on page 101.

It is important to create a rescue medium and a set of recovery media as early as possible and store them in a safe place for future use.

---

## Recovery overview for the Windows 8 operating system

This section provides information about the recovery solutions for the Windows 8 operating system.

A Windows recovery image is preinstalled in the recovery partition on your computer. The Windows recovery image enables you to refresh your computer, or reset your computer to the factory default settings.

You can create recovery media as backups or replacement for the Windows recovery image. With the recovery media, you can troubleshoot and fix the problems on your computer even if you cannot start the Windows 8 operating system. It is recommended that you create recovery media as early as possible. For more information, see “Creating and using recovery media” on page 65.

## Refreshing your computer

If your computer does not perform well and the problem might be caused by a recently installed program, you can refresh your computer without losing your personal files or changing your settings.

**Attention:** If you refresh your computer, the programs that came with your computer and the programs that you installed from Windows Store will be reinstalled, but all other programs will be removed.

To refresh your computer, do the following:

1. Move your cursor to the top-right or bottom-right corner of the screen to display the charms. Click **Settings → Change PC settings → General**.
2. In the **Refresh your PC without affecting your files** section, click **Get started**.
3. Follow the instructions on the screen to refresh your computer.

## Resetting your computer to the factory default settings

If you want to recycle your computer or just start over, you can reset your computer to the factory default settings. Resetting the computer will reinstall the operating system, reinstall all the programs that came with your computer, and reset all the settings to the factory default settings.

**Attention:** If you reset the computer to the factory default settings, all your personal files and settings will be deleted. To avoid data loss, make a backup copy of all the data that you want to keep.



To reset your computer to the factory default settings, do the following:

1. Move your cursor to the top-right or bottom-right corner of the screen to display the charms. Click **Settings → Change PC settings → General**.
2. In the **Remove everything and reinstall Windows** section, click **Get started**. Then click **Next** to confirm the operation.
3. Depending on your needs, do one of the following:
  - To perform a quick format, click **Just remove my files** to start the process. The process will take several minutes.
  - To perform a complete format, click **Fully clean the drive** to start the process. The process will take several hours.
4. Follow the instructions on the screen to reset your computer to the factory default settings.

## Using the advanced startup options

With the advanced startup options, you can change the firmware settings of the computer, change the startup settings of the Windows operating system, start the computer from an external device, or restore the Windows operating system from a system image.

To use the advanced startup options, do the following:

1. Move your cursor to the top-right or bottom-right corner of the screen to display the charms. Click **Settings → Change PC settings → General**.
2. In the **Advanced startup** section, click **Restart now → Troubleshoot → Advanced options**.
3. Select a desired startup option, then follow the instructions on the screen.

## Recovering your operating system if Windows 8 fails to start

The Windows recovery environment on your computer is capable of operating independently from the Windows 8 operating system. This enables you to recover or repair the operating system even if the Windows 8 operating system fails to start.

After two consecutive failed boot attempts, the Windows recovery environment starts automatically. Then you can choose repair and recovery options by following the instructions on the screen.

**Note:** Ensure that your computer is connected to ac power during the recovery process.

## Creating and using recovery media

You can create recovery media as backups for the Windows recovery environment and the Windows recovery image. If you cannot start the computer, you can use recovery media to troubleshoot and fix the problems on your computer.

It is recommended that you create recovery media as early as possible. Once you create recovery media, keep them in a safe place and do not use them to store other data.

### Creating recovery media

To create recovery media, you need a USB drive with at least 8 GB of storage. The required USB capacity depends on the size of the recovery image.

**Attention:** Creating recovery media will delete anything stored on the USB drive. To avoid data loss, make a backup copy of all the data that you want to keep.

To create recovery media, do the following:

**Note:** Ensure that your computer is connected to ac power.

1. Move your cursor to the top-right or bottom-right corner of the screen to display the charms, and click **Search**.
2. Type **recovery** in the **Search** field and click **Settings**. Then click **Create a recovery drive**.
3. Click **Yes** in the User Account Control window to allow the Recovery Media Creator program to start.
4. Ensure that you select the **Copy the recovery partition from the PC to the recovery drive** option. Then click **Next**.

**Important:** If you clear the **Copy the recovery partition from the PC to the recovery drive** option, you will create recovery media without the recovery partition content. You still can start the computer from the recovery media, but you might be unable to recover your computer if the recovery partition on your computer is damaged.

5. Connect a proper USB drive then click **Next**.
6. Click **Create** in the Recovery Drive window. The creation of the recovery media starts.
7. When the creation of the recovery media finishes, do one of the following:
  - To keep the recovery partition on your computer, click **Finish**.
  - To delete the recovery partition on your computer, click **Delete the recovery partition**.

**Attention:** If you delete the recovery partition on your computer, do keep the recovery media in a safe place. The Windows recovery image will not be stored in your computer anymore, and you will need the recovery media to refresh or reset your computer.

8. Remove the USB drive. The recovery media are created successfully.

### Using recovery media

If you cannot start your computer, or if you cannot start the Windows recovery image on your computer, use recovery media to recover your computer.

To use recovery media, do the following:

**Note:** Ensure that your computer is connected to ac power.

1. Turn on or restart the computer. Before the Windows operating system starts, repeatedly press F12. The Boot Menu window opens.
2. Select the recovery drive as the boot device.
3. Select a preferred language and then select a preferred keyboard layout.
4. Click **Troubleshoot** to display the optional recovery solutions.
5. Select a corresponding recovery solution according to your situation. For example, select **Reset your PC** if you want to reset your computer to the factory default settings.

For more information about the recovery solutions provided by the Windows 8 operating system, go to: <http://go.microsoft.com/fwlink/?LinkID=263800>

---

## Chapter 6. Replacing devices

This chapter contains the following items:

- “Static electricity prevention” on page 67
- “Disabling the built-in battery” on page 67
- “Installing or replacing the SIM card” on page 68
- “Replacing the external battery pack” on page 69
- “Replacing the base cover assembly” on page 71
- “Replacing the hard disk drive or solid-state drive” on page 72
- “Replacing a memory module” on page 74
- “Replacing the wireless LAN card” on page 75
- “Replacing the wireless WAN card” on page 78
- “Replacing the keyboard” on page 81
- “Replacing the RTC battery” on page 87

---

### Static electricity prevention

Static electricity, although harmless to you, can seriously damage computer components and options. Improper handling of static-sensitive parts can cause damage to the part. When you unpack an option or a CRU, do not open the static-protective package that contains the part until the instructions direct you to install the part.

When you handle options or CRUs, or perform any work inside the computer, take the following precautions to avoid static-electricity damage:

- Limit your movement. Movement can cause static electricity to build up around you.
- Always handle components carefully. Handle adapters, memory modules, and other circuit boards by the edges. Never touch exposed circuitry.
- Prevent others from touching components.
- When you install a static-sensitive option or CRU, touch the static-protective package that contains the part to a metal expansion-slot cover or other unpainted metal surface on the computer for at least two seconds. This reduces static electricity in the package and your body.
- When possible, remove the static-sensitive part from the static-protective package and install the part without setting it down. When this is not possible, place the static-protective package on a smooth, level surface and place the part on the package.
- Do not place the part on the computer cover or other metal surface.

---

### Disabling the built-in battery

Before replacing any devices, ensure that you have disabled the built-in battery by doing the following:

1. Disconnect the ac power adapter and all cables from the computer.
2. Restart the computer. When the ThinkPad logo is displayed, press F1 to start the ThinkPad Setup program.
3. Go to **Config → Power → Disable Built-in Battery**.
4. Press Enter. A Setup Confirmation window is displayed.

5. Click **Yes** in the Setup Confirmation window. The built-in battery is disabled and the computer turns off. Wait for a few minutes to let the computer cool.

The built-in battery will be automatically enabled again when the computer is connected to an ac power adapter.

---

## Installing or replacing the SIM card

Before you start, print these instructions.

SIM card is a small plastic card with Integrated Circuit (IC) chip mounted on one side of the card.

If your computer supports wireless WAN connections, your computer might require a SIM card to establish wireless WAN connections. Depending on the country or region of delivery, you might need to purchase a SIM card or a SIM card might already be installed in your computer or is part of the shipping contents that come with your computer.

To install or replace the SIM card, do the following:

1. Disable the built-in battery. See “Disabling the built-in battery” on page 67.
2. Locate the SIM card tray at the right side of the computer.
3. Insert a straightened paper clip into the hole in the SIM card tray **1**. The SIM card tray ejects **2**. Then, slide the SIM card tray out of the computer.

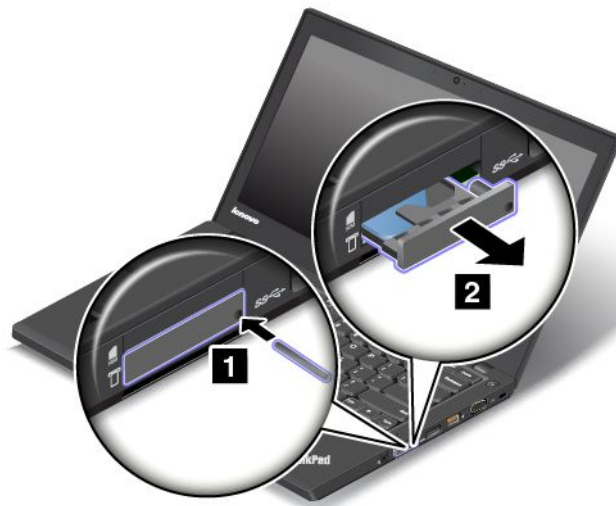

4. Gently take the SIM card out of the tray.

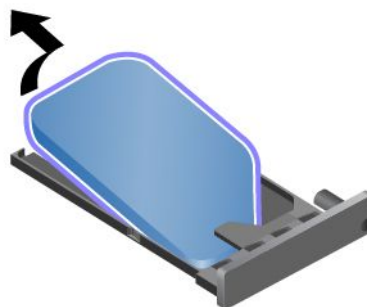

5. Install a new SIM card into the tray.

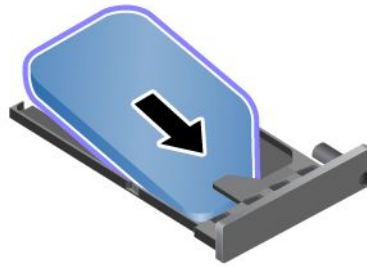

6. Insert the tray into the computer.



7. Reconnect the ac power adapter and all cables.

---

## Replacing the external battery pack

Before you start, print these instructions.

This system supports only batteries specially designed for this specific system and manufactured by Lenovo or an authorized builder. The system does not support unauthorized batteries or batteries designed for other systems. If an unauthorized battery or a battery designed for another system is installed, the system will not charge.

**Attention:** Lenovo has no responsibility for the performance or safety of unauthorized batteries, and provides no warranties for failures or damage arising out of their use.

**Note:** If an unauthorized battery is installed, the following message will be displayed:  
“The battery installed is not supported by this system and will not charge. Please replace the battery with the correct Lenovo battery for this system.”

## Prerequisites for the procedure



If the rechargeable battery pack is incorrectly replaced, there is danger of an explosion. The battery pack contains a small amount of harmful substances. To avoid possible injury:

- Replace only with a battery of the type recommended by Lenovo.
- Keep the battery pack away from fire.
- Do not expose it to excessive heat.
- Do not expose it to water or rain.
- Do not short-circuit it.
- Do not drop, crush, puncture, or subject to strong forces. Battery abuse or mishandling can cause the battery to overheat, which can cause gasses or flame to “vent” from the battery pack or RTC battery.

To replace the external battery pack, do the following:

1. Disable the built-in battery. See “Disabling the built-in battery” on page 67.
2. Close the computer display, and turn the computer over.
3. Unlock the battery latch **1** by sliding it to the unlocked position. Then slide the latch **2** to the unlocked position and hold it in the unlocked position, and then remove the battery pack **3**.

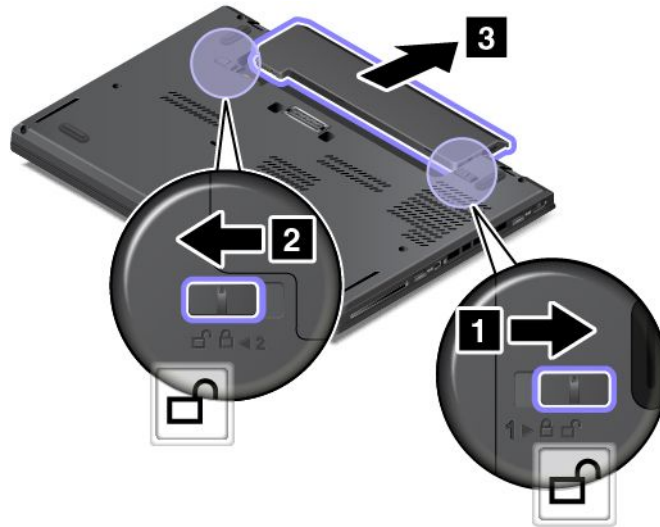

4. Insert a new battery pack until it clicks into place **1**, and then slide the battery latch to the locked position **2**.

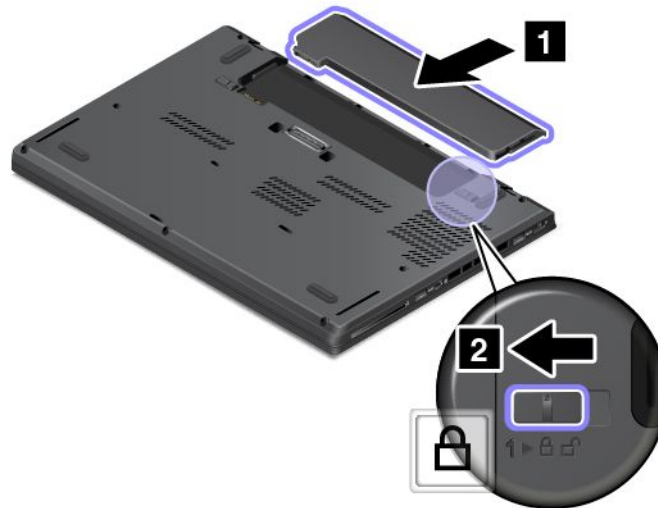

5. Turn the computer over again. Connect the ac power adapter and all cables to the computer.

---

## Replacing the base cover assembly

Before you start, print these instructions.

**Note:** Depending on the model, your computer might look slightly different from the illustrations in this topic.

To replace the base cover assembly, do the following:

1. Disable the built-in battery. See “Disabling the built-in battery” on page 67.
2. Close the computer display, and turn the computer over.
3. Remove the external battery pack. See “Replacing the external battery pack” on page 69.
4. Loosen the screws **1** that secure the base cover assembly. Then remove the base cover assembly **2**.

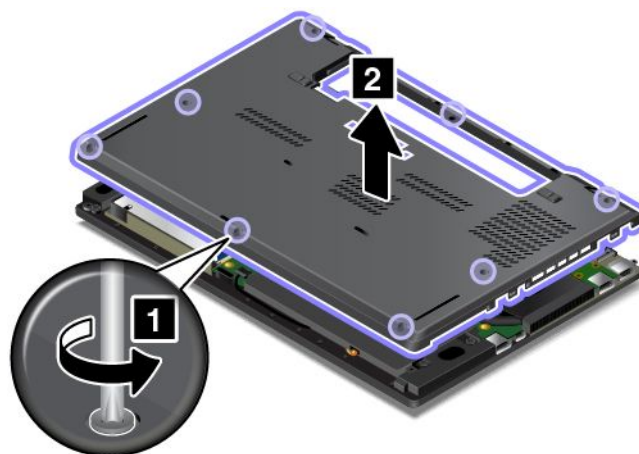

5. Reinstall the new base cover assembly **1** and tighten the screws **2**.

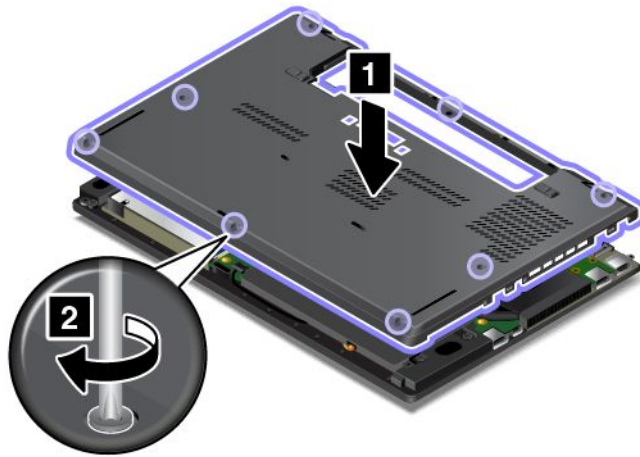

6. Reinstall the external battery pack and turn the computer over again. Connect the ac power adapter and all cables.

---

## Replacing the hard disk drive or solid-state drive

Before you start, print these instructions.

**Attention:** The hard disk drive or solid-state drive is very sensitive. Incorrect handling can cause damage and permanent loss of data. Observe the following guidelines:

- Replace the hard disk drive or solid-state drive only if you upgrade it or have it repaired. The connectors and slot of the hard disk drive or solid-state drive are not designed for frequent changes or replacement.
- Do not drop the hard disk or solid-state drive or subject it to physical shocks. Put the hard disk drive or solid-state drive on a material, such as soft cloth, that absorbs any physical shocks.
- Do not apply pressure to the cover of the hard disk drive or solid-state drive.
- Do not touch the connector.
- Before removing the hard disk drive or solid-state drive, make a backup copy of all the information on it, and then turn off the computer .
- Never remove the hard disk drive or solid-state drive while the computer is operating, in sleep mode, or in hibernation mode.

To replace the hard disk drive or solid-state drive, do the following:

1. Disable the built-in battery. See “Disabling the built-in battery” on page 67.
2. Close the computer display, and turn the computer over.
3. Remove the external battery pack. See “Replacing the external battery pack” on page 69.
4. Remove the base cover assembly. See “Replacing the base cover assembly” on page 71.



5. Remove the screw that secures the hard disk drive or solid-state drive.

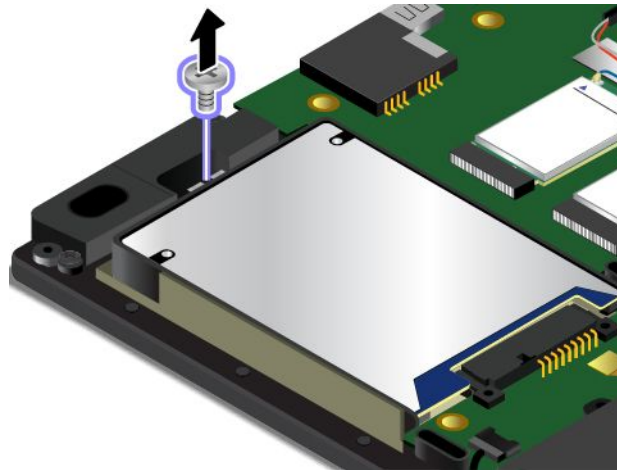

6. Remove the hard disk drive or solid-state drive with bracket.

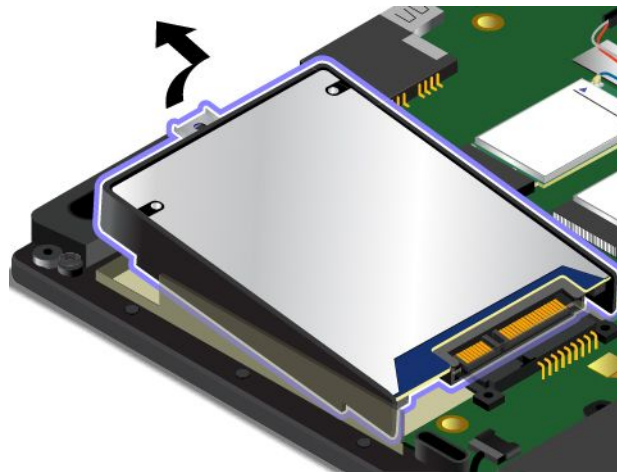

7. Detach the bracket from the hard disk drive or solid-state drive. Then attach the bracket to the new hard disk drive or solid-state drive.

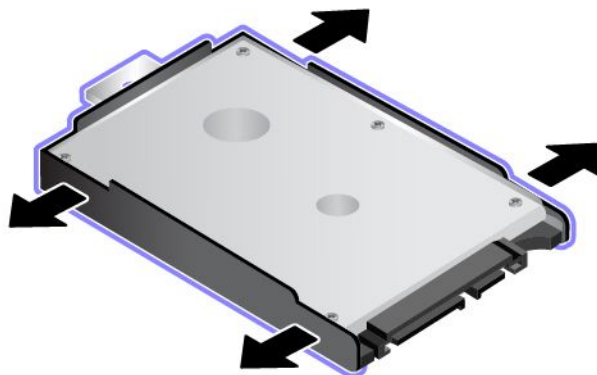

8. Install the new hard disk drive or solid-state drive with bracket.

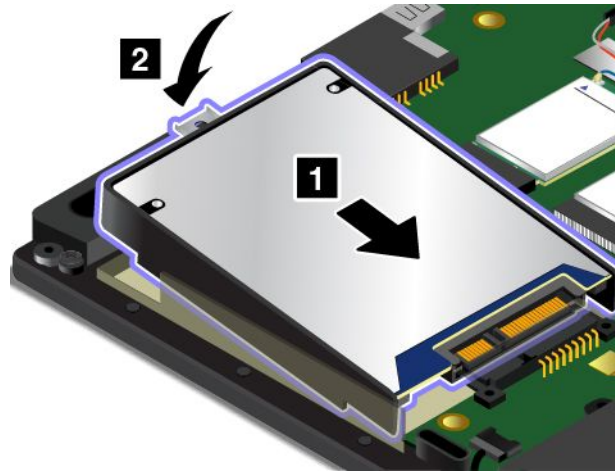

9. Install the screw to secure the hard disk drive or solid-state drive.

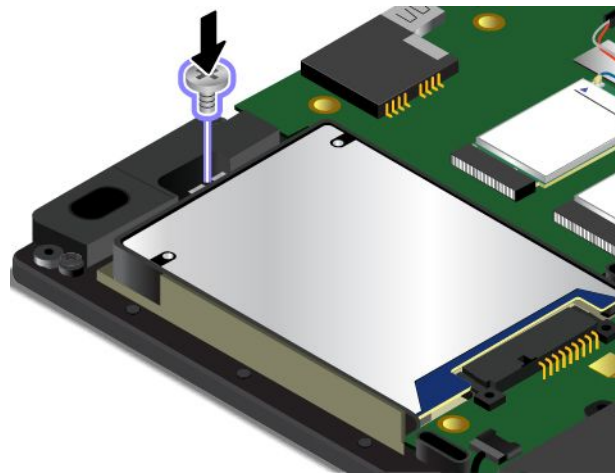

10. Reinstall the base cover assembly and the external battery pack.

11. Turn over the computer and connect the ac power adapter and all cables.

---

## Replacing a memory module

Before you start, print these instructions.

Increasing memory capacity is an effective way to make programs run faster. You can increase memory capacity by replacing or adding a memory module.

**Note:** The operating speed of the memory module has dependency on the system configuration. In some conditions, the memory module in your computer might not be able to operate at the maximum speed.

**Attention:** Before you start installing a memory module, touch a metal table or a grounded metal object. This action reduces any static electricity from your body. Static electricity could damage the memory module.

To replace a memory module, do the following:

1. Disable the built-in battery. See “Disabling the built-in battery” on page 67.
2. Close the computer display, and turn the computer over.
3. Remove the external battery pack. See “Replacing the external battery pack” on page 69.
4. Remove the base cover assembly. See “Replacing the base cover assembly” on page 71.

5. Open the latches on both sides of the slot at the same time **1**, and then remove the memory module **2**. Save the removed memory module for future use.

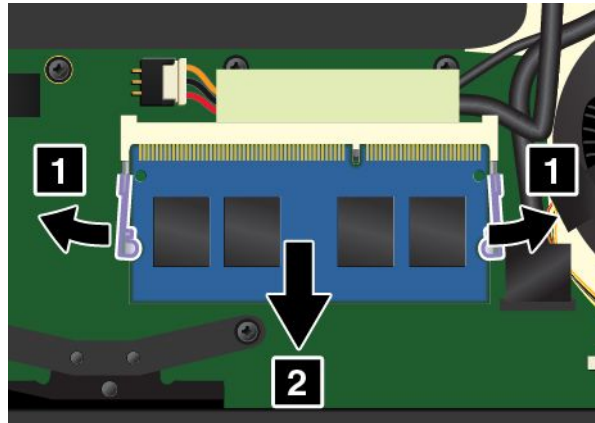

6. Place the notched end of the new memory module toward the contact edge side of the memory slot, and insert the memory module **1** into the slot at an angle of about 20 degrees. Pivot the memory module downward until it snaps into place **2**. Ensure that the memory module is firmly installed in the slot and cannot be moved easily.

**Attention:** Do not touch the contact edge of the memory module. Otherwise the memory module might be damaged.

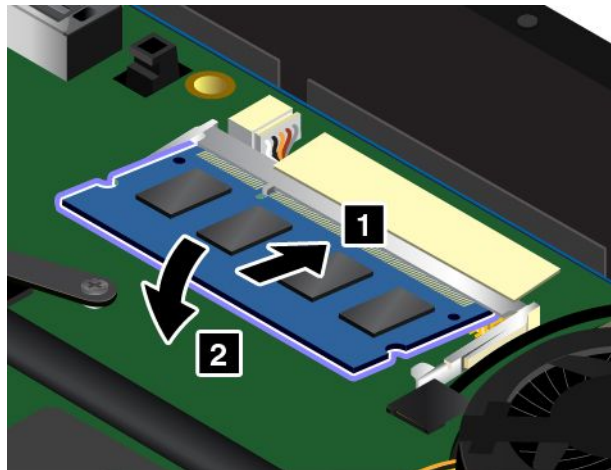

7. Reinstall the base cover assembly and the external battery pack.
8. Turn the computer over again. Connect the ac power adapter and all cables.

---

## Replacing the wireless LAN card

Before you start, print these instructions.



**During electrical storms, do not connect the cable to or disconnect it from the telephone outlet on the wall.**



**Electric current from power, telephone, and communication cables is hazardous. To avoid shock hazard, disconnect the cables before opening the cover of this slot.**

**Attention:** Before you start installing the wireless LAN card, touch a metal table or a grounded metal object. This action reduces any static electricity from your body. Static electricity could damage the card.

To replace the wireless LAN card, do the following:

1. Disable the built-in battery. See “Disabling the built-in battery” on page 67.
2. Close the computer display, and turn the computer over.
3. Remove the external battery pack. See “Replacing the external battery pack” on page 69.
4. Remove the base cover assembly. See “Replacing the base cover assembly” on page 71.
5. If a tool is provided with the new card to help you disconnect cables, use the tool to disconnect the cables from the old card. If no such a tool is provided, hold the cable connector with your fingers and gently disconnect each cable from the old card.

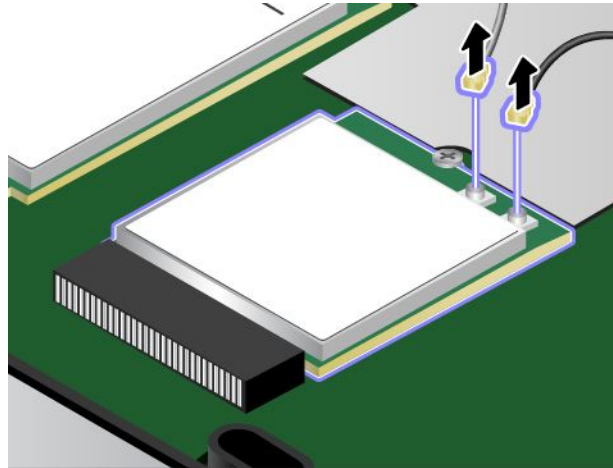

6. Remove the screw. The card is released from the secured position and pivots upward.

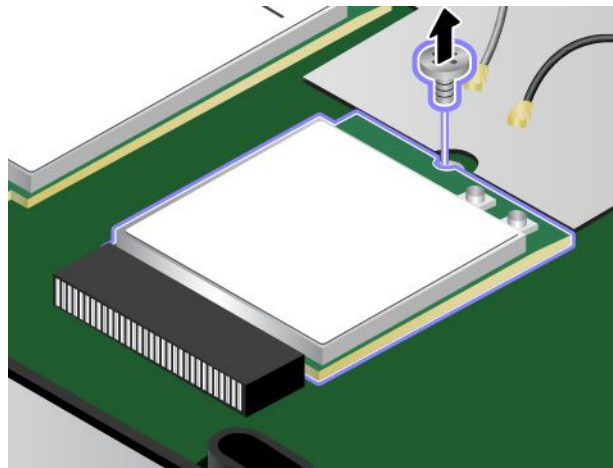

7. Carefully remove the wireless LAN card out of the slot.

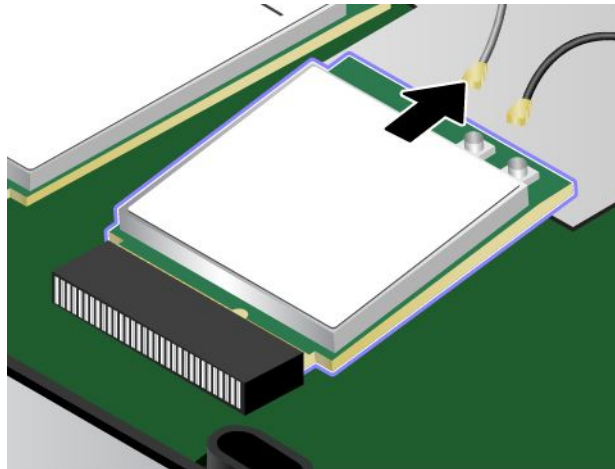

8. Align the notched edge of the new wireless LAN card with the key in the slot. Then carefully insert the card into the slot.

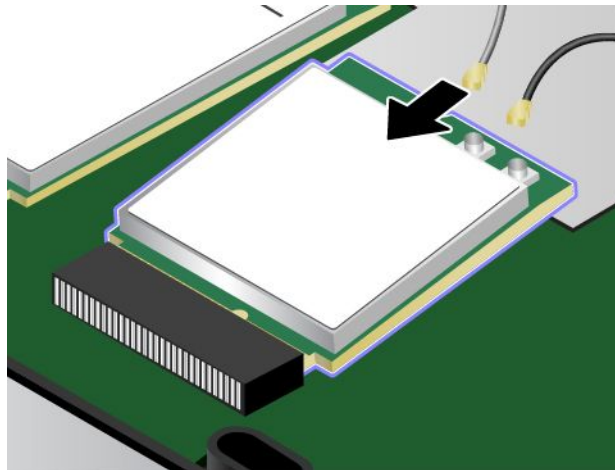

9. Pivot the new wireless LAN card downward **1**, and then install the screw to secure the card in place **2**.

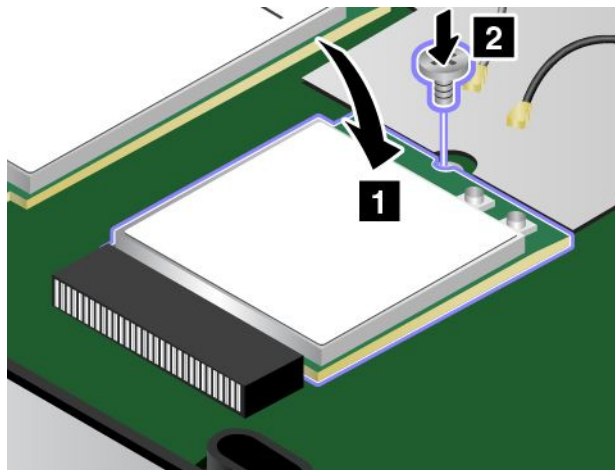

10. Connect the antenna cables to the new wireless LAN card. Ensure that you attach the gray cable to the main connector on the card, and the black cable to the auxiliary connector on the card.

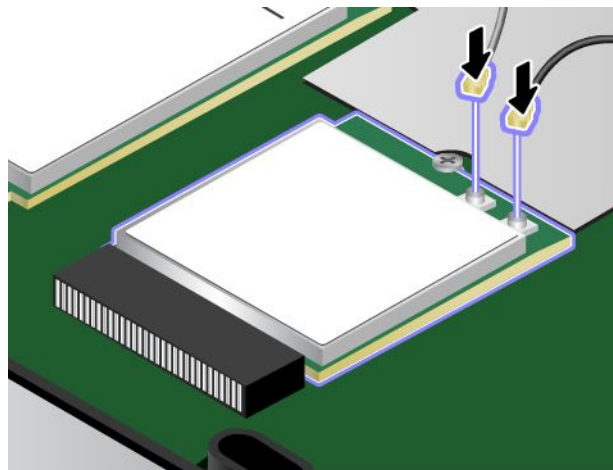

11. Reinstall the base cover assembly and the external battery pack.
12. Turn the computer over again. Connect the ac power adapter and all cables.

---

## Replacing the wireless WAN card

Before you start, print these instructions.



**During electrical storms, do not connect the cable to or disconnect it from the telephone outlet on the wall.**



**Electric current from power, telephone, and communication cables is hazardous. To avoid shock hazard, disconnect the cables before opening the cover of this slot.**

**Attention:** Before you start installing the wireless WAN card, touch a metal table or a grounded metal object. This action reduces any static electricity from your body. Static electricity could damage the card.

Some computers might come with the wireless WAN card. To replace the wireless WAN card, do the following:

1. Disable the built-in battery. See “Disabling the built-in battery” on page 67.
2. Close the computer display, and turn the computer over.
3. Remove the external battery pack. See “Replacing the external battery pack” on page 69.
4. Remove the base cover assembly. See “Replacing the base cover assembly” on page 71.

5. If a tool is provided with the new card to help you disconnect cables, use the tool to disconnect the cables from the old card. If no such a tool is provided, hold the cable connector with your fingers and gently disconnect each cable from the old card.

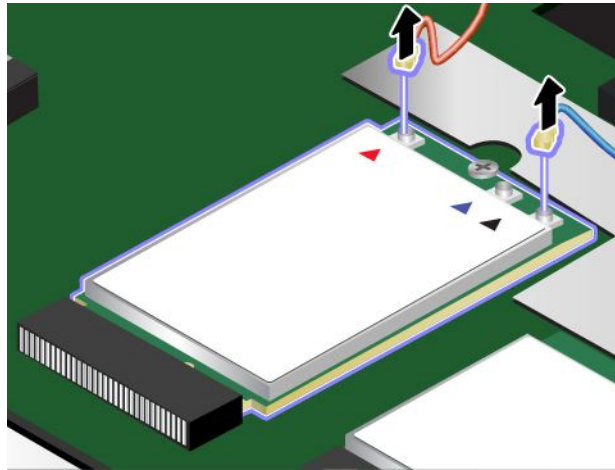

6. Remove the screw. The card is released from the secured position and pivots upward.

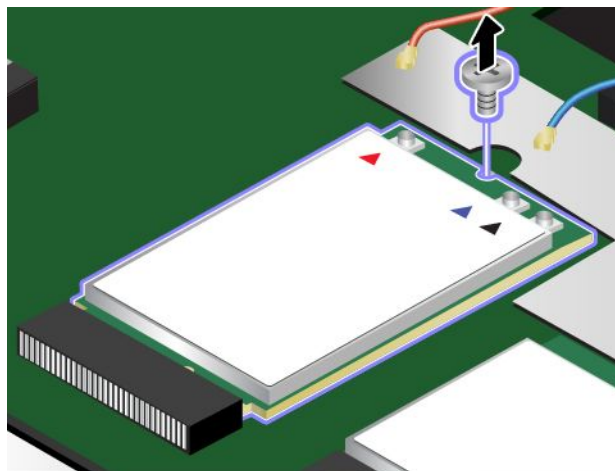

7. Carefully remove the wireless WAN card out of the slot.

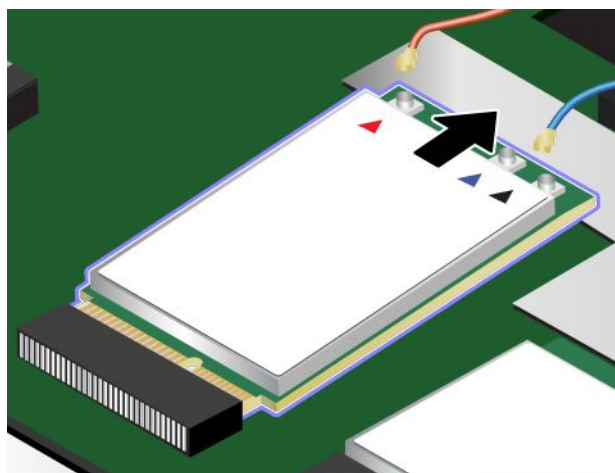

8. Align the notched edge of the new wireless WAN card with the key in the slot. Then carefully insert the card into the slot.

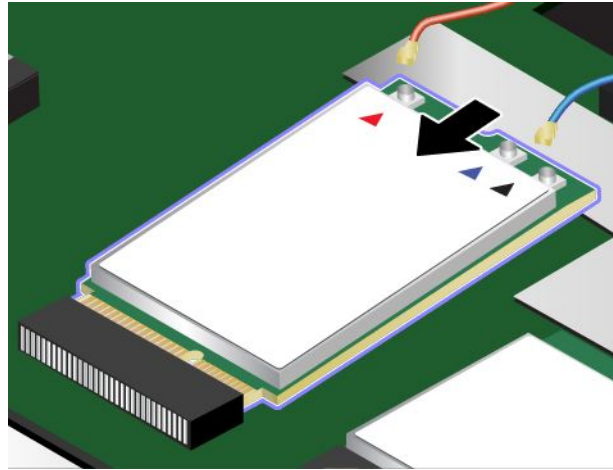

9. Pivot the new wireless WAN card downward **1** and then install the screw to secure the card in place **2**.

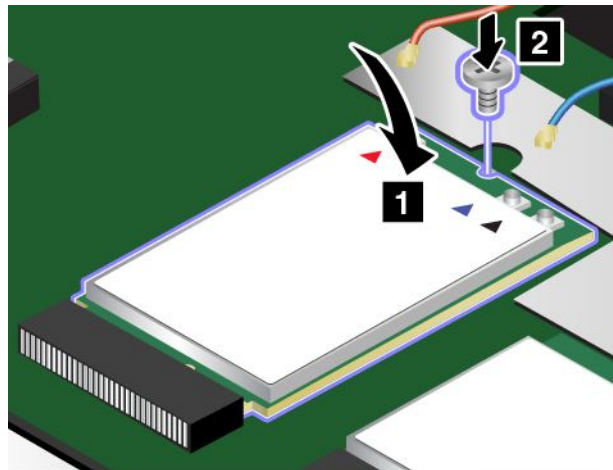

10. Connect the antenna cables to the new wireless WAN card. Ensure that you connect the red cable to the main connector on the card, and the blue cable to the auxiliary connector on the card.

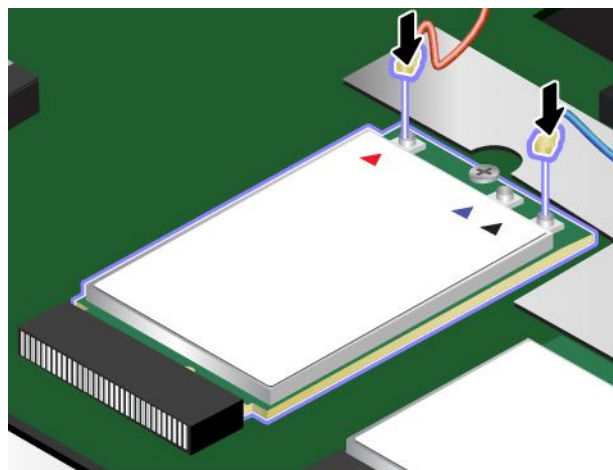

11. Reinstall the base cover assembly and the external battery pack.



12. Turn the computer over again. Connect the ac power adapter and all cables.

---

## Replacing the keyboard

Before you start, print these instructions.



**During electrical storms, do not connect the cable to or disconnect it from the telephone outlet on the wall.**



**Electric current from power, telephone, and communication cables is hazardous. To avoid shock hazard, disconnect the cables before opening the cover of this slot.**

To remove the keyboard, do the following:

1. Disable the built-in battery. See “Disabling the built-in battery” on page 67.
2. Close the computer display, and turn the computer over.
3. Remove the external battery pack. See “Replacing the external battery pack” on page 69.
4. Find the keyboard multi-tool in the shipping package of the new keyboard. The following illustration shows a keyboard multi-tool.



5. To reveal the screw heads beneath the keyboard frame, use the flat end of the multi-tool in the shipping package of the new keyboard to slide the keyboard forward by 2.5 mm (0.1 inch).

**Note:** Do not press and hold the keys while sliding the keyboard frame, otherwise the keyboard frame cannot be moved.



6. Use the cross end of the multi-tool to loosen the screws.



7. Pivot the keyboard slightly upward as shown by the arrow **1** until you can see the connectors on the bottom side of the keyboard. Then turn over the keyboard as shown by the arrow **2**.



8. Put the keyboard on the palm rest and detach the connectors. Then remove the keyboard.

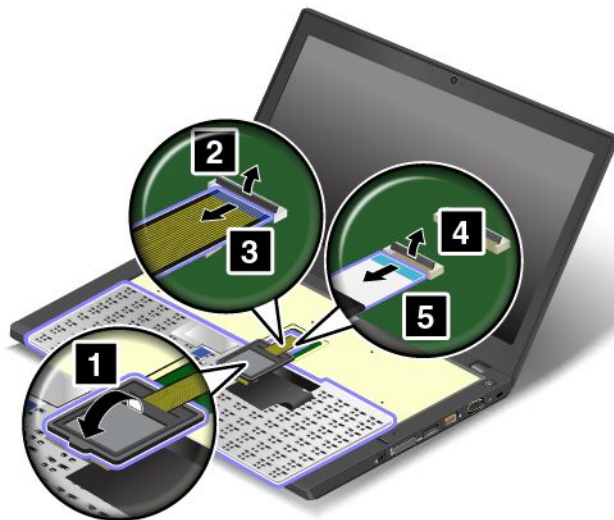

To install the new keyboard, do the following:

1. Attach the connectors, and then turn over the keyboard.

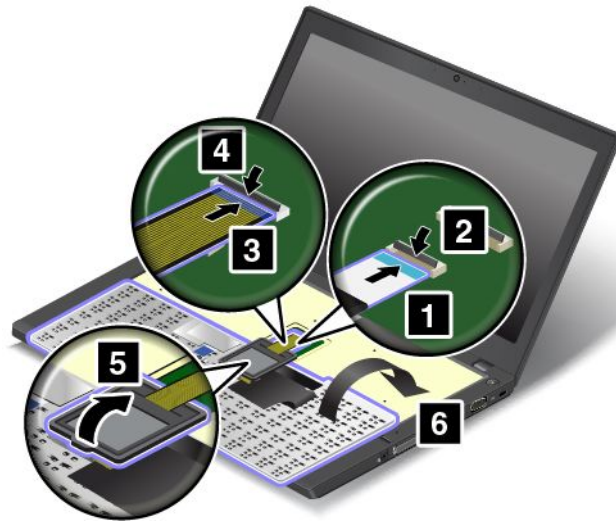

2. Insert the keyboard into the keyboard bezel as shown. Ensure that the front edge of the keyboard is under the frame of the keyboard bezel.



3. Ensure that the screw heads are exposed completely. Otherwise, reveal the screw heads by sliding the keyboard frame forward with the flat end of the keyboard multi-tool.



4. Tighten the screws with the cross end of the keyboard multi-tool to secure the keyboard in place.



5. Slide the keyboard frame backward by 2.5 mm (0.1 inch) with the flat end of the keyboard multi-tool to hide the latches of the keyboard frame under the keyboard bezel.

**Note:** Do not press and hold the keys while sliding the keyboard frame, otherwise the keyboard frame cannot be moved.



6. Insert the flat end of the keyboard multi-tool into the sides of the keyboard as shown to push the keyboard frame backward. Ensure that there is no gap between the keyboard frame and keyboard bezel.

**Note:** Do not press and hold the keys while sliding the keyboard frame, otherwise the keyboard frame cannot be moved.



7. Turn the computer over again and reinstall the external battery pack. Connect the ac power adapter and all cables.

---

## Replacing the RTC battery

Before you start, print these instructions.



**If the RTC battery is incorrectly replaced, there is danger of an explosion. The RTC battery contains a small amount of harmful substances. To avoid possible injury:**

- **Replace only with a battery of the type recommended by Lenovo.**
- **Keep the battery pack away from fire.**
- **Do not expose it to excessive heat.**
- **Do not expose it to water or rain.**
- **Do not short-circuit it.**
- **Do not drop, crush, puncture, or subject to strong forces. Battery abuse or mishandling can cause the battery to overheat, which can cause gasses or flame to “vent” from the battery pack or RTC battery.**

To replace the RTC battery, do the following:

1. Disable the built-in battery. See “Disabling the built-in battery” on page 67.
2. Close the computer display, and turn the computer over.
3. Remove the external battery pack. See “Replacing the external battery pack” on page 69.
4. Remove the base cover assembly. See “Replacing the base cover assembly” on page 71.
5. Detach the connector **1**, and then remove the RTC battery **2**.

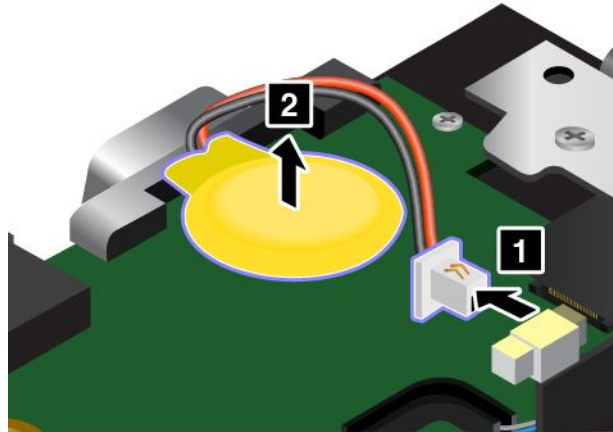

6. Install the new RTC battery **1** and attach the connector **2**.

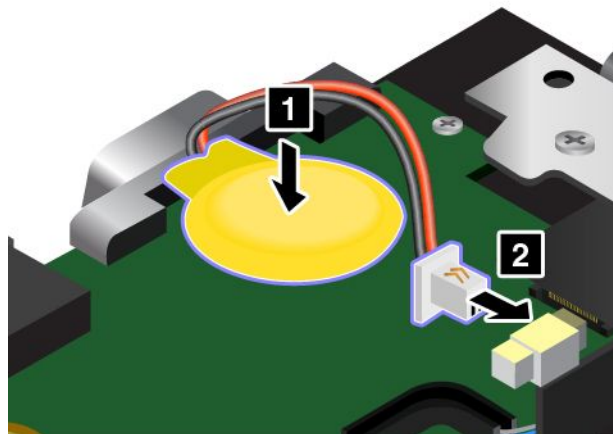

7. Reinstall the base cover assembly. See “Replacing the base cover assembly” on page 71.
8. Reinstall the external battery pack, and turn the computer over again. Connect the ac power adapter and all cables.



---

## Chapter 7. Enhancing your computer

This chapter provides instructions on how to use hardware devices to expand your computer capabilities. It includes the following topics:

- “Finding ThinkPad options” on page 89
- “ThinkPad docking stations” on page 89

---

### Finding ThinkPad options

If you want to expand the capabilities of your computer, Lenovo has a number of hardware accessories and upgrades to meet your needs. Options include memory modules, storage devices, network cards, docking stations, batteries, power adapters, printers, scanners, keyboards, mice, and more.

You can shop at Lenovo 24 hours a day, 7 days a week directly over the World Wide Web. All you need is an Internet connection and a credit card.

To shop at Lenovo, go to  
<http://www.lenovo.com/accessories/services/index.html>

---

### ThinkPad docking stations

If there is a docking station connector on the bottom of your computer, you can attach your computer to a supported docking station to expand working capability. Depending on the model, your computer might support the following docking stations:

- ThinkPad Basic Dock
- ThinkPad Pro Dock
- ThinkPad Ultra Dock

#### **CAUTION:**

**When the computer is attached to a docking station, never pick up the assembly by taking hold of the computer alone. Always hold the whole assembly.**

### Locating controls and connectors on the ThinkPad docking stations

This section introduces the locations of controls and connectors on the ThinkPad docking stations.

## ThinkPad Basic Dock

### Front view

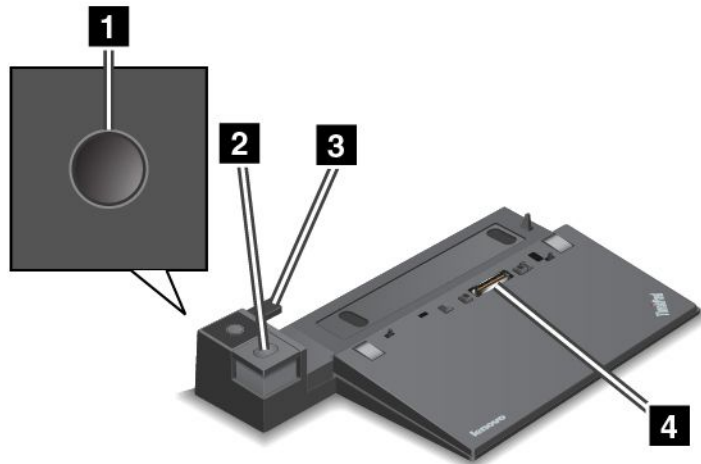

**1 Power button:** Press the power button to turn on or turn off the computer .

**2 Eject button:** Press the eject button to release the computer from the docking station.

**3 Sliding adjuster:** Use the sliding adjuster as a guide to align the docking station connector on your computer when you attach the docking station.

**4 Docking station connector:** Used to attach your computer.

### Rear view

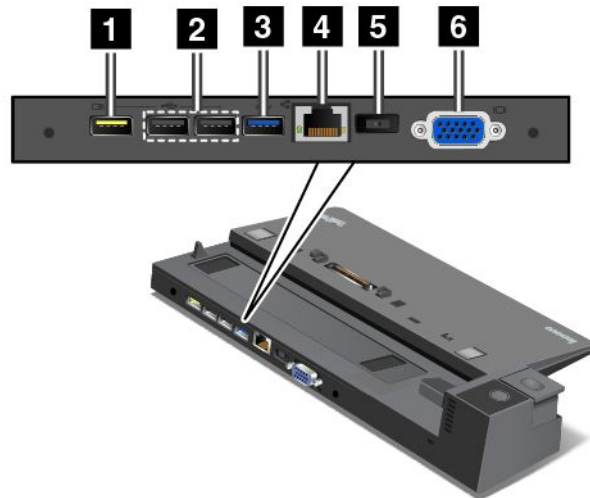

**1 Always On USB connector:** Used to connect devices that are compatible with USB 2.0 or charge some mobile digital devices and smartphones when your computer is in sleep or hibernation mode.

**2 USB 2.0 connectors:** Used to connect devices that are compatible with USB 2.0.

**3 USB 3.0 connector:** Used to connect devices that are compatible with USB 3.0.

**4 Ethernet connector:** Used to connect the docking station to an Ethernet LAN.

**Note:** If you need to use an Ethernet connector or an external monitor connector when your computer is attached to a docking station, use the Ethernet connector or the external monitor connector on the docking station, instead of the one on the computer.

**5 ac power connector:** Used to connect the ac power adapter.

**6 VGA connector:** Used to connect the computer to a VGA-compatible video device, such as a VGA monitor.

## ThinkPad Pro Dock

### Front view

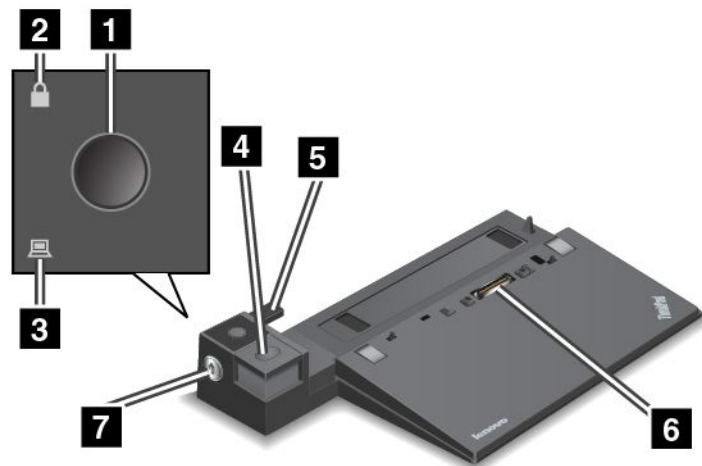

**1 Power button:** Press the power button to turn on or turn off the computer.

**2 Key lock indicator:** This indicator turns on when the system lock key is in the locked position.

**3 Docking status indicator:** This indicator turns on when your computer is docked.

**4 Eject button:** Press the eject button to release the computer from the docking station.

**5 Sliding adjuster:** Use the sliding adjuster as a guide to align the docking station connector on your computer when you attach the docking station.

**6 Docking station connector:** Used to attach your computer.

**7 System lock:** Use the system lock key to lock the eject button. When the system lock key is in the locked position, the eject button of the docking station is locked; you cannot attach or remove your computer.

## Rear view

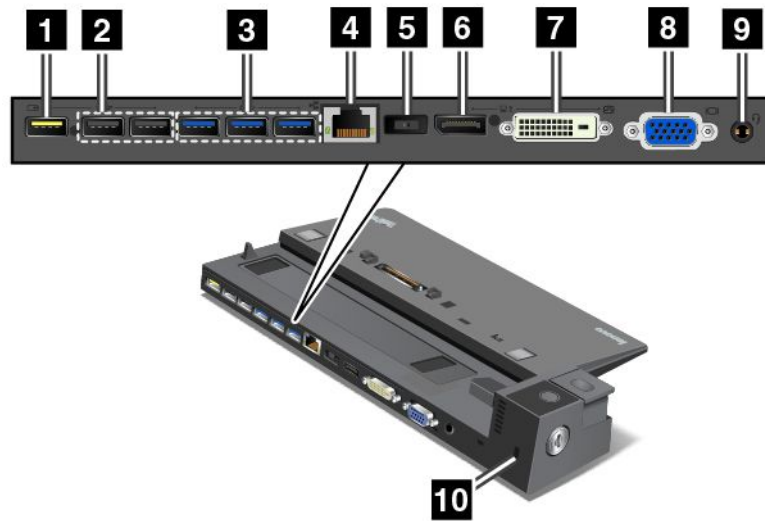

**1 Always On USB connector:** Used to connect devices that are compatible with USB 2.0 or charge some mobile digital devices and smartphones when your computer is in sleep or hibernation mode.

**2 USB 2.0 connectors:** Used to connect devices that are compatible with USB 2.0.

**3 USB 3.0 connectors:** Used to connect devices that are compatible with USB 3.0.

**4 Ethernet connector:** Used to connect the docking station to an Ethernet LAN.

**Note:** If you need to use an Ethernet connector or an external monitor connector when your computer is attached to a docking station, use the Ethernet connector or the external monitor connector on the docking station, instead of the one on the computer.

**5 ac power connector:** Used to connect the ac power adapter.

**6 DisplayPort connector:** Used to attach a high-performance monitor, a direct-drive monitor, or other devices that use a DisplayPort connector.

**7 DVI connector:** Used to connect a monitor that supports Digital Visual Interface (DVI) connection.

**Note:** The DVI connector provides a digital interface only. This connector can only be used with a computer that supports DVI connection.

**8 VGA connector:** Used to connect the computer to a VGA-compatible video device, such as a VGA monitor.

**9 Audio connector:** Used to connect headphones or a headset that has a 3.5-mm (0.14-inch) 4-pole plug to the audio connector to listen to the sound from the computer.

**10 Security-lock slot:** To protect your docking station from theft, you can use a security cable lock, such as a Kensington-style cable lock, that fits this security-lock slot to lock your docking station to a desk, table, or other non-permanent fixture.

## ThinkPad Ultra Dock

### Front view

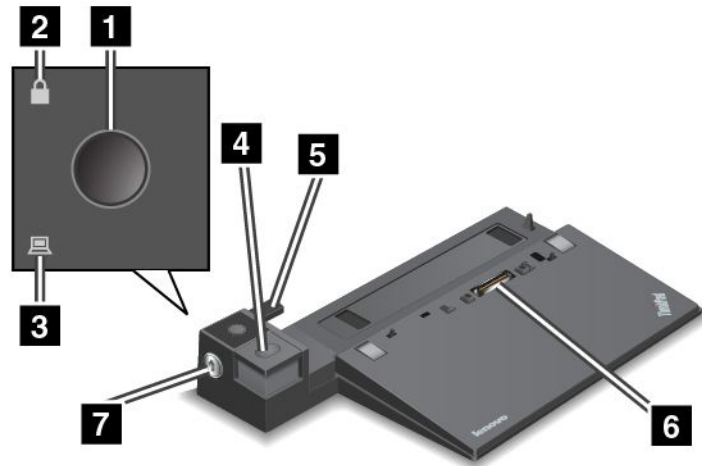

**1 Power button:** Press the power button to turn on or turn off the computer.

**2 Key lock indicator:** This indicator turns on when the system lock key is in the locked position.

**3 Docking status indicator:** This indicator turns on when your computer is docked.

**4 Eject button:** Press the eject button to release the computer from the docking station.

**5 Sliding adjuster:** Use the sliding adjuster as a guide to align the docking station connector on your computer when you attach the docking station.

**6 Docking station connector:** Used to attach your computer.

**7 System lock:** Use the system lock key to lock the eject button. When the system lock key is in the locked position, the eject button of the docking station is locked; you cannot attach or remove your computer.

### Rear view

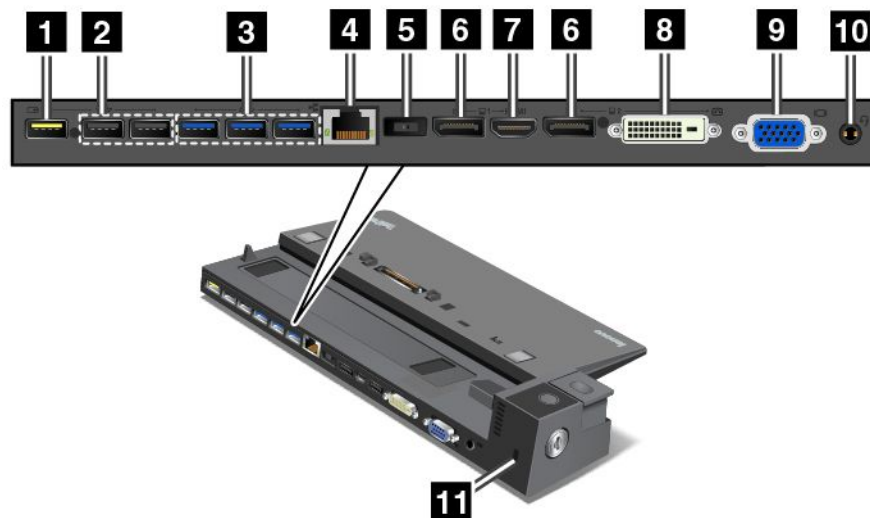

**1 Always On USB connector:** Used to connect devices that are compatible with USB 2.0 or charge some mobile digital devices and smartphones when your computer is in sleep or hibernation mode.

**2 USB 2.0 connectors:** Used to connect devices that are compatible with USB 2.0.

**3 USB 3.0 connectors:** Used to connect devices that are compatible with USB 3.0.

**4 Ethernet connector:** Used to connect the docking station to an Ethernet LAN.

**Note:** If you need to use an Ethernet connector or an external monitor connector when your computer is attached to a docking station, use the Ethernet connector or the external monitor connector on the docking station, instead of the one on the computer.

**5 ac power connector:** Used to connect the ac power adapter.

**6 DisplayPort connectors:** Used to attach a high-performance monitor, a direct-drive monitor, or other devices that use a DisplayPort connector.

**7 HDMI connector:** Used to connect a high-definition television.

**8 DVI connector:** Used to connect a monitor that supports Digital Visual Interface (DVI) connection.

**Note:** The DVI connector provides a digital interface only. This connector can only be used with a computer that supports DVI connection.

**9 VGA connector:** Used to connect the computer to a VGA-compatible video device, such as a VGA monitor.

**10 Audio connector:** Used to connect headphones or a headset that has a 3.5-mm (0.14-inch) 4-pole plug to the audio connector to listen to the sound from the computer.

**11 Security-lock slot:** To protect your docking station from theft, you can use a security cable lock, such as a Kensington-style cable lock, that fits this security-lock slot to lock your docking station to a desk, table, or other non-permanent fixture.

## Attaching a ThinkPad docking station

To attach your computer to a supported ThinkPad docking station, do the following:

**Note:** The ThinkPad Basic Dock does not have the system lock.

1. Disconnect all cables and devices from the computer.
2. Ensure that the system lock key is turned to the unlocked position (horizontal).

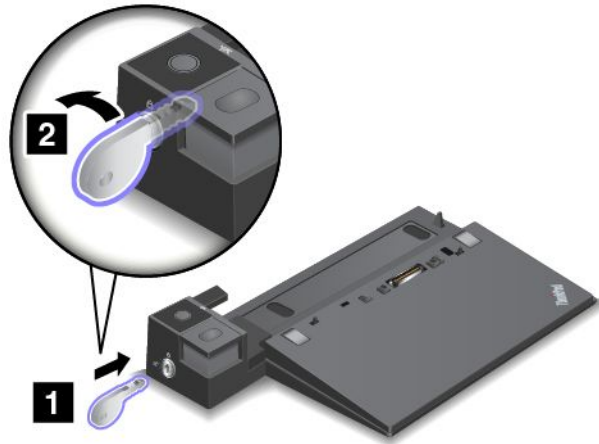

3. Align the top-left corner of the computer with the position mark of the docking station. Attach your computer to the docking station vertically until you hear a click **1**. Then turn the system lock key to the locked position **2**.

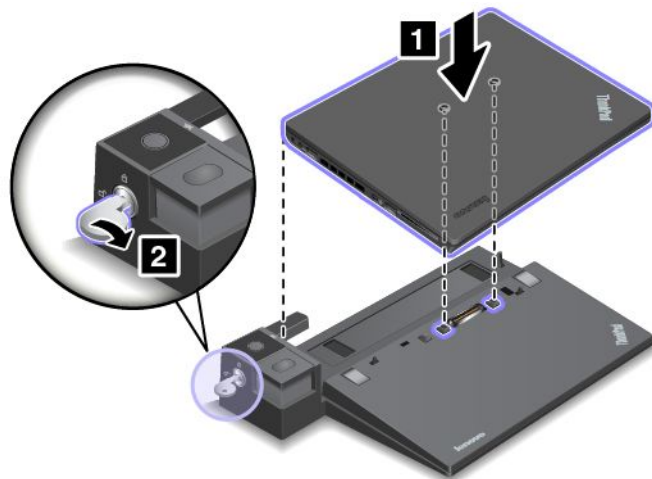

4. Check the docking status indicator. If the docking status indicator is not turned on, it indicates that your computer is not correctly attached to the docking station. Check the ac power adapter of the docking station, or disconnect and reattach the ac power adapter.

**Note:** The computer will be in battery mode if you attach it to a docking station that is not connected to ac power.

## Detaching a ThinkPad docking station

To detach your computer from a ThinkPad docking station, do the following:

**Note:** The ThinkPad Basic Dock does not have the system lock.

1. Disconnect all cables and devices from the computer.
2. Ensure that the system lock key is turned to the unlocked position (horizontal).

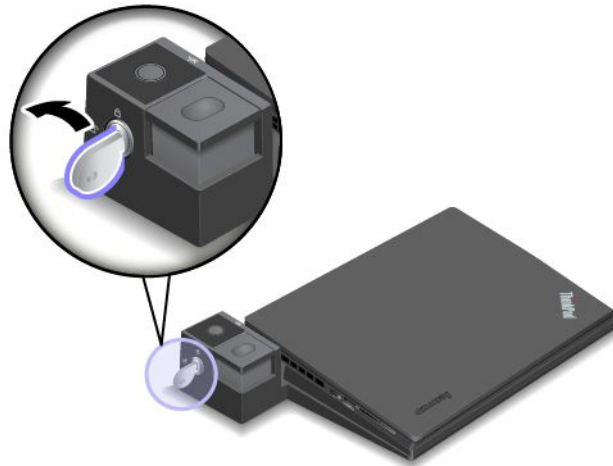

3. Press the eject button until the computer moves up. Then, grasp both sides of the computer to remove it.

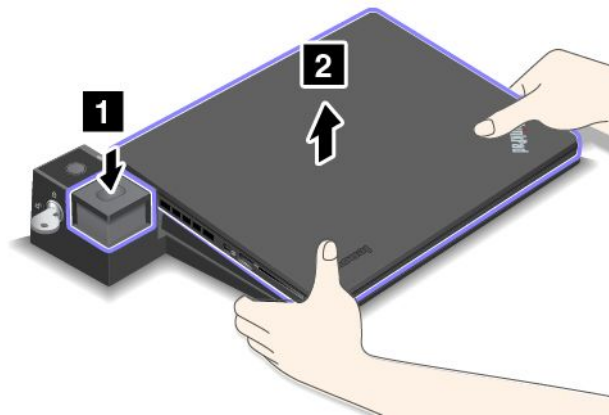

## Connecting external displays to a docking station

For the ThinkPad Pro Dock, if you connect two external displays to the DisplayPort connector and the DVI connector, the DVI connector is inactive.



For the ThinkPad Ultra Dock, if you connect two external displays to the DisplayPort connector and the DVI connector, the DVI connector is inactive.





For the ThinkPad Ultra Dock, if you connect two external displays to the DisplayPort connector and the HDMI connector, the HDMI connector is inactive.

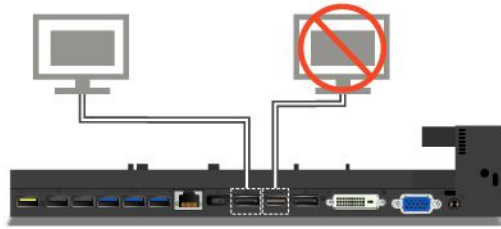

## Security features

The system lock key has two positions as shown in the drawing.

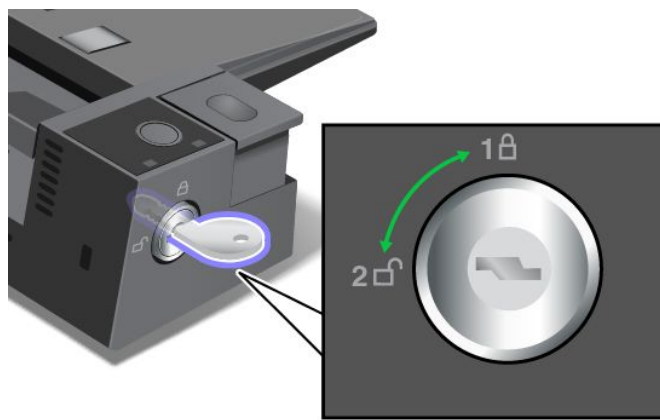

The security feature is different when the key is in different positions:

- When the key is in position 1, the eject button of the docking station is locked, and you cannot remove your computer. The key lock indicator is on when the eject button is locked. The security cable is locked.
- When the key is in position 2, the eject button of the docking station is unlocked, and you can remove your computer. The key lock indicator is off when the eject button is unlocked. The security cable is locked.



---

## Chapter 8. Advanced configuration

This chapter provides the following information to help you configure the computer:

- “Installing a new operating system” on page 99
- “Installing device drivers” on page 101
- “Using the ThinkPad Setup program” on page 101
- “Using system management” on page 113

---

### Installing a new operating system

In some situations, you might need to install a new operating system. This topic provides instructions on how to install a new operating system.

### Installing the Windows 7 operating system

Before you start, print these instructions.

#### Attention:

- The process of installing a new operating system deletes all the data on your hard disk drive or solid-state drive, including the data that were stored in a hidden folder.
- If your computer is equipped with both a hard disk drive and an M.2 solid-state drive, do not use the M.2 solid-state drive as a bootable device. The M.2 solid-state drive is used for “cache” function and to support the Intel Rapid Start Technology.

To install the Windows 7 operating system, do the following:

1. Copy all the subdirectories and files in the C:\SWT00LS directory to a removable storage device.
  - The supplement files for the Windows 7 operating system are in the C:\SWT00LS\OSFIXES directory.
  - The device drivers are in the C:\SWT00LS\DRIVERS directory.
  - The preinstalled programs are in the C:\SWT00LS\APPS directory.
2. Start the ThinkPad Setup program. See “Using the ThinkPad Setup program” on page 101.
3. Select **Startup → UEFI/Legacy Boot**. Then do one of the following:
  - To install the Windows 7 (32-bit) operating system, select **Legacy Only** or **Both**.
  - To install the Windows 7 (64-bit) operating system in Legacy mode, select **Legacy Only**.
  - To install the Windows 7 (64-bit) operating system in UEFI mode, select **UEFI Only**.
4. Press F10. A Setup Confirmation window is displayed. Click **Yes** to save the configuration and exit the ThinkPad Setup program.
5. Insert the Windows 7 operating system installation DVD into the optical drive, and restart the computer.
6. Restore the C:\SWT00LS directory that you backed up before installing the Windows 7 operating system.
7. Install the device drivers. See “Installing device drivers” on page 101.
8. Install the Windows 7 fix modules. You can find the Windows 7 fix modules in the C:\SWT00LS\OSFIXES\ directory. For more information, go to the Microsoft Knowledge Base home page at: <http://support.microsoft.com/>
9. Install the registry patches, for example the Enabling Wake on LAN from Standby for ENERGY STAR patch. To download and install the registry patches, go to the Lenovo Support Web site at: <http://www.lenovo.com/support>

**Note:** After installing the operating system, do not change the initial **UEFI/Legacy Boot** setting in the ThinkPad Setup program. Otherwise the operating system will not start correctly.

When you install the Windows 7 operating system, you might need one of the following country or region codes:

Country or region	Code	Country or region	Code
China	SC	Netherlands	NL
Denmark	DK	Norway	NO
Finland	FI	Spain	SP
France	FR	Sweden	SV
Germany	GR	Taiwan and Hong Kong	TC
Italy	IT	United States	US
Japan	JP		

## Installing the Windows 8 operating system

Before you start, print these instructions.

### Attention:

- The process of installing a new operating system deletes all the data on your hard disk drive or solid-state drive, including the data that were stored in a hidden folder.
- If your computer is equipped with both a hard disk drive and an M.2 solid-state drive, do not use the M.2 solid-state drive as a bootable device. The M.2 solid-state drive is used for “cache” function and to support the Intel Rapid Start Technology.

To install the Windows 8 operating system, do the following:

1. Start the ThinkPad Setup program. See “Using the ThinkPad Setup program” on page 101.
2. Select **Startup → Boot** to display the **Boot Priority Order** submenu.
3. Select the drive that contains the Windows 8 operating system installation program, for example **USB HDD**.
4. Press F10. A Setup Confirmation window is displayed. Click **Yes** to save the configuration and exit the ThinkPad Setup program.
5. Connect the drive that contains the Windows 8 operating system installation program to the computer, and restart the computer.
6. Install the Windows 8 fix modules. Go to the Microsoft Knowledge Base home page at <http://support.microsoft.com/>. Type the number of the fix module in the search field, then click **Search**.
7. Install the registry patches, for example the Enabling Wake on LAN from Standby for ENERGY STAR patch. To download and install the registry patches, go to the Lenovo Support Web site at: <http://www.lenovo.com/support>
8. Install the device drivers. See “Installing device drivers” on page 101.

**Note:** After installing the operating system, do not change the initial **UEFI/Legacy Boot** setting in the ThinkPad Setup program. Otherwise, the operating system will not start correctly.

When you install the Windows 8 operating system, you might need one of the following country or region codes:

Country or region	Code	Country or region	Code
China	SC	Netherlands	NL
Denmark	DK	Norway	NO
Finland	FI	Spain	SP
France	FR	Sweden	SV
Germany	GR	Taiwan and Hong Kong	TC
Italy	IT	United States	US
Japan	JP		

---

## Installing device drivers

Device driver is the program that operates a particular hardware device of the computer. If a device does not perform well or you install a new device, you need to install or update the corresponding device driver. For example, if you use the Windows 7 operating system, to use the USB 3.0 connector, you need to download and install the USB 3.0 driver.

To download the latest device drivers, do the following:

1. Go to <http://www.lenovo.com/ThinkPadDrivers>.
2. Select your product name to view all the device drivers for your computer.
3. Select the device drivers you that you need, and follow the instructions on the screen.

**Attention:** Do not download the device drivers from the Windows Update Web. Always download the device drivers from:

<http://www.lenovo.com/ThinkPadDrivers>

If you use the Windows 7 operating system, you also can find the device drivers in the C:\SWTOOLS\DRIVERS directory on your hard disk drive or solid-state drive. For more information, see “Reinstalling preinstalled programs and device drivers” on page 63.

---

## Using the ThinkPad Setup program

The ThinkPad Setup program enables you to select various setup configurations for your computer through configuring the BIOS.

To configure the BIOS of your computer, do the following:

1. Restart the computer. When the ThinkPad logo is displayed, press F1 to start the ThinkPad Setup program.

**Note:** If you are required to enter the supervisor password, enter the correct password. You also can press Enter to skip the password prompt and start the ThinkPad Setup program. If you do not enter the password, you cannot change the configurations that are protected by the supervisor password. For more information, refer to “Using passwords” on page 47.

2. Use the cursor keys to select a tab; or use the cursor keys to locate an item and press Enter to select it. Then a submenu is displayed.

**Note:** Some menu items are displayed only if the computer supports the corresponding features.

3. Set the value of an item by doing one of the following:

- Press F6 to change to a higher value.
- Press F5 to change to a lower value.

**Note:** Default values are in **boldface**.

4. To change other configurations, press the Esc key to exit the submenu and return to the parent menu.
5. When you complete the configuration, press F10. A Setup Confirmation window is displayed. Click **Yes** to save the configuration and exit the ThinkPad Setup program. You also can select the **Restart** tab in the ThinkPad Setup menu, and restart your computer with one of the provided options.

**Note:** You can press F9 to restore to the default settings.

## Main menu

When you enter the ThinkPad Setup program, you will first see the **Main** menu as follows:

- UEFI BIOS Version
- UEFI BIOS Date
- Embedded Controller Version
- ME Firmware Version
- Machine Type Model
- System-unit serial number
- System board serial number
- Asset Tag
- CPU Type
- CPU Speed
- Installed memory
- UUID
- MAC Address (Internal LAN)
- Preinstalled operating system license
- UEFI Secure Boot

## Config menu

To change the configuration of your computer, select the **Config** tab from the ThinkPad Setup menu.

The following table lists the **Config** menu items. Default values are in **boldface**.

**Attention:** The default configurations are already optimized for you. Improper change of the configurations might cause unexpected results.

Table 4. Config menu items

Menu item	Submenu item	Value	Comments
<b>Network</b>	Wake On LAN	<ul style="list-style-type: none"><li>• Disabled</li><li>• <b>AC only</b></li><li>• AC and Battery</li></ul>	<p>Enable the computer to power on when the Ethernet controller receives a magic packet (a special network message).</p> <p>If you select <b>AC Only</b>, Wake on LAN function is enabled only when the ac power adapter is attached.</p>

Table 4. Config menu items (continued)

Menu item	Submenu item	Value	Comments
			<p>If you select <b>AC and Battery</b>, Wake on LAN function is enabled with any power sources.</p> <p><b>Notes:</b></p> <ul style="list-style-type: none"> <li>• The magic packet type Wake on LAN requires ac power.</li> <li>• The Wake on LAN function does not work when a hard disk password is set.</li> </ul>
	Ethernet LAN Option ROM (for <b>Legacy Only</b> boot mode or <b>Both</b> with <b>Legacy first</b> )	<ul style="list-style-type: none"> <li>• Disabled</li> <li>• <b>Enabled</b></li> </ul>	Load the Ethernet LAN Option ROM to enable startup from an integrated network device.
	UEFI IPv4 Network Stack (for <b>UEFI Only</b> boot mode or <b>Both</b> with <b>UEFI first</b> )	<ul style="list-style-type: none"> <li>• Disabled</li> <li>• <b>Enabled</b></li> </ul>	Enable or disable Internet Protocol Version 4 (IPv4) network stack for UEFI environment.
	UEFI IPv6 Network Stack (for <b>UEFI Only</b> boot mode or <b>Both</b> with <b>UEFI first</b> )	<ul style="list-style-type: none"> <li>• Disabled</li> <li>• <b>Enabled</b></li> </ul>	Enable or disable Internet Protocol Version 6 (IPv6) network stack for UEFI environment.
	UEFI PXE Boot Priority (for <b>Both</b> with <b>UEFI first</b> boot mode, and IPv6 and IPv4 stacks are both enabled.)	<ul style="list-style-type: none"> <li>• IPv6 First</li> <li>• <b>IPv4 First</b></li> </ul>	Select network stack priority for UEFI PXE boot.
<b>USB</b>	USB UEFI BIOS Support	<ul style="list-style-type: none"> <li>• Disabled</li> <li>• <b>Enabled</b></li> </ul>	Enable or disable boot support for USB storage devices.
	Always On USB	<ul style="list-style-type: none"> <li>• Disabled</li> <li>• <b>Enabled</b></li> </ul>	If you select <b>Enabled</b> , the external USB devices can be charged through USB connectors even when the computer is in low-power mode (sleep, hibernate, or power-off).
	- Charge in Battery Mode	<ul style="list-style-type: none"> <li>• <b>Disabled</b></li> <li>• Enabled</li> </ul>	If you select <b>Enabled</b> , external USB devices can be charged through USB connectors even when the system is in hibernation mode, or is power-off and in battery operation.
	USB 3.0 Mode	<ul style="list-style-type: none"> <li>• Disabled</li> <li>• <b>Enabled</b></li> </ul>	Set the USB 3.0 controller mode for the ports shared between USB 2.0 and USB 3.0 controllers.

Table 4. Config menu items (continued)

Menu item	Submenu item	Value	Comments
		<ul style="list-style-type: none"> <li>• <b>Auto</b></li> </ul>	<p>If you select <b>Auto</b>, it enables you to connect and route appropriate USB 3.0 or USB 2.0 connectors.</p> <p>If you select <b>Enabled</b>, it enables USB 3.0 mode and allows USB 3.0 to be supported in the operating system.</p> <p>If you select <b>Disabled</b>, it disables and hides the USB 3.0 controller, and USB 3.0 connectors will work as USB 2.0 connectors.</p>
<b>Keyboard/Mouse</b>	TrackPoint	<ul style="list-style-type: none"> <li>• Disabled</li> <li>• <b>Enabled</b></li> </ul>	<p>Enable or disable the built-in TrackPoint pointing device.</p> <p><b>Note:</b> If you want to use an external mouse, select <b>Disabled</b>.</p>
	Trackpad	<ul style="list-style-type: none"> <li>• Disabled</li> <li>• <b>Enabled</b></li> </ul>	<p>Enable or disable the built-in trackpad.</p> <p><b>Note:</b> If you want to use an external mouse, select <b>Disabled</b>.</p>
	Fn and Ctrl Key swap	<ul style="list-style-type: none"> <li>• <b>Disabled</b></li> <li>• Enabled</li> </ul>	<p>If you select <b>Enabled</b>, the Fn key works as the Ctrl key, and the Ctrl key works as the Fn key.</p> <p><b>Note:</b> Even when <b>Enabled</b> is selected, you need to press Fn to resume the computer from sleep mode to normal operation.</p>
<b>Display</b>	Boot Display Device	<ul style="list-style-type: none"> <li>• <b>ThinkPad LCD</b></li> <li>• Analog (VGA)</li> <li>• Digital on ThinkPad</li> <li>• Display on dock</li> </ul>	<p>Select the display device that is to be activated at boot time. This selection is effective for boot time, password prompt, and ThinkPad Setup.</p> <p><b>Digital on ThinkPad</b> is the Mini DisplayPort connector on your computer.</p> <p><b>Display on dock</b> is DisplayPort, DVI or VGA</p>



Table 4. Config menu items (continued)

Menu item	Submenu item	Value	Comments
			connectors on a docking station.
<b>Power</b>	Intel SpeedStep® technology	<ul style="list-style-type: none"> <li>• Disabled</li> <li>• <b>Enabled</b></li> </ul> <p>Mode for AC</p> <ul style="list-style-type: none"> <li>• <b>Maximum Performance</b></li> <li>• Battery Optimized</li> </ul> <p>Mode for Battery</p> <ul style="list-style-type: none"> <li>• Maximum Performance</li> <li>• <b>Battery Optimized</b></li> </ul>	<p>Select the mode of Intel SpeedStep technology at runtime.</p> <p><b>Maximum Performance:</b> Always the highest speed.</p> <p><b>Battery Optimized:</b> Always the lowest speed.</p> <p><b>Disabled:</b> The highest speed, and runtime is not supported.</p>
	Adaptive Thermal Management	<p>Scheme for AC</p> <ul style="list-style-type: none"> <li>• <b>Maximize Performance</b></li> <li>• Balanced</li> </ul> <p>Scheme for Battery</p> <ul style="list-style-type: none"> <li>• Maximize Performance</li> <li>• <b>Balanced</b></li> </ul>	<p>Select a thermal management scheme to use.</p> <p><b>Maximize Performance:</b> Reduce microprocessor throttling.</p> <p><b>Balanced:</b> Balance sound, temperature, and performance.</p> <p><b>Note:</b> Each scheme affects fan sound, temperature, and performance.</p>
	CPU Power Management	<ul style="list-style-type: none"> <li>• Disabled</li> <li>• <b>Enabled</b></li> </ul>	<p>Enable or disable the power-saving feature that stops the microprocessor clock automatically when there are no system activities. Normally, it is not necessary to change the setting.</p>
	Power On with AC Attach	<ul style="list-style-type: none"> <li>• <b>Disabled</b></li> <li>• Enabled</li> </ul>	<p>Enable or disable the feature that powers on the system when the ac power adapter is attached.</p> <p>If you select <b>Enabled</b>, the system is powered on when the ac power adapter is attached. If the system is in hibernate state, the system resumes normal operation.</p> <p>If you select <b>Disabled</b>, the system is not powered on nor resumed when the ac power adapter is attached.</p>

Table 4. Config menu items (continued)

Menu item	Submenu item	Value	Comments
	Intel Rapid Start Technology	<ul style="list-style-type: none"> <li>• Disabled</li> <li>• <b>Enabled</b></li> </ul> Enter after: <ul style="list-style-type: none"> <li>• Immediately</li> <li>• 1 minute</li> <li>• 2 minutes</li> <li>• 5 minutes</li> <li>• 10 minutes</li> <li>• 15 minutes</li> <li>• 30 minutes</li> <li>• 1 hour</li> <li>• 2 hours</li> <li>• <b>3 hours</b></li> </ul>	To use this feature, a special partition on the solid-state drive is required.  When enabled, the computer enters a lower power state after the specified time in sleep state. And it takes only seconds to resume normal operation.
	Disable Built-in Battery	<ul style="list-style-type: none"> <li>• Yes</li> <li>• <b>No</b></li> </ul>	Temporarily disable the built-in battery for servicing the computer. After selecting this item, the computer will be automatically powered off.  <b>Note:</b> The battery will be automatically re-enabled when the ac power adapter is reconnected to the computer.
<b>Beep and Alarm</b>	Password Beep	<ul style="list-style-type: none"> <li>• <b>Disabled</b></li> <li>• Enabled</li> </ul>	Enable this option to have a beep sound when the system is waiting for a power-on, hard disk, or supervisor password. Different beeps will sound when the entered password matches or does not match the configured password.
	Keyboard Beep	<ul style="list-style-type: none"> <li>• <b>Enabled</b></li> <li>• Disabled</li> </ul>	Enable or disable keyboard beep when unmanageable key combinations are pressed.
<b>Intel AMT</b>	Intel AMT Control	<ul style="list-style-type: none"> <li>• Disabled</li> <li>• <b>Enabled</b></li> <li>• Permanently Disabled</li> </ul>	If you select <b>Enabled</b> , Intel Active Management Technology (AMT) is configured and additional setup items are provided in Management Engine BIOS Extension (MEBx) Setup.  If you select <b>Permanently Disabled</b> , you will never be able to enable it again. Be cautious when you want to use this option.  <b>Note:</b> You can enter the MEBx Setup menu by pressing the Ctrl+P key

Table 4. Config menu items (continued)

Menu item	Submenu item	Value	Comments
			combination in the Startup Interrupt Menu window. To display the Startup Interrupt Menu window, press the black button or Enter key during the power-on self-test (POST).
	CIRA Timeout	0-255 <b>Note:</b> The default value is 60 seconds.	Set the timeout option for CIRA connection to be established. Selectable second values are from 1 to 254.  If you select <b>0</b> , use 60 seconds as the default timeout value.  If you select <b>255</b> , the waiting time for establishing a connection is unlimited.
	Console Type	<ul style="list-style-type: none"> <li>• PC ANSI</li> <li>• <b>VT100+</b></li> <li>• PC-ANSI</li> <li>• VT-UTF8</li> </ul>	Select the console type for AMT.  <b>Note:</b> This console type should match the Intel AMT remote console.

## Date and Time menu

To change the date or time of your computer, select the **Date/Time** tab from the ThinkPad Setup menu. Then do the following:

1. Use the cursor keys to select **System Dtae** or **System Time**.
2. Type a date or time.

## Security menu

To change the security settings of your computer, select the **Security** tab from the ThinkPad Setup menu.

The following table lists the **Security** menu items. Default values are in **boldface**.

**Attention:** The default configurations are already optimized for you. Improper change of the configurations might cause unexpected results.

Table 5. Security menu items

Menu item	Submenu item	Value	Comments
<b>Password</b>	Hardware Password Manager	<ul style="list-style-type: none"> <li>• Disabled</li> <li>• <b>Enabled</b></li> </ul>	Manage your power-on password, supervisor password, and your hard disk passwords.
	Supervisor Password	<ul style="list-style-type: none"> <li>• <b>Disabled</b></li> <li>• Enabled</li> </ul>	For more information, see “Supervisor password” on page 48.
	Lock UEFI BIOS Settings	<ul style="list-style-type: none"> <li>• <b>Disabled</b></li> <li>• Enabled</li> </ul>	Enable or disable the function that protects items in ThinkPad Setup from being changed by a user who does not have the supervisor

Table 5. Security menu items (continued)

Menu item	Submenu item	Value	Comments
			password. By default, this is set to <b>Disabled</b> . If you set the supervisor password and enable this function, no one but you can change the items in ThinkPad Setup.
	Password at unattended boot	<ul style="list-style-type: none"> <li>• Disabled</li> <li>• <b>Enabled</b></li> </ul>	If you select and enable <b>Password at unattended boot</b> , a password prompt is displayed when the computer is turned on, from either a power-off state or hibernation state, by an unattended event such as a Wake on LAN attempt. If you select <b>Disabled</b> , no password prompt is displayed; the computer goes ahead and loads the operating system. To prevent unauthorized access, set the user authentication on the operating system.
	Password at restart	<ul style="list-style-type: none"> <li>• <b>Disabled</b></li> <li>• Enabled</li> </ul>	If you select and enable <b>Password at restart</b> , a password prompt is displayed when you restart the computer. If you select <b>Disabled</b> , no password prompt is displayed; the computer goes ahead and loads the operating system. To prevent unauthorized access, set the user authentication on the operating system.
	Set Minimum Length	<ul style="list-style-type: none"> <li>• <b>Disabled</b></li> <li>• x characters (4≤x≤12)</li> </ul>	Specify a minimum length for power-on passwords and hard disk passwords. If you set the supervisor password and specify a minimum length for passwords, no one but you can change the length.
	Power-On Password	<ul style="list-style-type: none"> <li>• <b>Disabled</b></li> <li>• Enabled</li> </ul>	For more information, see “Power-on password” on page 47.
	Hard Disk x Password	<ul style="list-style-type: none"> <li>• <b>Disabled</b></li> <li>• Enabled</li> </ul>	For more information, see “Hard disk passwords” on page 49.  <b>Note: Hard Disk 1</b> means the hard disk drive is built into your computer.
<b>Fingerprint</b>	Predesktop Authentication	<ul style="list-style-type: none"> <li>• Disabled</li> <li>• <b>Enabled</b></li> </ul>	Enable or disable fingerprint authentication before the operating system is loaded.
	Reader Priority	<ul style="list-style-type: none"> <li>• <b>External → Internal</b></li> <li>• Internal Only</li> </ul>	If <b>External → Internal</b> is selected, an external fingerprint reader is used if attached. Otherwise, an internal fingerprint reader is used. If <b>Internal Only</b> is selected, an internal fingerprint reader is used.
	Security Mode	<ul style="list-style-type: none"> <li>• <b>Normal</b></li> <li>• High</li> </ul>	If fingerprint authentication fails, you still can start the computer by entering a password. If you have selected <b>Normal</b> , enter a power-on password or a supervisor password; if you have selected <b>High</b> , enter a supervisor password.
	Password Authentication	<ul style="list-style-type: none"> <li>• Disabled</li> <li>• <b>Enabled</b></li> </ul>	Enable or disable password authentication. This item is available when high security mode is selected.
	Reset Fingerprint Data	<ul style="list-style-type: none"> <li>• <b>Enter</b></li> </ul>	This option is used to erase all fingerprint data stored in the fingerprint reader and reset settings to the factory state. As a result, any power-on security features previously enabled will not be

Table 5. Security menu items (continued)

Menu item	Submenu item	Value	Comments
			able to work until they are re-enabled in the fingerprint software.
<b>Security Chip</b>	Security Chip Selection	<ul style="list-style-type: none"> <li>• <b>Discrete TPM</b></li> <li>• Intel PPT</li> </ul>	<p>If you select <b>Discrete TPM</b>, you can use a discrete TPM chip with TPM 1.2 mode. If you select <b>Intel PTT</b>, you can use Intel Platform Trusted technology (PTT) with TPM 2.0 mode.</p> <p><b>Note:</b> Intel PTT can be used with Windows 8 or later operating system.</p>
	Security Chip	<ul style="list-style-type: none"> <li>• Active</li> <li>• <b>Inactive</b></li> <li>• Disabled</li> </ul>	If you select <b>Active</b> , the security chip is functional. If you select <b>Inactive</b> , the <b>Security Chip</b> option is visible, but the security chip is not functional. If you select <b>Disabled</b> , the <b>Security Chip</b> option is hidden and the security chip is not functional.
	Security Reporting Options		<p>This option is available when <b>Security Chip</b> is active. It is used to enable or disable the following Security Reporting Options:</p> <ul style="list-style-type: none"> <li>• <b>BIOS ROM String Reporting</b> (Windows 7) or <b>UEFI ROM String Reporting</b> (Windows 8): BIOS text string</li> <li>• <b>CMOS Reporting</b>: CMOS data</li> <li>• <b>NVRAM Reporting</b>: Security data stored in the Asset ID</li> <li>• <b>SMBIOS Reporting</b>: SMBIOS data</li> </ul>
	Clear Security Chip	<ul style="list-style-type: none"> <li>• <b>Enter</b></li> </ul>	<p>Clear the encryption key.</p> <p><b>Note:</b> This item is displayed only if you have selected <b>Active</b> for the <b>Security Chip</b> option.</p>
	Intel TXT Feature	<ul style="list-style-type: none"> <li>• <b>Disabled</b></li> <li>• Enabled</li> </ul>	<p>Enable or disable the Intel Trusted Execution Technology.</p> <p><b>Note:</b> This item is displayed only if you have selected <b>Active</b> for the <b>Security Chip</b> option.</p>
	Physical Presence for Provisioning	<ul style="list-style-type: none"> <li>• <b>Disabled</b></li> <li>• Enabled</li> </ul>	Enable or disable the confirmation message when you change the settings of the security chip.
	Physical Presence for Clear	<ul style="list-style-type: none"> <li>• Disabled</li> <li>• <b>Enabled</b></li> </ul>	Enable or disable the confirmation message when you clear the security chip.
<b>UEFI BIOS Update Option</b>	Flash BIOS Updating by End-Users	<ul style="list-style-type: none"> <li>• Disabled</li> <li>• <b>Enabled</b></li> </ul>	If you select <b>Enabled</b> , all users can update the UEFI BIOS. If you select <b>Disabled</b> , only the person who knows the supervisor password can update the UEFI BIOS.
	Secure RollBack Prevention	<ul style="list-style-type: none"> <li>• <b>Disabled</b></li> <li>• Enabled</li> </ul>	If you select <b>Disabled</b> , you can flash the older version UEFI BIOS.

Table 5. Security menu items (continued)

Menu item	Submenu item	Value	Comments
<b>Memory Protection</b>	Execution Prevention	<ul style="list-style-type: none"> <li>• Disabled</li> <li>• <b>Enabled</b></li> </ul>	Some computer viruses and worms cause memory buffers to overflow. By selecting <b>Enabled</b> you can protect your computer against attacks by such viruses and worms. If after choosing <b>Enabled</b> you find that a program does not run correctly, select <b>Disabled</b> and reset the setting.
	Virtualization	<ul style="list-style-type: none"> <li>• <b>Disabled</b></li> <li>• Enabled</li> </ul>	If you select <b>Enabled</b> , a Virtual Machine Monitor (VMM) can utilize the additional hardware capabilities provided by Intel Virtualization Technology.
	Intel VT-d Feature	<ul style="list-style-type: none"> <li>• <b>Disabled</b></li> <li>• Enabled</li> </ul>	Intel VT-d stands for Intel Virtualization Technology for Directed I/O. When enabled, a VMM can utilize the platform infrastructure for I/O virtualization.
<b>I/O Port Access</b>	Ethernet LAN	<ul style="list-style-type: none"> <li>• Disabled</li> <li>• <b>Enabled</b></li> </ul>	If you select <b>Enabled</b> , you can use the Ethernet LAN device.
	Wireless LAN	<ul style="list-style-type: none"> <li>• Disabled</li> <li>• <b>Enabled</b></li> </ul>	If you select <b>Enabled</b> , you can use the Wireless LAN connection.
	Wireless WAN	<ul style="list-style-type: none"> <li>• Disabled</li> <li>• <b>Enabled</b></li> </ul>	If you select <b>Enabled</b> , you can use the wireless WAN device.
	Bluetooth	<ul style="list-style-type: none"> <li>• Disabled</li> <li>• <b>Enabled</b></li> </ul>	If you select <b>Enabled</b> , you can use Bluetooth devices.
	USB Port	<ul style="list-style-type: none"> <li>• Disabled</li> <li>• <b>Enabled</b></li> </ul>	If you select <b>Enabled</b> , you can use the USB connectors.
	Memory Card Slot	<ul style="list-style-type: none"> <li>• Disabled</li> <li>• <b>Enabled</b></li> </ul>	If you select <b>Enabled</b> , you can use the memory card slots.
	Smart Card Slot	<ul style="list-style-type: none"> <li>• Disabled</li> <li>• <b>Enabled</b></li> </ul>	If you select <b>Enabled</b> , you can use the smart card slots.
	Integrated Camera	<ul style="list-style-type: none"> <li>• Disabled</li> <li>• <b>Enabled</b></li> </ul>	If you select <b>Enabled</b> , you can use the integrated camera.
	Microphone	<ul style="list-style-type: none"> <li>• Disabled</li> <li>• <b>Enabled</b></li> </ul>	If you select <b>Enabled</b> , you can use the microphones (internal, external, or line-in).
	Fingerprint Reader	<ul style="list-style-type: none"> <li>• Disabled</li> <li>• <b>Enabled</b></li> </ul>	If you select <b>Enabled</b> , you can use the fingerprint reader.
	NFC Device	<ul style="list-style-type: none"> <li>• Disabled</li> <li>• <b>Enabled</b></li> </ul>	If you select <b>Enabled</b> , you can use the NFC device.
<b>Internal Device Access</b>	Bottom Cover Tamper Detection	<ul style="list-style-type: none"> <li>• <b>Disabled</b></li> <li>• Enabled</li> </ul>	Enable or disable the tamper detection. If tamper is detected, Supervisor Password is required to boot the system. Bottom Cover Tamper Detection will not take effect unless Supervisor Password is enabled.

Table 5. Security menu items (continued)

Menu item	Submenu item	Value	Comments
<b>Anti-Theft</b>	Intel AT Module Activation	<ul style="list-style-type: none"> <li>• Disabled</li> <li>• <b>Enabled</b></li> <li>• Permanently Disabled</li> </ul>	<p>Enable or disable the UEFI BIOS interface to activate the Intel AT module, which is an optional anti-theft service from Intel.</p> <p><b>Note:</b> If you set the Intel AT module activation to <b>Permanently Disabled</b>, you will be unable to enable this setting again.</p>
	Intel AT Suspend	<ul style="list-style-type: none"> <li>• <b>Enter</b></li> </ul>	<p>This option is displayed only when the anti-theft function is activated.</p> <p>The Intel anti-theft suspend screen will be displayed at next boot to enter the suspend mode.</p>
	Computrace	<ul style="list-style-type: none"> <li>• Disabled</li> <li>• <b>Enabled</b></li> <li>• Permanently Disabled</li> </ul>	<p>Enable or disable the UEFI BIOS interface to activate the computrace module. Computrace is an optional monitoring service from Absolute Software.</p> <p><b>Note:</b> If you set the computrace module activation to <b>Permanently Disabled</b>, you will be unable to enable this setting again.</p>
<b>Secure Boot</b>	Secure Boot	<ul style="list-style-type: none"> <li>• <b>Disabled</b></li> <li>• Enabled</li> </ul>	<p>Enable or disable the UEFI Secure Boot feature. Select <b>Enable</b> to prevent unauthorized operating systems from running at boot time. Select <b>Disabled</b> to allow any operating systems to run at boot time.</p>
	Platform Mode	<ul style="list-style-type: none"> <li>• Setup Mode</li> <li>• <b>User Mode</b></li> </ul>	<p>Specify the system operating mode.</p>
	Secure Boot Mode	<ul style="list-style-type: none"> <li>• <b>Standard Mode</b></li> <li>• Custom Mode</li> </ul>	<p>Specify the Secure Boot mode.</p>
	Reset to Setup Mode		<p>This option is used to clear the current platform key and put the system into <b>Setup Mode</b>. You can install your own platform key and customize the Secure Boot signature databases in <b>Setup Mode</b>.</p> <p>Secure Boot mode will be set to <b>Custom Mode</b>.</p>
	Restore Factory Keys		<p>This option is used to restore all keys and certificates in Secure Boot databases to factory defaults. Any customized Secure Boot settings will be erased, and the default platform key will be re-established along with the original signature databases including certificate for Windows 8 operating system.</p>

## Startup menu

To change the startup settings of your computer, select the **Startup** tab from the ThinkPad Setup menu.

### Attention:

- After you change the startup sequence, ensure that you select a correct device during a copy, a save, or a format operation. Otherwise your data might be erased or overwritten.

- If you are using the BitLocker drive encryption, do not change the startup sequence. BitLocker drive encryption locks the computer from starting once detects the change of startup sequence.

To change the startup sequence temporarily so that the computer starts from a desired drive, do the following:

1. Turn off the computer.
2. Turn on the computer. When the ThinkPad logo is displayed, press F12.
3. Select the device that you want the computer to start from.

**Note:** The **Boot** menu will be displayed if the computer cannot start from any devices, or the operating system cannot be found.

The following table lists the **Startup** menu items. Default values are in **boldface**.

**Note:** Some items are displayed on the menu only if the computer supports the corresponding features.

Table 6. Startup menu items

Menu item	Value	Comments
<b>Boot</b>		Select the boot device when you press the power button to turn on the computer.
<b>Network Boot</b>		Select the boot device when the system wakes from LAN. If <b>Wake On LAN</b> is enabled, the network administrator can turn on all of the computers in a LAN remotely by use of network management software.
<b>UEFI/Legacy Boot</b>	<ul style="list-style-type: none"> <li>• <b>Both</b> <ul style="list-style-type: none"> <li>– <b>UEFI/Legacy Boot Priority</b> <ul style="list-style-type: none"> <li>– UEFI First</li> <li>– <b>Legacy First</b></li> </ul> </li> </ul> </li> <li>• UEFI Only</li> <li>• Legacy Only</li> </ul> <p><b>CSM Support</b> (for UEFI Only)</p> <ul style="list-style-type: none"> <li>• <b>Yes</b></li> <li>• No</li> </ul>	<p>Select system boot capability.</p> <ul style="list-style-type: none"> <li>• <b>Both:</b> Select priority of boot options between UEFI and Legacy.</li> <li>• <b>UEFI Only:</b> The system will boot from the UEFI enabled operating system.</li> <li>• <b>Legacy Only:</b> The system will boot from any operating system other than the UEFI enabled one.</li> </ul> <p><b>Note:</b> If you select <b>UEFI Only</b>, the system cannot boot from the bootable devices that do not have the UEFI enabled operating system.</p> <p>Compatibility Support Module (CSM) is required for booting the legacy operating system. If you select <b>UEFI Only</b>, <b>CSM Support</b> is selectable. For <b>Both</b> or <b>Legacy Only</b> mood, <b>CSM Support</b> is not selectable.</p>



Table 6. Startup menu items (continued)

Menu item	Value	Comments
<b>Boot Mode</b>	<ul style="list-style-type: none"> <li>• <b>Quick</b></li> <li>• Diagnostics</li> </ul>	<p>Screen during the POST:</p> <ul style="list-style-type: none"> <li>• <b>Quick:</b> The ThinkPad Logo screen is displayed.</li> <li>• <b>Diagnostics:</b> Text messages are displayed.</li> </ul> <p><b>Note:</b> You also can enter <b>Diagnostic</b> mode by pressing Esc during the POST.</p>
<b>Option Keys display</b>	<ul style="list-style-type: none"> <li>• Disabled</li> <li>• <b>Enabled</b></li> </ul>	If you select <b>Disabled</b> , the “To interrupt normal startup, press Enter.” message is not displayed during the POST.
<b>Boot Device List F12 Option</b>	<ul style="list-style-type: none"> <li>• Disabled</li> <li>• <b>Enabled</b></li> </ul>	If you select <b>Enabled</b> , the F12 key is recognized and the Boot Menu window is displayed.
<b>Boot Order Lock</b>	<ul style="list-style-type: none"> <li>• <b>Disabled</b></li> <li>• Enabled</li> </ul>	If you select <b>Enabled</b> , the boot priority order is locked for your future use.

## Restart menu

To exit the ThinkPad Setup program and restart the computer, select **Restart** from the ThinkPad Setup menu.

The following submenu items are displayed:

- **Exit Saving Changes:** Save the changes and restart the computer.
- **Exit Discarding Changes:** Discard the changes and restart the computer.
- **Load Setup Defaults:** Restore to the factory default settings.

**Note:** Enable **OS Optimized Defaults** to meet the Windows 8 certification requirements. When you change this setting, some other settings are changed automatically, such as **CSM Support**, **UEFI/Legacy Boot**, **Secure Boot**, and **Secure RollBack Prevention**.

- **Discard Changes:** Discard the changes.
- **Save Changes:** Save the changes.

## Updating the UEFI BIOS

The UEFI BIOS is the first program that the computer runs when the computer is turned on. The UEFI BIOS initializes the hardware components, and loads the operating system and other programs.

You can update the UEFI BIOS by starting your computer from a flash update optical disc or a flash update program running in the Windows environment. When you install a new program, a device driver, or hardware, you might be informed to update the UEFI BIOS.

For instructions on how to update the UEFI BIOS, go to:  
<http://www.lenovo.com/ThinkPadDrivers>

---

## Using system management

This topic is primarily intended for the network administrators.

Your computer is designed for manageability, so that you can redirect more resources to better meet your business objectives.

This manageability, known as Total Cost of Ownership (TCO), enables you to remotely operate client computers in the same way as you operate your own computer, such as turning on a client computer, formatting a hard disk drive, and installing a program.

Once the computer is configured and operational, you can manage it by using the software and the manageability features that are already integrated into the client computer and the network.

### **Desktop Management Interface**

The UEFI BIOS of your computer supports an interface called System Management BIOS (SMBIOS) Reference Specification, version 2.7.1. SMBIOS provides information about the hardware components of your computer. It is the responsibility of the UEFI BIOS to provide information about itself and the devices on the system board. This specification documents the standards for getting access to this BIOS information.

### **Preboot eXecution Environment**

The Preboot eXecution Environment (PXE) technology makes the computer more manageable by enabling the computer to start from a server. Your computer supports the personal computer functions that PXE requires. For example, with the appropriate LAN card, your computer can be started from the PXE server.

**Note:** The Remote Initial Program Load (RIPL or RPL) function cannot be used with your computer.

### **Wake on LAN**

The network administrator can turn on a computer from a management console by using the Wake on LAN feature.

When the Wake on LAN feature is enabled, many operations, such as data transfer, software updates, and Flash updates of the UEFI BIOS, can be done remotely without remote attendance. The updating process can perform after normal working hours and on weekends, so that the users are not interrupted during work, and the LAN traffic is kept to a minimum. It saves time and increases productivity.

**Note:** If the computer is turned on through Wake on LAN, the computer starts follow the **Network Boot** sequence.

### **Asset ID EEPROM**

The Asset ID EEPROM contains information about the computer configuration and the serial numbers of the key components. It also includes a number of blank fields where you can record information about the end users in your network.

## **Setting management features**

To enable a network administrator to remotely control your computer, set the following system-management features in the ThinkPad Setup program:

- Wake on LAN
- Network Boot sequence
- Flash update

**Note:** If a supervisor password has been set, you will be required to enter the supervisor password when you start the ThinkPad Setup program.

## Enabling or disabling the Wake on LAN feature

When the Wake on LAN feature is enabled and the computer is connected to a LAN, the network administrator can start the computer remotely from a management console, using a remote network-management program.

To enable or disable the Wake on LAN feature, do the following:

1. Start the ThinkPad Setup program. See “Using the ThinkPad Setup program” on page 101.
2. Select **Config → Network**. The **Network** submenu is displayed.
3. Select a corresponding option for the Wake on LAN feature.
4. Press F10. A Setup Confirmation window is displayed. Click **Yes** to save the configuration and exit the ThinkPad Setup program.

## Defining a Network Boot sequence

When the computer wakes on LAN, the computer boots from the device as specified on the **Network Boot** menu, and then follow the boot order list on the **Boot** menu.

To define a Network Boot sequence, do the following:

1. Start the ThinkPad Setup program. See “Using the ThinkPad Setup program” on page 101.
2. Select **Startup → Network Boot**. The boot device list is displayed.
3. Select a boot device to make it as the top boot priority.
4. Press F10. A Setup Confirmation window is displayed. Click **Yes** to save the configuration and exit the ThinkPad Setup program.

**Note:** You can press F9 to restore to the factory default settings.

## Checking the requirements for flash updates

A network administrator can update the programs on your computer from a management console, if the following requirements are met:

- The computer must be started over LAN.
- The computer must be engaged in the Preboot eXecution Environment (PXE).
- A network-management program must be installed on the computer of the network administrator.



---

## Chapter 9. Preventing problems

An important part of owning a ThinkPad notebook computer is maintenance. With proper care, you can avoid common problems. This chapter provides information that can help you keep your computer running smoothly.

- “General tips for preventing problems” on page 117
- “Making sure device drivers are current” on page 118
- “Taking care of your computer” on page 119

---

### General tips for preventing problems

This topic provides the following tips to help you prevent computing problems:

- If your computer is equipped with both a hard disk drive and an M.2 solid-state drive, you are not recommended to use the M.2 solid-state drive as a bootable device. The M.2 solid-state drive is designed and developed for the “cache” function purpose only. If you use the M.2 solid-state drive as a bootable device, its reliability is not guaranteed.
- Check the capacity of your hard disk drive from time to time. If the hard disk drive gets too full, the Windows operating system will slow down and might produce errors.

To check the hard disk drive capacity, do the following:

- Windows 7: Click **Start** → **Computer**.
- Windows 8: Open the File Explorer and click **Computer**.
- Empty your recycle bin on a regular basis.
- Use disk defragment tool regularly on your hard disk drive to improve data seek and read times.
- To free up disk space, uninstall unused programs.

**Note:** You also might want to look for program duplication or overlapping versions.

- Clean out your Inbox, Sent, and Trash folders from your e-mail client program.
- Back up your data at least once a week. If critical data is present, it is a good idea to perform a daily backup operation. Lenovo has many backup options available for your computer. Rewritable optical drives are available for most machines and are easily installed.
- Schedule system restore operations to take a system snapshot periodically. For more information about system restore, see Chapter 5 “Recovery overview” on page 59.
- Update device drivers and UEFI BIOS when needed.
- Profile your machine at <http://www.lenovo.com/support> to keep up to date with current drivers and revisions.
- Keep up to date for device drivers on other non-Lenovo hardware. You might want to read the device driver information release notes prior to updating for compatibility or known issues.
- Keep a log book. Entries might include major hardware or software changes, driver updates, minor issues you have experienced, and how you resolved the minor issues.
- If you ever need to run a recovery on your computer to return the preinstalled contents onto the machine, the following tips might help along the way:
  - Remove all external devices such as the printer, keyboard, and so on.
  - Make sure that your battery packs are charged and your computer has the ac power connected.
  - Access ThinkPad Setup and load the default settings.

- Restart the computer and start the recovery operation.
- If your computer uses discs as the recovery media, do not remove the disc from the drive until prompted to do so.
- For suspected hard disk drive issues, refer to “Diagnosing problems” on page 123 and run a diagnostic test for the drive before you call the Customer Support Center. If your computer does not start up, download the files to create a bootable self-test medium from <http://www.lenovo.com/hddtest>. Run the test and record any messages or error codes. If the test returns any failing error codes or messages, call the Customer Support Center with the codes or messages and the computer in front of you. A technician will assist you further.
- If required, you can find the contact information about the Customer Support Center for your country or region at <http://www.lenovo.com/support/phone>. When calling the Customer Support Center, make sure that you have your machine model type, serial number, and the computer in front of you. Also, if the computer is producing error codes, it is helpful to have the error screen on or the messages written down.

---

## Making sure device drivers are current

Device drivers are programs that contain instructions for the operating system about how to operate or “drive” a certain piece of hardware. Each hardware component on your computer has its own specific driver. If you add a new component, the operating system needs to be instructed on how to operate that piece of hardware. After you install the driver, the operating system can recognize the hardware component and understand how to use it.

**Note:** Because drivers are programs, like any other file on your computer, they are susceptible to corruption and might not perform correctly if corruption occurs.

It is not always necessary to download the latest drivers. However, you should download the latest driver for a component if you notice poor performance from that component or if you added a new component. This might eliminate the driver as the potential cause of a problem.

### Getting the latest drivers from the Web site

You can download and install updated device drivers from the Lenovo Web site by doing the following:

1. Go to <http://www.lenovo.com/ThinkPadDrivers>.
2. Select the entry for your computer and then follow the instructions on the screen to download and install necessary software.

### Getting the latest drivers using System Update

The System Update program helps you keep the software on your computer up-to-date. Update packages are stored on Lenovo servers and can be downloaded from the Lenovo Support Web site. Update packages can contain applications, device drivers, UEFI BIOS flashes, or software updates. When the System Update program connects to the Lenovo Support Web site, the System Update program automatically recognizes the machine type and model of your computer, the installed operating system, and the language of the operating system to determine what updates are available for your computer. The System Update program then displays a list of update packages and categorizes each update as critical, recommended, or optional to help you understand the importance. You have complete control of which updates to download and install. After you select the update packages you want, the System Update program automatically downloads and installs the updates without any further intervention from you.

The System Update program is preinstalled on your computer and is ready to run. The only prerequisite is an active Internet connection. You can start the program manually, or you can use the schedule feature to enable the program to search for updates automatically at specified intervals. You also can predefine scheduled updates to search by severity (critical updates, critical and recommended updates, or all updates) so the list you choose from contains only those update types that are of interest to you.

For more information about how to use the System Update program, refer to the help information system of the program.

---

## Taking care of your computer

Although your computer is designed to function reliably in normal work environments, you need to use common sense in handling it. By following the important tips in this topic, you will get the most use and enjoyment out of your computer.

### Be careful about where and how you work

- Store packing materials safely out of the reach of children to prevent the risk of suffocation from plastic bags.
- Keep your computer away from magnets, activated cellular phones, electrical appliances, or speakers (more than 13 cm or 5 inches).
- Avoid subjecting your computer to extreme temperatures (below 5°C/41°F or above 35°C/95°F).
- Some appliances, such as certain portable desktop fans or air purifiers, can produce negative ions. If a computer is close to such an appliance, and is exposed for an extended time to air containing negative ions, it might become electrostatically charged. Such a charge might be discharged through your hands when you touch the keyboard or other parts of the computer, or through connectors on I/O devices connected to the computer. Even though this kind of electrostatic discharge (ESD) is the opposite of a discharge from your body or clothing to the computer, it poses the same risk of a computer malfunction.

Your computer is designed and manufactured to minimize any effects of electrostatic charge. An electrostatic charge above a certain limit, however, can increase the risk of ESD. Therefore, when using the computer close to an appliance that can produce negative ions, give special attention to the following:

- Avoid directly exposing your computer to the air from an appliance that can produce negative ions.
- Keep your computer and peripherals as far as possible from such an appliance.
- Wherever possible, ground your computer to facilitate safe electrostatic discharge.

**Note:** Not all such appliances cause a significant electrostatic charge.

### Be gentle with your computer

- Avoid placing any objects (including paper) between the display and the keyboard or the palm rest.
- Your computer display is designed to be opened and used at an angle slightly greater than 90 degrees. Do not open the display beyond 180 degrees, as this might damage the computer hinge.
- Do not turn your computer over while the ac power adapter is plugged in. This could break the adapter plug.

### Carry your computer properly

- Before moving your computer, be sure to remove any media, turn off attached devices, and disconnect cords and cables.
- When picking up your open computer, hold it by the bottom. Do not pick up or hold your computer by the display.

### Handle storage media and drives properly

- When installing the hard disk drive, or solid-state drive, follow the instructions shipped with your hardware, and apply pressure only where needed on the device.
- Turn off your computer before you replace the hard disk drive or solid-state drive.
- After you replace the primary hard disk drive or solid-state drive, reattach the cover of the drive slot.

- Store your external and removable hard disk drive or optical drives in the appropriate containers or packaging when they are not being used.
- Before you install a memory card such as an SD card, SDHC card, SDXC card, and a MultiMediaCard, touch a metal table or a grounded metal object. This action reduces any static electricity from your body. The static electricity could damage the device.
- While transferring data to or from a flash media card, such as an SD card, do not put your computer into sleep or hibernation mode before the data transfer is complete; otherwise, your data could become damaged.

### **Take care in setting passwords**

- Remember your passwords. If you forget a supervisor or hard disk password, Lenovo will not reset it, and you might have to replace your system board, or hard disk drive or solid-state drive.

### **Taking care of the fingerprint reader**

The following actions could damage the fingerprint reader or cause it not to work properly:

- Scratching the surface of the fingerprint reader with a hard, pointed object.
- Scraping the surface of the fingerprint reader with your fingernail or anything hard.
- Using or touching the fingerprint reader with a dirty finger.

If you notice any of the following conditions, gently clean the surface of the fingerprint reader with a dry, soft, lint-free cloth:

- The surface of the fingerprint reader is dirty or stained.
- The surface of the fingerprint reader is wet.
- The fingerprint reader often fails to enroll or authenticate your fingerprint.

### **Register your computer**

- Register your ThinkPad computer with Lenovo at <http://www.lenovo.com/register>. For more information, see “Registering your computer” on page 19.

### **Be sure not to modify your computer**

- Only an authorized ThinkPad repair technician should disassemble and repair your computer.
- Do not modify or tape the latches to keep the display open or closed.

## **Cleaning the cover of your computer**

Occasionally clean your computer by doing the following:

1. Prepare a mixture of a gentle kitchen-use detergent. The detergent must not contain abrasive powder or strong chemicals such as acid or alkaline. Use five parts water to one part detergent.
2. Absorb the diluted detergent into a sponge.
3. Squeeze excess liquid from the sponge.
4. Wipe the cover with the sponge, using a circular motion and taking care not to let any excess liquid drip.
5. Wipe the surface to remove the detergent.
6. Rinse the sponge with clean running water.
7. Wipe the cover with the clean sponge.
8. Wipe the surface again with a dry, soft, lint-free cloth.
9. Wait for the surface to dry completely and remove any fibers from the cloth.



### **Cleaning your computer keyboard**

To clean the computer keyboard, do the following:

1. Apply some isopropyl rubbing alcohol to a soft, dust-free cloth.

**Note:** Avoid spraying cleaner directly onto the keyboard.

2. Wipe each keytop surface with the cloth. Wipe the keys one by one; if you wipe several keys at a time, the cloth might hook onto an adjacent key and possibly damage it. Make sure that no liquid drips onto or between the keys.
3. Allow to dry.
4. To remove any crumbs or dust from beneath the keys, you can use a camera blower with a brush or cool air from a hair dryer.

### **Cleaning your computer display**

To clean the computer display, do the following:

1. Gently wipe the display with a dry, soft lint-free cloth. If you see a scratchlike mark on your display, it might be a stain transferred from the keyboard or the TrackPoint pointing stick when the cover was pressed from the outside.
2. Wipe or dust the stain gently with a soft, dry cloth.
3. If the stain remains, moisten a soft, lint-free cloth with water or a 50-50 mixture of isopropyl alcohol and water that does not contain impurities.

**Note:** Avoid spraying cleaner directly onto the keyboard.

4. Wring out as much of the liquid as you can.
5. Wipe the display again; do not let any liquid drip into the computer.
6. Be sure to dry the display before closing it.



---

## Chapter 10. Troubleshooting computer problems

This chapter provides information on what to do if you experience a problem with your computer.

- “Diagnosing problems” on page 123
- “Troubleshooting” on page 123

---

### Diagnosing problems

If you experience problems with your computer, use the Lenovo Solution Center program as a starting point for solving them.

The Lenovo Solution Center program enables you to troubleshoot and resolve computer problems. It combines diagnostic tests, system information collection, security status, and support information, along with hints and tips for maximum system performance.

#### Notes:

- The Lenovo Solution Center program also is available for download at:  
<http://www.lenovo.com/diags>.
- If you are using other Windows operating system rather than Windows 7 and Windows 8, you can find the latest information about diagnostics for your computer at:  
<http://www.lenovo.com/diagnose>

If your computer is installed with the Windows 7 operating system, when you are setting up your computer, the Lenovo Solution Center program prompts you to create recovery media, which you can use to restore the hard disk drive to the factory default state. For more information, see “Performing backup and recovery operations” on page 60.

To run the Lenovo Solution Center program, see “Lenovo programs” on page 14.

For additional information, refer to the Lenovo Solution Center help system.

**Note:** If you are unable to isolate and repair the problem yourself after running Lenovo Solution Center program, save and print the log files created by the program. You will need the log files when you speak to a Lenovo technical support representative.

---

### Troubleshooting

If your computer has an error, it typically displays a message or an error code, or a beep sounds when you turn it on. When you experience a problem, refer to the corresponding sections in this topic to try to solve the problem by yourself.

#### Computer stops responding

**Print these instructions now and keep the instructions with your computer for reference later.**

If your computer is completely unresponsive (you cannot use the TrackPoint pointing device or the keyboard), do the following:

1. Press and hold the power button for four seconds or more to turn off the computer.
  - If the computer is turned off, restart the computer by pressing the power button. If the computer does not turn on, continue with step 2.

- If you cannot turn off your computer by pressing and holding the power button, remove all sources of power from the computer and reset the system by inserting a straightened paper clip into the emergency reset hole. To locate the reset hole, refer to “Bottom view” on page 6. After the computer is off, restart the computer by pressing the power button. If the computer does not turn on, continue with step 3.
2. While the computer is off, remove all sources of power (the external battery pack and the ac power adapter) from the computer and reset the system by inserting a straightened paper clip into the emergency reset hole. Reattach the ac power adapter but do not install the external battery pack. Restart the computer. If the computer does not turn back on, continue with step 3.

**Note:** If the computer starts up and enters the Windows environment, use the proper shutdown procedure to turn off the computer. Once the computer is off, install the external battery pack and restart the computer. If the computer does not start with the external battery pack installed, remove the external battery pack and repeat step 2. If the computer starts with ac power but does not start when ac power is removed, call the Customer Support Center for support.

3. Remove all external devices that are attached to your computer (keyboard, mouse, printer, scanner, and so on). Repeat step 2. If step 2 is unsuccessful, call the Customer Support Center and a Customer Support Specialist will assist you.

## Spills on the keyboard

With a mobile computer, there are increased chances of spilling liquids on the keyboard. Because most liquids conduct electricity, liquid spilled on the keyboard could create numerous short circuits, potentially causing irreparable damage to your computer.

### If you spill something on your computer:

**Attention:** Be sure that no liquid creates a short circuit between you and the ac power adapter (if in use). Although you might lose some data or work by turning off the computer immediately, leaving the computer on might make your computer unusable.

1. Carefully unplug the ac power adapter immediately.
2. Turn off the computer immediately. If the computer does not turn off, reset the system by inserting one end of a needle or a straightened paper clip into the emergency reset hole. To locate the reset hole, refer to “Bottom view” on page 6. The more quickly you stop the current from passing through the computer the more likely you will reduce damage from short circuits.
3. Wait until you are certain that all the liquid is dry before turning on your computer.

**Note:** If you want to replace your keyboard, you can purchase a new one.

## Error messages

- **Message:** 0177: Bad SVP data, stop POST task.  
**Solution:** Checksum of the supervisor password in the EEPROM is not correct. The system board should be replaced. Have the computer serviced.
- **Message:** 0183: Bad CRC of Security Settings in EFI Variable. Enter ThinkPad Setup.  
**Solution:** Checksum of the Security settings in the EFI Variable is not correct. Enter ThinkPad Setup to check security settings, Press F10, and then press Enter to restart the system. If you still have a problem, have the computer serviced.
- **Message:** 0187: EAIA data access error  
**Solution:** The access to EEPROM is failed. Have the computer serviced.
- **Message:** 0188: Invalid RFID Serialization Information Area

**Solution:** The EEPROM checksum is not correct (block # 0 and 1). The system board should be replaced, and the box serial number needs to be reinstalled. Have the computer serviced.

- **Message:** 0189: Invalid RFID configuration information area

**Solution:** The EEPROM checksum is not correct (block # 4 and 5). The system board should be replaced, and the UUID needs to be reinstalled. Have the computer serviced.

- **Message:** 0190: Critical low-battery error

**Solution:** The computer turned off, because the battery is low. Connect the ac power adapter to the computer and charge the battery.

- **Message:** 0191: System Security - Invalid remote change requested

**Solution:** The system configuration change has failed. Confirm the operation and try again. To clear the error, enter ThinkPad Setup.

- **Message:** 0199: System Security - Security password retry count exceeded.

**Solution:** This message is displayed if you enter a wrong supervisor password more than three times. Confirm the supervisor password and try again. To clear the error, enter ThinkPad Setup.

- **Message:** 1802: Unauthorized network card is plugged in - Power off and remove the network card.

**Solution:** The wireless network card is not supported on this computer. Remove it.

- **Message:** 1820: More than one external fingerprint readers are attached.

**Solution:** Power off and remove all but the reader that you set up within your main operating system.

- **Message:** 2100: Detection error on HDD0 (Main HDD)

**Solution:** The hard disk is not working. Have the hard disk serviced.

- **Message:** 2101: Detection error on HDD2 (M.2 SATA)

**Solution:** The M.2 SATA device is not working. Have the M.2 SATA device serviced.

- **Message:** 2102: Detection error on HDD2 (M.2 SATA)

**Solution:** The M.2 SATA device is not working. Have the M.2 SATA device serviced.

- **Message:** 2110: Read error on HDD0 (Main HDD)

**Solution:** The hard disk is not working. Have the hard disk serviced.

- **Message:** 2111: Read error on HDD2 (M.2 SATA)

**Solution:** The M.2 SATA device is not working. Have the M.2 SATA device serviced.

- **Message:** 2112: Read error on HDD2 (M.2 SATA)

**Solution:** The M.2 SATA device is not working. Have the M.2 SATA device serviced.

- **Message:** 2200: Machine Type and Serial Number are invalid.

**Solution:** Machine Type and Serial Number are invalid. Have the computer serviced.

- **Message:** 2201: Machine UUID is invalid.

**Solution:** Machine UUID is invalid. Have the computer serviced.

- **Message:** Fan error

**Solution:** Cooling fan has failed. Shut down the computer immediately and have the computer serviced.

- **Message:** Thermal sensing error

**Solution:** The thermal sensor has problem. Shut down the computer immediately and have the computer serviced.

## Errors without messages

- **Problem:** My screen keeps blanking when I do not want it to.

**Solution:** If your computer is preinstalled with the Windows 7 operating system, you can disable any system timers, such as the LCD turn-off timer or the blank timer by doing the following:

1. Start Power Manager.
2. Click the **Power plan** tab, and then select **Maximum Performance** from the predefined power plans.

- **Problem:** When I turn on the computer, nothing is displayed on the screen and the computer does not beep while starting up.

**Note:** If you are not sure whether you heard any beeps, turn off the computer by pressing and holding the power button for four seconds or more. Then turn on the computer and listen again.

**Solution:** Make sure that:

- The ac power adapter is connected to the computer and the power cord is plugged into a working electrical outlet.
- The computer is turned on. (Press the power button again for confirmation.)
- The brightness level of the screen is appropriately set.

If a power-on password is set, press any key to display the prompt for the power-on password and then type the correct password and press **Enter**.

If these items are correctly set, and the screen remains blank, have the computer serviced.

- **Problem:** When I turn on the computer, only a white cursor is displayed on a blank screen.

**Solution:** If you have modified a partition on your hard disk drive by using partition software, information about that partition, or the master boot record might have been destroyed.

Do the following to try to solve the problem:

1. Turn off the computer, and then turn it on again.
2. If you still see only the cursor on the screen, do the following:
  - If you have used partition software, examine the partition on the hard disk drive by using the software, and recover the partition if required.
  - Use the recovery solutions to restore the system to the factory default state.

If the problem persists, have the computer serviced.

- **Problem:** My screen goes blank while the computer is on.

**Solution:** Your screen saver or power management might have been enabled. Do one of the following:

- Touch the TrackPoint pointing device or the trackpad, or press a key to exit the screen saver.
- Press the power button to resume the computer from sleep or hibernation mode.

## Beep errors

Table 7. Beep errors

Problem	Solution
One short beep, pause, three short beeps, pause, three more short beeps, and one short beep	Have the computer serviced.
One long and two short beeps	The video function has a problem. Have the computer serviced.

Table 7. Beep errors (continued)

Problem	Solution
Four cycles of four short beeps	Shut down the computer immediately and have the computer serviced.
Five short beeps	The system board has a problem. Have the computer serviced.

## Memory module problems

**Print these instructions now and keep the instructions with your computer for reference later.**

If your memory module is not operating properly, check the following items:

1. Verify that the memory module is installed and seated correctly in your computer.  
It might be necessary to remove all added memory modules to test the computer with only the factory-installed memory modules, and then reinstall the memory module one at a time to ensure a proper connection.
2. Check for error messages during startup.  
Follow the appropriate corrective actions for power-on self-test (POST). See “Error messages” on page 124.
3. Verify that the latest UEFI for your model has been installed.
4. Verify the proper memory configuration and compatibility including the maximum memory size and the memory speed.
5. Run diagnostic programs. See “Diagnosing problems” on page 123.

## Networking problems

The following are the most common networking problems.

### Ethernet problems

- **Problem:** The computer cannot connect to the network.

**Solution:** Make sure that:

- The cable is installed correctly.

The network cable must be securely connected both to the Ethernet connector of your computer and to the RJ45 connector of the hub. The maximum allowable distance from the computer to hub is 100 meters. If the cable is connected and the distance is within acceptable limits but the problem persists, try a different cable.

- You are using the correct device driver. To install the correct driver, do the following:

1. Open Control Panel and click **Hardware and Sound → Device Manager**. If you are prompted for an administrator password or confirmation, type the password or provide confirmation.
2. If the exclamation mark ! is displayed next to the adapter name under **Network adapters**, you might not be using the correct driver or the driver might have been disabled. To update the driver, right-click the highlighted adapter.
3. Click **Update Driver Software**, and then follow the instructions on the screen.

- The switch port and the adapter have the same duplex setting.

If you configured the adapter for full duplex, make sure that the switch port also is configured for full duplex. Setting wrong duplex mode can degrade performance, cause data loss, or result in lost connections.

- You have installed all networking software that is necessary for your network environment.  
Check with your LAN administrator for the necessary networking software.

- **Problem:** The adapter stops working for no apparent reason.

**Solution:** The network driver files might be corrupt or missing. Update the driver by referring to the previous solution for the procedure to make sure that the correct device driver is installed.

- **Problem:** My computer is a Gigabit Ethernet model and I use a speed of 1000 Mbps, but the connection fails or errors occur.

**Solution:**

- Use Category 5 wiring and make sure that the network cable is securely connected.
- Connect to a 1000 BASE-T hub/switch (not 1000 BASE-X).

- **Problem:** The Wake On LAN feature is not working.

**Solution:** Ensure that Wake On LAN is enabled in ThinkPad Setup. If it is, check with your LAN administrator for the necessary settings.

- **Problem:** My computer is a Gigabit Ethernet model, but the computer cannot connect to the network at 1000 Mbps. Instead, it connects at 100 Mbps.

**Solution:**

- Try another cable.
- Make sure that the link partner is set to auto-negotiate.
- Make sure that the switch is 802.3ab-compliant (gigabit over copper).

## A wireless LAN problem

**Problem:** I cannot connect to the network using the built-in wireless network card.

**Solution:** Make sure that:

- Your wireless LAN driver is the latest version.
- Your computer is within range of a wireless access point.
- The wireless radio is enabled.

**Note:** If you are using the Windows 7 operating system, click **Show hidden icons** on the taskbar. The Access Connections icon is displayed. For more information about the icon, refer to the Access Connections help information system.

For the Windows 7 operating system, check the Network Name (SSID) and your encryption information. Use the Access Connections program to verify this case-sensitive information.

## A wireless WAN problem

**Problem:** A message is displayed indicating that an unauthorized WAN card is installed.

**Solution:** The WAN card is not supported on this computer. Remove the WAN card.

**Note:** Some models do not have a wireless WAN card.

## Bluetooth problems

**Note:** Check your connection anytime and make sure that no other Bluetooth-enabled device is searching for the device to which you want to connect. Simultaneous searching is not allowed in the Bluetooth connection.



- **Problem:** Sound does not come from the Bluetooth headset/headphone but comes from the local speaker even though the Bluetooth headset/headphone is connected using a Headset profile or AV profile.

**Solution:** Do the following:

1. Exit the application that uses the sound device (for example, Windows Media Player).
2. Open Control Panel and click **Hardware and Sound → Sound → Playback**.
3. If you are using a Headset profile, select **Bluetooth Hands-free Audio** and click the **Set Default** button. If you are using an AV profile, select **Stereo Audio** and click the **Set Default** button.
4. Click **OK** to close the Sound window.

- **Problem:** PIM items sent from the Windows 7 operating systems cannot be received correctly into the address book of any other Bluetooth-enabled device.

**Solution:** The Windows 7 operating system sends PIM items in XML format, but most Bluetooth-enabled devices handle PIM items in vCard format. If another Bluetooth-enabled device can receive a file through Bluetooth, a PIM item sent from the Windows 7 might be saved as a file with the extension .contact.

## Problems with the keyboard and other pointing devices

The following are the most common problems with keyboards and other pointing devices.

### TrackPoint pointing device problems

- **Problem:** The pointer drifts when the computer is turned on or after it resumes normal operation.

**Solution:** The pointer might drift when you are not using the TrackPoint pointing device during normal operation. This is a normal characteristic of the TrackPoint pointing device and is not a defect. Pointer drifting might occur for several seconds under the following conditions:

- When the computer is turned on
- When the computer resumes normal operation
- When the TrackPoint pointing device is kept pressed for a long time
- When the temperature changes

- **Problem:** The TrackPoint pointing device or trackpad does not work.

**Solution:** Ensure that the TrackPoint pointing device or trackpad is enabled in the Mouse Properties window.

### Keyboard problems

- **Problem:** All or some keys on the keyboard do not work.

**Solution:** If an external numeric keypad is connected:

1. Turn off the computer.
2. Remove the external numeric keypad.
3. Turn on the computer and try using the keyboard again.

If the keyboard problem is resolved, carefully reconnect the external numeric keypad and the external keyboard. Make sure that you have seated the connectors correctly.

If the problem persists, make sure that the correct device driver is installed by doing the following:

1. Open **Control Panel**. Change the view of Control Panel from Category to Large icons or Small icons.
2. Click **Keyboard**.
3. Select the **Hardware** tab. In the **Device Properties** pane, make sure that you see this message:  
Device Status: This device is working properly.

If keys on the keyboard still do not work, have the computer serviced.

- **Problem:** All or some keys on the external numeric keypad do not work.

**Solution:** Make sure that the external numeric keypad is correctly connected to the computer.

## Problems with the display and multimedia devices

This topic includes the most common problems with displays and multimedia devices, including the computer display, the external monitor, audio devices, and the optical drive.

### Computer screen problems

- **Problem:** The screen is blank.

**Solution:** Do the following:

- Press F7 to bring up the image.
- If you are using the ac power adapter, or using the batteries and the battery gauge shows that the batteries are not depleted, press F6 to make the screen brighter.
- If your computer is in sleep mode, press power button to resume from the sleep mode.
- If the problem persists, follow the solution for the following problem.

- **Problem:** The screen is unreadable or distorted.

**Solution:** Make sure that:

- The display device driver is installed correctly.
- The screen resolution and color quality are correctly set.
- The monitor type is correct.

To check these settings, do the following:

1. Right-click on the desktop, and click **Personalize**.
2. Click **Display** at the left.
3. Select **Change display settings**. Check whether the screen resolution is correctly set.
4. Click **Advanced Settings**.
5. Click the **Adapter** tab. Ensure that the correct device driver name is shown in the adapter information window.

**Note:** The device driver name depends on the video chip that has been installed on your computer.

6. Click the **Properties** button. If you are prompted for an administrator password or confirmation, type the password or provide confirmation. Check the **Device status** box and make sure that the device is working correctly. If not, click the **Troubleshoot** button and follow the instructions on the screen.
7. Click the **Monitor** tab. Ensure that the correct device driver name is shown in the adapter information window.
8. Click the **Properties** button. If you are prompted for an administrator password or confirmation, type the password or provide confirmation. Check the **Device status** box and make sure that the device is working correctly. If not, click the **Troubleshoot** button and follow the instructions on the screen.
9. Click the **Color Management** tab. Check whether the color quality is correctly set, and ensure that the other information also is correct. If you are prompted for an administrator password or confirmation, type the password or provide confirmation. Check the Device status box and ensure that the device is working correctly. If not, click the **Troubleshoot** button and follow the instructions on the screen.

- **Problem:** Incorrect characters are displayed on the screen.

**Solution:** Did you install the operating system or program correctly? If they are installed and configured correctly, have the computer serviced.

- **Problem:** The screen stays on even after you turn off your computer.  
**Solution:** Press and hold the power button for four seconds or more to turn off your computer; then turn it on again.
- **Problem:** Missing, discolored, or bright dots appear on the screen every time you turn on your computer.  
**Solution:** This is an intrinsic characteristic of the TFT technology. Your computer display contains multiple thin-film transistors (TFTs). A small number of missing, discolored, or bright dots on the screen might exist all the time.

## External monitor problems

- **Problem:** The external monitor is blank.  
**Solution:** To bring up the image, press F7 and select the desired monitor. If the problem persists, do the following:
  1. Connect the external monitor to another computer to make sure that it works.
  2. Reconnect the external monitor to your computer.
  3. Refer to the manual shipped with the external monitor to check the resolutions and refresh rates that are supported.
    - If the external monitor supports the same resolution as the computer display or a higher resolution, view output on the external monitor or on both the external monitor and the computer display.
    - If the external monitor supports a lower resolution than the computer display, view output on the external monitor only. (If you view output on both the computer display and the external monitor, the external monitor screen will be blank or distorted.)
- **Problem:** You cannot set a higher resolution than the present one on your external monitor.  
**Solution:** Make sure that the monitor type and other information is correct. If necessary, update the monitor driver. See “Setting the external monitor type” on page 36.
- **Problem:** The screen is unreadable or distorted.  
**Solution:** Make sure that:
  - The monitor information is correct and the appropriate monitor type is selected. Refer to the solution to the above problem.
  - Make sure that an appropriate refresh rate is selected by doing the following:
    1. Connect the external monitor to the monitor connector, and then connect the monitor to an electrical outlet.
    2. Turn on the external monitor and the computer.
    3. Right-click on the desktop, and click **Screen resolution**.
      - Note:** If your computer cannot detect the external monitor, click the **Detect** button.
    4. Click the icon for the desired monitor (the **Monitor-2** icon is for the external monitor).
    5. Click **Advanced Settings**.
    6. Click the **Monitor** tab.
    7. Select the correct screen refresh rate.
- **Problem:** Wrong characters are displayed on the screen.  
**Solution:** Did you follow the correct procedure when installing the operating system or program? If you did, have the external monitor serviced.
- **Problem:** The Extend desktop function does not work.  
**Solution:** Enable the Extend desktop function. See “Using dual displays” on page 38.

- **Problem:** If you use the Extend desktop function, you cannot set a higher resolution or higher refresh rate on the secondary display.  
**Solution:** Change the resolution and the color depth to lower settings for the primary display.
- **Problem:** Display switching does not work.  
**Solution:** If you use the Extend desktop function, disable it, and change the display output location. If a DVD movie or a video clip is playing, stop the playback, close the program, and then change the display output location.
- **Problem:** The screen position on the external monitor is incorrect when that monitor is set for a high resolution.  
**Solution:** Sometimes, when you use a high resolution such as 1600x1200, the image is shifted to left or right on the screen. To correct this, first make sure that your external monitor supports the display mode (the resolution and the refresh rate) that you have set. If it does not, set a display mode that the monitor supports. If it does support the display mode you have set, go to the setup menu for the monitor itself and adjust the settings there. Usually the external monitor has buttons for access to the setup menu. For more information, see the documentation that comes with the monitor.

## Audio problems

- **Problem:** Wave or MIDI sound does not play correctly.  
**Solution:** Make sure that the built-in audio device is configured correctly.
  1. Open **Control Panel**.
  2. Click **Hardware and Sound**.
  3. Click **Device Manager**. If you are prompted for an administrator password or confirmation, type the password or provide confirmation.
  4. Double-click **Sound, video and game controllers**.
  5. Make sure that the Realtek HD Audio driver is enabled and configured correctly:
- **Problem:** Sound does not come from a headphone or a speaker, or your computer cannot record sounds.  
**Solution:** To switch from one device to another (for example, from a speaker to a headphone, or from an external microphone to a built-in microphone), do the following:
  1. Open Control Panel and click **Hardware and Sound**.
  2. Click the **Realtek HD Manager** icon.
  3. Make sure that you are in MULTI-STREAM mode in the Device advanced settings window.
  4. In the Volume Mixer window, select the device you want—for example, speakers.
  5. Play any sound via a music program (for example, Windows Media Player). Make sure that sound comes from speakers now.
  6. Then, if you would like to switch to a headphone, close the music program.
  7. Go to the Volume Mixer window. Then select another device, which is now the headphone.
  8. Play any sound via the music program. Make sure that sound comes from a headphone attached directly to the system.

For more information, refer to the help information system of **Realtek HD Manager**.

**Note:** In the Volume Mixer window of **Realtek HD Manager**, a check mark by the entry for a device, such as speakers for a playback device, or a built-in microphone for a recording device, shows that the device has been selected.

- **Problem:** Recordings made using the microphone input are not loud enough.  
**Solution:** Make sure that the Microphone Boost function is turned on and set by doing the following:
  1. Open Control Panel and click **Hardware and Sound**.

2. Click **Hardware and Sound**.
3. Click **Sound**.
4. Click the **Recording** tab in the Sound window.
5. Select **Microphone**, and click the **Properties** button.
6. Click the **Levels** tab, and move the Microphone Boost slider upwards.
7. Click **OK**.

**Note:** For more information about controlling volume, see the Windows online help.

- **Problem:** A volume or balance slider cannot be moved.

**Solution:** The slider might be grayed out. This means that its position is fixed by the hardware and cannot be changed.

- **Problem:** The volume sliders do not stay in place when some audio programs are used.

**Solution:** It is normal for the sliders to change position when certain sound programs are used. The programs are aware of the settings in the Volume Mixer window and are allowed to change the settings themselves. An example is the Windows Media Player. Usually the program has sliders available to control the sound from within the program.

- **Problem:** The balance slider cannot completely mute one channel.

**Solution:** The control is designed to compensate for minor differences in balance and does not completely mute either channel.

- **Problem:** The sound cannot be turned off completely even if you set the Master volume control at minimum.

**Solution:** You still can hear some sound even though you have set the Volume Mixer control at minimum. To turn off the sound completely, press the speaker mute button.

- **Problem:** When you connect a headphone to your computer while playing sound, a speaker does not produce sound.

**Solution:** Once the headphone is attached, the streaming is automatically redirected to it. If you want to listen to sound from the speakers again, be sure to set those speakers as the default device. For more information, see the help information system for Realtek HD Audio.

## Fingerprint reader problems

- **Problem:** The surface of the reader is dirty, stained, or wet.

**Solution:** Gently clean the surface of the reader with a dry, soft, lint-free cloth.

- **Problem:** The reader often fails to enroll or authenticate your fingerprint.

**Solution:** If the surface of the reader is dirty, stained, or wet, gently clean the surface of the reader with a dry, soft, lint-free cloth.

For tips on how to maintain the fingerprint reader, see “Using the fingerprint reader” on page 53.

## Battery and power problems

This topic contains instructions on troubleshooting batteries and power problems.

### Battery problems

- **Problem:** The batteries cannot be fully charged in the standard charge time when the computer is powered off.

**Solution:** The batteries might be over-discharged. Do the following:

1. Turn off the computer.

2. Connect the ac power adapter to the computer and let it charge.

If a quick charger is available, use it to charge the over-discharged batteries.

If the batteries cannot be fully charged in 24 hours, call Lenovo Customer Service Center to have it serviced.

- **Problem:** Your computer shuts down before the battery status icon shows empty, or your computer operates after the battery status icon shows empty.

**Solution:** Discharge and recharge the batteries.

- **Problem:** The operating time for fully charged batteries is short.

**Solution:** Discharge and recharge the batteries. If your battery operating time is still short, call Lenovo Customer Service Center to have it serviced.

- **Problem:** The computer does not operate with fully charged batteries.

**Solution:** The surge protector in the batteries might be active. Turn off the computer for one minute to reset the protector; then turn on the computer again.

- **Problem:** The batteries cannot be charged.

**Solution:** You cannot charge the batteries when they are too hot. Turn off the computer and allow them to cool to room temperature. After they cool, recharge the batteries. If they still cannot be charged, call Lenovo Customer Service Center to have them serviced.

## An ac power adapter problem

**Problem:** The ac power adapter is connected to the computer and the working electrical outlet, but the power adapter (power plug) icon is not displayed in the Windows notification area. Also the ac power indicator does not light up.

**Solution:** Do the following:

1. Make sure that the connection of the ac power adapter is correct. For instructions on connecting the ac power adapter, see *Safety, Warranty, and Setup Guide* that comes with your computer.
2. If the connection of the ac power adapter is correct, turn off the computer, then disconnect the ac power adapter.
3. Reconnect the ac power adapter, then turn on the computer.
4. If the power adapter icon still is not displayed in the Windows notification area, have the ac power adapter and your computer serviced.

## Power problems

**Print these instructions now and keep it with your computer for reference later.**

**If your computer is getting no power at all, check the following items:**

1. Verify the power button. Refer to “Status indicators” on page 8. The power button is illuminated whenever the computer is on.
2. Check all power connections. Remove any power strips and surge protectors to connect the ac power adapter directly to the ac power outlet.
3. Inspect the ac power adapter. Check for any physical damage, and ensure that the power cable is firmly attached to the adapter brick and the computer.
4. Verify the ac power source is working by attaching another device to the outlet.

**If your computer does not run on battery power, check the following items:**

1. If the batteries run out of power, attach ac power adapter to recharge the battery.

2. If the batteries are charged but the computer does not run, call Lenovo Customer Service Center to have it serviced.

## A power button problem

**Problem:** The system does not respond, and you cannot turn off the computer.

**Solution:** Turn off the computer by pressing and holding the power button for four seconds or more. If the system is still not reset, remove the ac power adapter and reset the system by inserting one end of a needle or a straightened paper clip into the emergency reset hole. To locate the emergency reset hole, refer to “Bottom view” on page 6.

## Boot problems

Print these instructions now and keep them with your computer for reference later.

If you receive an error message before the operating system loads, follow the appropriate corrective actions for power-on self-test (POST) error messages. See “Error messages” on page 124.

If you receive an error message while the operating system is loading the desktop configuration after the POST is completed, check the following items:

1. Go to the Lenovo Support Web site at <http://www.lenovo.com/support> and search for the error message.
2. Go to the Microsoft Knowledge Base homepage at <http://support.microsoft.com/> and search for the error message.

## Sleep and hibernation problems

- **Problem:** The computer enters sleep mode unexpectedly.

**Solution:** If the microprocessor overheats, the computer automatically enters sleep mode to allow the computer to cool and to protect the microprocessor and other internal components. Check the settings for sleep mode.

- **Problem:** The computer enters sleep mode immediately after the power-on self-test.

**Solution:** Ensure that:

- The batteries are charged.
- The operating temperature is within the acceptable range. Refer to “Operating environment” on page 13.

If the batteries are charged and the temperature is within range, have the computer serviced.

- **Problem:** A critical low-battery error occurs, and the computer immediately turns off.

**Solution:** The battery power is getting low. Connect the ac power adapter to the computer and plug it into an electrical outlet.

- **Problem:** The computer display remains blank after you press Fn to return from sleep mode.

**Solution:** Check whether an external monitor was disconnected or turned off while the computer was in sleep mode. If you disconnected or turned off the external monitor, connect it or turn it on before resuming the computer from the sleep mode. When resuming the computer from the sleep mode without attaching the external monitor or turning it on, and the computer display remains blank, press F6 to bring up the computer display.

- **Problem:** The computer does not return from sleep mode, or the system status indicator (illuminated ThinkPad logo) blinks slowly and the computer does not work.

**Solution:** If the system does not return from sleep mode, it might have entered sleep or hibernation mode automatically because the batteries are depleted. Check the system status indicator (illuminated ThinkPad logo).

- If the system status indicator (illuminated ThinkPad logo) blinks slowly, your computer is in sleep mode. Connect the ac power adapter to the computer; then press Fn.
- If the system status indicator (illuminated ThinkPad logo) is off, your computer is in power-off state or in hibernation mode. Connect the ac power adapter to the computer; then press the power button to resume operation.

If the system still does not return from sleep mode, your system might stop responding and you might not be able to turn off the computer. In this case, you need to reset the computer. If you have not saved your data, it might be lost. To reset the computer, press and hold the power button for four seconds or more. If the system is still not reset, remove the ac power adapter and reset the system by inserting a straightened paper clip into the emergency reset hole. To locate the emergency reset hole, refer to “Bottom view” on page 6.

- **Problem:** Your computer does not enter sleep or hibernation mode.

**Solution:** Check whether any option has been selected to disable your computer from entering sleep or hibernation mode.

If your computer tries to enter sleep mode but the request is rejected, the device attached to the USB connector might have been disabled. If this occurs, do a hot-unplug-and-plug operation for the USB device.

- **Problem:** The batteries discharge slightly while the computer is in hibernation mode.

**Solution:** If the wakeup function is enabled, the computer consumes small amount of power. This is not a defect. For more information, see “Power-saving modes” on page 29.

## Problems with drives and other storage devices

This section includes hard disk drive problems and solid-state drive problems.

### Hard disk drive problems

- **Problem:** The hard disk drive makes a rattling noise intermittently.

**Solution:** The rattling noise might be heard:

- When the hard disk drive begins or finishes getting access to data.
- When you carry the hard disk drive.
- When you carry your computer.

This is a normal characteristic of a hard disk drive and is not a defect.

- **Problem:** The hard disk drive does not work.

**Solution:** On the **Startup** menu of ThinkPad Setup, make sure that the hard disk drive is on the **Boot priority order** list. If it is on the **Excluded from boot order** list, it is disabled. Select the entry for it on the list and press Shift+1 to move it back to the **Boot priority order** list.

- **Problem:** After setting a hard disk password on the hard disk drive of the computer, you moved the drive to another computer. Now you cannot unlock the hard disk password.

**Solution:** Your computer supports an enhanced password algorithm. Computers older than yours might not support such a security function.

### A solid-state drive problem

**Problem:** When you compress files or folders by use of the data compression function in Windows, and then decompress them, the process of writing to or reading from the files or folders is slow.

**Solution:** Apply the disk defragmentation tool in Windows for faster access to the data.



## A software problem

**Problem:** An application does not run correctly.

**Solution:** Make sure that the problem is not being caused by the application.

Check that your computer has the minimum required memory to run the application. Refer to the manuals supplied with the application.

Check the following:

- The application is designed to operate with your operating system.
- Other applications run correctly on your computer.
- The necessary device drivers are installed.
- The application works when it is run on some other computer.

If an error message is displayed while you are using the application program, refer to the manuals supplied with the application.

If the application still does not run correctly, contact your place of purchase or a service representative for help.

## Problems with ports and connectors

The following are the most common problems with ports and connectors.

### A USB problem

**Problem:** A device connected to the USB connector does not work.

**Solution:** Open the Device Manager window. Make sure that the USB device setup is correct, and that the assignment of computer resource and the installation of the device driver are correct. To open the Device Manager window, go to Control Panel and click **Hardware and Sound → Device Manager**. If you are prompted for an administrator password or confirmation, type the password or provide confirmation.

Refer to “Diagnosing problems” on page 123 and run a diagnostic test of the USB connector.

### A docking station problem

**Problem:** The computer does not start when you try to turn it on, and does not respond when you try to resume operation.

**Solution:** Make sure that:

- The ac power adapter is connected to the docking station.
- The computer is securely attached to the docking station.



---

## Chapter 11. Getting support

This chapter provides information about getting help and support from Lenovo.

- “Before you contact Lenovo” on page 139
- “Getting help and service” on page 139
- “Purchasing additional services” on page 141

---

### Before you contact Lenovo

Often, you can solve your computer problems by referring to the information in the explanations of error codes, running diagnostic programs, or by consulting the Lenovo Web site.

#### Registering your computer

Register your computer with Lenovo. For more information, see “Registering your computer” on page 19.

#### Downloading system updates

Downloading updated software might resolve problems you experience with your computer.

To download updated software, go to the following Web site and follow the instructions on the screen:  
<http://www.lenovo.com/support>

#### Recording information

Before you talk to a Lenovo representative, record the following important information about your computer.

#### Recording problem symptoms and details

Collect the answers to the questions below before you call for help. Then, you will be able to get help as quickly as possible.

- What is the problem? Is it continuous or intermittent?
- Is there an error message? What is the error code, if any?
- What operating system are you using? Which version?
- Which software programs were running at the time of the problem?
- Can the problem be reproduced? If so, how?

#### Recording system information

The serial number label is on the bottom of your computer. Record the machine type and the serial number.

- What is the name of your Lenovo product?
- What is the machine type?
- What is the serial number?

---

### Getting help and service

If you need help, service, technical assistance, or just want more information about Lenovo products, you will find a wide variety of sources available from Lenovo to assist you. This section contains information about where to go for additional information about Lenovo and our products, what to do if you experience a problem with your computer, and whom to call for service should it be necessary.

Information about your computer and preinstalled software, if any, is available in the documentation that comes with your computer. That documentation includes printed books, online books, readme files, and help files. In addition, information about Lenovo products is available on the World Wide Web.

Microsoft Service Packs are the latest software source for Windows product updates. They are available through Web download (connection charges might apply) or through disc. For more specific information and links, go to <http://www.microsoft.com>. Lenovo offers technical assistance with installation of, or questions related to, Service Packs for your Lenovo-preloaded Microsoft Windows product. For information, contact the Customer Support Center.

## Using diagnostic programs

Many computer problems can be solved without outside assistance. If you experience a problem with your computer, the first place to start is the troubleshooting information of your computer documentation. If you suspect a software problem, see the documentation, including readme files and help information systems, that comes with the operating system or application program.

ThinkPad notebook computers come with a set of diagnostic programs that you can use to help you identify hardware problems. See “Diagnosing problems” on page 123 for instructions on using the diagnostic programs.

The troubleshooting information or the diagnostic programs might tell you that you need additional or updated device drivers or other software. You can get the latest technical information and download device drivers and updates from the Lenovo Web site at <http://www.lenovo.com/support>.

## Lenovo Support Web site

Technical support information is available on the Lenovo Support Web site at: <http://www.lenovo.com/support>

This Web site is updated with the latest support information such as the following:

- Drivers and software
- Diagnostic solutions
- Product and service warranty
- Product and parts details
- User guides and manuals
- Knowledge base and frequently asked questions

## Calling Lenovo

If you have tried to correct the problem yourself and still need help, during the warranty period, you can get help and information by telephone through the Customer Support Center. The following services are available during the warranty period:

- Problem determination - Trained personnel are available to assist you with determining if you have a hardware problem and deciding what action is necessary to fix the problem.
- Lenovo hardware repair - If the problem is determined to be caused by Lenovo hardware under warranty, trained service personnel are available to provide the applicable level of service.
- Engineering change management - Occasionally, there might be changes that are required after a product has been sold. Lenovo or your reseller, if authorized by Lenovo, will make selected Engineering Changes (ECs) that apply to your hardware available.

The following items are not covered:

- Replacement or use of parts not manufactured for or by Lenovo or nonwarranted parts
- Identification of software problem sources
- Configuration of the UEFI BIOS as part of an installation or upgrade
- Changes, modifications, or upgrades to device drivers
- Installation and maintenance of network operating systems (NOS)
- Installation and maintenance of application programs

For the terms and conditions of the Lenovo Limited Warranty that applies to your Lenovo hardware product, see “Warranty information” in the *Safety, Warranty, and Setup Guide* that comes with your computer.

If possible, be near your computer when you make your call in case the technical assistance representative needs to help you resolve a computer problem. Ensure that you have downloaded the most current drivers and system updates, run diagnostics, and recorded information before you call. When calling for technical assistance, have the following information available:

- Machine type and model
- Serial numbers of your computer, monitor, and other components, or your proof of purchase
- Description of the problem
- Exact wording of any error messages
- Hardware and software configuration information for your system

### Telephone numbers

For a list of the Lenovo Support phone numbers for your country or region, go to <http://www.lenovo.com/support/phone> or refer to the *Safety, Warranty, and Setup Guide* that comes with your computer.

**Note:** Phone numbers are subject to change without notice. The latest phone numbers are available at <http://www.lenovo.com/support/phone>. If the number for your country or region is not provided, contact your Lenovo reseller or Lenovo marketing representative.

---

## Purchasing additional services

During and after the warranty period, you can purchase additional services, such as support for Lenovo and non-Lenovo hardware, operating systems, and application programs; network setup and configuration services; upgraded or extended hardware repair services; and custom installations services. Service availability and service name might vary by country.

For more information about these services, go to:  
<http://www.lenovo.com/accessories/services/index.html>



---

## Appendix A. Regulatory Information

---

### Wireless related information

#### Wireless interoperability

The M.2 wireless LAN card is designed to be interoperable with any wireless LAN product that is based on Direct Sequence Spread Spectrum (DSSS), Complementary Code Keying (CCK), and/or Orthogonal Frequency Division Multiplexing (OFDM) radio technology, and is compliant to:

- The 802.11b/g Standard, 802.11a/b/g or 802.11n draft 2.0 on Wireless LANs, as defined and approved by the Institute of Electrical and Electronics Engineers.
- The Wireless Fidelity (WiFi) certification as defined by the Wi-Fi Alliance.

Your Bluetooth card is compliant with Bluetooth Specification 4.0 as defined by the Bluetooth Special Interest Group SIG. It supports the following profiles:

- Advanced Audio Distribution Profile (A2DP)
- Audio/Video Control Transport Protocol (AVCTP)
- Audio/Video Distribution Transport Protocol (AVDTP)
- A/V Remote Control Profile (AVRCP)
- Basic Imaging Profile (BIP)
- Basic Printing Profile (BPP)
- Dial-Up Networking Profile (DUN)
- File Transfer Profile (FTP)
- Generic Access Profile (GAP)
- Generic A/V Distribution Profile (GAVDP)
- Hardcopy Cable Replacement Profile (HCRP)
- Headset Profile (HSP)
- Hands-Free Profile (HFP)
- Human Interface Device Profile (HID)
- Message Access Profile (MAP)
- Object Exchange Protocol (OBEX)
- Object Push Profile (OPP)
- Personal Area Networking Profile (PAN)
- Phone Book Access Profile (PBAP)
- Service Discovery Protocol (SDP)
- Synchronization Profile (SYNC)
- Video Distribution Profile (VDP)
- Generic Attribute Profile (GATT)
- Proximity Profile
- Find Me Profile
- Immediate Alert Profile

- Battery Status Profile

### Usage environment and your health

Integrated wireless cards emit radio frequency electromagnetic energy like other radio devices. However, the level of energy emitted is far much less than the electromagnetic energy emitted by wireless devices like for example mobile phones.

Due to the fact that integrated wireless cards operate within the guidelines found in radio frequency safety standards and recommendations, Lenovo believes they are safe for use by consumers. These standards and recommendations reflect the consensus of the scientific community and result from deliberations of panels and committees of scientists who continually review and interpret the extensive research literature.

In some situation or environment, the use of integrated wireless cards might be restricted by the proprietor of the building or responsible representatives of the organization. These situations and areas might for example include:

- Using the integrated wireless cards on board of airplanes, in hospitals or near petrol stations, blasting areas (with electro-explosive devices), medical implants or body-worn electronic medical devices, such as pace makers.
- In any other environment where the risk of interference to other devices or services is perceived or identified as harmful.

If you are uncertain of the policy that applies to the use of wireless devices in a specific organization (such as airport or hospital), you are encouraged to ask for authorization to use integrated wireless cards prior to turning on the computer.

### Locations of the UltraConnect™ wireless antennas

ThinkPad models feature a diversified antenna system built into the display for optimal reception, which enables wireless communication wherever you are.



**1** Wireless LAN antenna (auxiliary) and Wireless WAN antenna (auxiliary)

**2** Wireless WAN antenna (main) and Wireless LAN antenna (main)



## Locating wireless regulatory notices

For more information about the wireless regulatory notices, refer to the *Regulatory Notice* shipped with the computer.

If the computer is shipped without the *Regulatory Notice*, you can find it on the Web site at: <http://www.lenovo.com/ThinkPadUserGuides>

---

## Export classification notice

This product is subject to the United States Export Administration Regulations (EAR) and has an Export Classification Control Number (ECCN) of 4A994.b. It can be re-exported except to any of the embargoed countries in the EAR E1 country list.

---

## Electronic emission notices

The following information refers to the ThinkPad T440s computer, machine types 20AQ and 20AR.

## Federal Communications Commission Declaration of Conformity

This equipment has been tested and found to comply with the limits for a Class B digital device, pursuant to Part 15 of the FCC Rules. These limits are designed to provide reasonable protection against harmful interference in a residential installation. This equipment generates, uses, and can radiate radio frequency energy and, if not installed and used in accordance with the instructions, may cause harmful interference to radio communications. However, there is no guarantee that interference will not occur in a particular installation. If this equipment does cause harmful interference to radio or television reception, which can be determined by turning the equipment off and on, the user is encouraged to try to correct the interference by one or more of the following measures:

- Reorient or relocate the receiving antenna.
- Increase the separation between the equipment and receiver.
- Connect the equipment into an outlet on a circuit different from that to which the receiver is connected.
- Consult an authorized dealer or service representative for help.

Lenovo is not responsible for any radio or television interference caused by using other than specified or recommended cables and connectors or by unauthorized changes or modifications to this equipment. Unauthorized changes or modifications could void the user's authority to operate the equipment.

This device complies with Part 15 of the FCC Rules. Operation is subject to the following two conditions: (1) this device may not cause harmful interference, and (2) this device must accept any interference received, including interference that may cause undesired operation.

Responsible Party:  
Lenovo (United States) Incorporated  
1009 Think Place - Building One  
Morrisville, NC 27560  
Phone Number: 919-294-5900



## Industry Canada Class B emission compliance statement

This Class B digital apparatus complies with Canadian ICES-003.

Cet appareil numérique de la classe B est conforme à la norme NMB-003 du Canada.

## European Union - Compliance to the Electromagnetic Compatibility Directive

This product is in conformity with the protection requirements of EU Council Directive 2004/108/EC on the approximation of the laws of the Member States relating to electromagnetic compatibility. Lenovo cannot accept responsibility for any failure to satisfy the protection requirements resulting from a non-recommended modification of the product, including the installation of option cards from other manufacturers.

This product has been tested and found to comply with the limits for Class B Information Technology Equipment according to European Standard EN 55022. The limits for Class B equipment were derived for typical residential environments to provide reasonable protection against interference with licensed communication devices.

EU contact: Lenovo, Einsteinova 21, 851 01 Bratislava, Slovakia



### German Class B compliance statement

#### Deutschsprachiger EU Hinweis:

##### **Hinweis für Geräte der Klasse B EU-Richtlinie zur Elektromagnetischen Verträglichkeit**

Dieses Produkt entspricht den Schutzanforderungen der EU-Richtlinie 2004/108/EG (früher 89/336/EWG) zur Angleichung der Rechtsvorschriften über die elektromagnetische Verträglichkeit in den EU-Mitgliedsstaaten und hält die Grenzwerte der EN 55022 Klasse B ein.

Um dieses sicherzustellen, sind die Geräte wie in den Handbüchern beschrieben zu installieren und zu betreiben. Des Weiteren dürfen auch nur von der Lenovo empfohlene Kabel angeschlossen werden. Lenovo übernimmt keine Verantwortung für die Einhaltung der Schutzanforderungen, wenn das Produkt ohne Zustimmung der Lenovo verändert bzw. wenn Erweiterungskomponenten von Fremdherstellern ohne Empfehlung der Lenovo gesteckt/eingebaut werden.

#### **Deutschland:**

##### **Einhaltung des Gesetzes über die elektromagnetische Verträglichkeit von Betriebsmitteln**

Dieses Produkt entspricht dem „Gesetz über die elektromagnetische Verträglichkeit von Betriebsmitteln“ EMVG (früher „Gesetz über die elektromagnetische Verträglichkeit von Geräten“). Dies ist die Umsetzung der EU-Richtlinie 2004/108/EG (früher 89/336/EWG) in der Bundesrepublik Deutschland.

##### **Zulassungsbescheinigung laut dem Deutschen Gesetz über die elektromagnetische Verträglichkeit von Betriebsmitteln, EMVG vom 20. Juli 2007 (früher Gesetz über die elektromagnetische Verträglichkeit von Geräten), bzw. der EMV EG Richtlinie 2004/108/EC (früher 89/336/EWG), für Geräte der Klasse B.**

Dieses Gerät ist berechtigt, in Übereinstimmung mit dem Deutschen EMVG das EG-Konformitätszeichen - CE - zu führen. Verantwortlich für die Konformitätserklärung nach Paragraf 5 des EMVG ist die Lenovo (Deutschland) GmbH, Gropiusplatz 10, D-70563 Stuttgart.

Informationen in Hinsicht EMVG Paragraf 4 Abs. (1) 4:

**Das Gerät erfüllt die Schutzanforderungen nach EN 55024 und EN 55022 Klasse B.**

## Korea Class B compliance statement

B급 기기 (가정용 방송통신기자재)
이 기기는 가정용 (B급) 전자파적합기기로서 주로 가정에서 사용하는 것을 목적으로 하며, 모든 지역에서 사용할 수 있습니다

## Japan VCCI Class B compliance statement

この装置は、クラスB情報技術装置です。この装置は、家庭環境で使用することを目的としていますが、この装置がラジオやテレビジョン受信機に近接して使用されると、受信障害を引き起こすことがあります。  
取扱説明書に従って正しい取り扱いをして下さい。 VCCI-B

## Japan compliance statement for products which connect to the power mains with rated current less than or equal to 20 A per phase

日本の定格電流が 20A/相 以下の機器に対する高調波電流規制  
高調波電流規格 JIS C 61000-3-2 適合品

## Lenovo product service information for Taiwan

台灣 Lenovo 產品服務資訊如下：  
荷蘭商聯想股份有限公司台灣分公司  
台北市信義區信義路五段七號十九樓之一  
服務電話：0800-000-702

---

## Eurasian compliance mark





---

## Appendix B. WEEE and recycling statements

Lenovo encourages owners of information technology (IT) equipment to responsibly recycle their equipment when it is no longer needed. Lenovo offers a variety of programs and services to assist equipment owners in recycling their IT products. For information on recycling Lenovo products, go to:  
<http://www.lenovo.com/recycling>

---

### Important WEEE information

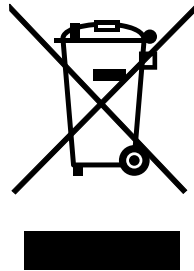

The WEEE marking on Lenovo products applies to countries with WEEE and e-waste regulations (for example, European Directive 2002/96/EC, India E-Waste Management & Handling Rules, 2011). Appliances are labeled in accordance with local regulations concerning waste electrical and electronic equipment (WEEE). These regulations determine the framework for the return and recycling of used appliances as applicable within each geography. This label is applied to various products to indicate that the product is not to be thrown away, but rather put in the established collection systems for reclaiming these end of life products.

Users of electrical and electronic equipment (EEE) with the WEEE marking must not dispose of end of life EEE as unsorted municipal waste, but use the collection framework available to them for the return, recycle, and recovery of WEEE and to minimize any potential effects of EEE on the environment and human health due to the presence of hazardous substances. For additional WEEE information go to:  
<http://www.lenovo.com/recycling>

---

### Recycling information for Japan

#### Collecting and recycling a disused Lenovo computer or monitor

If you are a company employee and need to dispose of a Lenovo computer or monitor that is the property of the company, you must do so in accordance with the Law for Promotion of Effective Utilization of Resources. Computers and monitors are categorized as industrial waste and should be properly disposed of by an industrial waste disposal contractor certified by a local government. In accordance with the Law for Promotion of Effective Utilization of Resources, Lenovo Japan provides, through its PC Collecting and Recycling Services, for the collecting, reuse, and recycling of disused computers and monitors. For details, visit the Lenovo Web site at <http://www.lenovo.com/recycling/japan>.

Pursuant to the Law for Promotion of Effective Utilization of Resources, the collecting and recycling of home-used computers and monitors by the manufacturer was begun on October 1, 2003. This service is provided free of charge for home-used computers sold after October 1, 2003. For details, go to <http://www.lenovo.com/recycling/japan>.

## Disposing of Lenovo computer components

Some Lenovo computer products sold in Japan may have components that contain heavy metals or other environmental sensitive substances. To properly dispose of disused components, such as a printed circuit board or drive, use the methods described above for collecting and recycling a disused computer or monitor.

## Disposing of disused lithium batteries from Lenovo computers

A button-shaped lithium battery is installed inside your Lenovo computer to provide power to the computer clock while the computer is off or disconnected from the main power source. If you need to replace it with a new one, contact your place of purchase or contact Lenovo for service. If you need to dispose of a disused lithium battery, insulate it with vinyl tape, contact your place of purchase or an industrial-waste-disposal operator, and follow their instructions.

Disposal of a lithium battery must comply with local ordinances and regulations.

## Disposing of a disused battery pack from Lenovo notebook computers

Your Lenovo notebook computer has a lithium ion battery pack or a nickel metal hydride battery pack. If you are a company employee who uses a Lenovo notebook computer and need to dispose of a battery pack, contact the proper person in Lenovo sales, service, or marketing, and follow that person's instructions. You also can refer to the instructions at <http://www.lenovo.com/jp/ja/environment/recycle/battery/>.

If you use a Lenovo notebook computer at home and need to dispose of a battery pack, you must comply with local ordinances and regulations. You also can refer to the instructions at <http://www.lenovo.com/jp/ja/environment/recycle/battery/>.

---

## Battery recycling information for Brazil

### Declarações de Reciclagem no Brasil

#### Descarte de um Produto Lenovo Fora de Uso

Equipamentos elétricos e eletrônicos não devem ser descartados em lixo comum, mas enviados à pontos de coleta, autorizados pelo fabricante do produto para que sejam encaminhados e processados por empresas especializadas no manuseio de resíduos industriais, devidamente certificadas pelos órgãos ambientais, de acordo com a legislação local.

A Lenovo possui um canal específico para auxiliá-lo no descarte desses produtos. Caso você possua um produto Lenovo em situação de descarte, ligue para o nosso SAC ou encaminhe um e-mail para: [reciclar@lenovo.com](mailto:reciclar@lenovo.com), informando o modelo, número de série e cidade, a fim de enviarmos as instruções para o correto descarte do seu produto Lenovo.

---

## Battery recycling information for Taiwan



廢電池請回收

---

## Battery recycling information for the European Union

EU

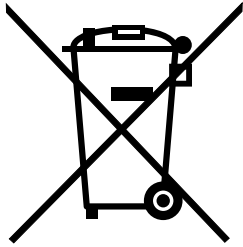

**Notice:** This mark applies only to countries within the European Union (EU).

Batteries or packaging for batteries are labeled in accordance with European Directive 2006/66/EC concerning batteries and accumulators and waste batteries and accumulators. The Directive determines the framework for the return and recycling of used batteries and accumulators as applicable throughout the European Union. This label is applied to various batteries to indicate that the battery is not to be thrown away, but rather reclaimed upon end of life per this Directive.

In accordance with the European Directive 2006/66/EC, batteries and accumulators are labeled to indicate that they are to be collected separately and recycled at end of life. The label on the battery may also include a chemical symbol for the metal concerned in the battery (Pb for lead, Hg for mercury, and Cd for cadmium). Users of batteries and accumulators must not dispose of batteries and accumulators as unsorted municipal waste, but use the collection framework available to customers for the return, recycling, and treatment of batteries and accumulators. Customer participation is important to minimize any potential effects of batteries and accumulators on the environment and human health due to the potential presence of hazardous substances. For proper collection and treatment, go to:  
<http://www.lenovo.com/lenovo/environment>

---

## Battery recycling information for the United States and Canada



US & Canada Only





## Appendix C. Restriction of Hazardous Substances Directive (RoHS)

### European Union RoHS

Lenovo products sold in the European Union, on or after 3 January 2013 meet the requirements of Directive 2011/65/EU on the restriction of the use of certain hazardous substances in electrical and electronic equipment (“RoHS recast” or “RoHS 2”).

For more information about Lenovo progress on RoHS, go to:  
[http://www.lenovo.com/social\\_responsibility/us/en/RoHS\\_Communication.pdf](http://www.lenovo.com/social_responsibility/us/en/RoHS_Communication.pdf)

### China RoHS

产品中有毒有害物质或元素的名称及含量

部件名称	有毒有害物质或元素					
	铅(Pb)	汞(Hg)	镉(Cd)	六价铬 (Cr(VI))	多溴连苯 (PBB)	多溴二苯醚 (PBDE)
印刷电路板组件*	X	O	O	O	O	O
硬盘	X	O	O	O	O	O
光驱	X	O	O	O	O	O
内存	X	O	O	O	O	O
电脑I/O 附件	X	O	O	O	O	O
电源	X	O	O	O	O	O
键盘	X	O	O	O	O	O
鼠标	X	O	O	O	O	O
机箱/ 附件	X	O	O	O	O	O

○:表示该有毒有害物质在该部件所有均质材料中的含量均在SJ/T11363-2006标准规定的限量要求以下  
 ×:表示该有毒有害物质至少在该部件的某一均质材料中的含量超出SJ/T11363-2006标准规定的限量要求  
 表中标有“×”的所有部件都符合欧盟RoHS 法规。

印刷电路板组件\*: 包括印刷电路板及其零部件、电容和连接器  
 根据型号的不同, 可能不会含有以上的所有部件, 请以实际购买机型为准



在中华人民共和国境内销售的电子信息产品必须标识此标志, 标志内的数字代表在正常使用状态下的产品的环保使用期限

### India RoHS

RoHS compliant as per E-Waste (Management & Handling) Rules, 2011.

### Turkish RoHS

The Lenovo product meets the requirements of the Republic of Turkey Directive on the Restriction of the Use of Certain Hazardous Substances in Electrical and Electronic Equipment (EEE).

### **Türkiye EEE Yönetmeliğine Uygunluk Beyanı**

Bu Lenovo ürünü, T.C. Çevre ve Orman Bakanlığı'nın "Elektrik ve Elektronik Eşyalarda Bazı Zararlı Maddelerin Kullanımının Sınırlandırılmasına Dair Yönetmelik (EEE)" direktiflerine uygundur.

EEE Yönetmeliğine Uygundur.

---

### **Ukraine RoHS**

Цим підтверджуємо, що продукція Леново відповідає вимогам нормативних актів України, які обмежують вміст небезпечних речовин

---

## Appendix D. ENERGY STAR model information



ENERGY STAR® is a joint program of the U.S. Environmental Protection Agency and the U.S. Department of Energy aimed at saving money and protecting the environment through energy efficient products and practices.

Lenovo is proud to offer our customers products with the ENERGY STAR qualified designation. Lenovo computers of the following machine type, if the ENERGY STAR mark is affixed, has been designed and tested to conform to the ENERGY STAR program requirements for computers.

20AQ and 20AR

By using ENERGY STAR qualified products and taking advantage of the power-management features of the computer, you can help reduce the consumption of electricity. Reduced electrical consumption can contribute to potential financial savings, a cleaner environment, and the reduction of greenhouse gas emissions.

For more information about ENERGY STAR, go to:  
<http://www.energystar.gov>

Lenovo encourages you to make efficient use of energy an integral part of your day-to-day operations. To help in this endeavor, Lenovo has preset the following power-management features to take effect when the computer has been inactive for a specified length of time:

**Power plan: Energy Saver (settings when plugged into ac power)**

- Turn off the display: After 10 minutes
- Put the computer into sleep: After 20 minutes
- Advanced power settings:
  - Turn off hard disks: After 15 minutes
  - Hibernate: Never

To awaken the computer from sleep mode, press the Fn key on your keyboard. For more information about these settings, see the Windows Help and Support information on the computer.

The Wake on LAN function is enabled when your Lenovo computer is shipped from the factory, and the setting remains valid even when the computer is in sleep mode. If you do not need to have Wake on LAN enabled while the computer is in sleep mode, you can reduce the power consumption and prolong the time in sleep mode, by disabling the setting of Wake on LAN for sleep mode.

To disable the setting of Wake on LAN for sleep mode, do the following:

1. Click **Start** → **Control panel**.
2. Click **Hardware and Sound** → **Device Manager**.

3. In the Device Manager window, expand **Network adapters**.
4. Right-click your network adapter device, and click **Properties**.
5. Click the **Power Management** tab.
6. Clear the **Allow this device to wake the computer** check box.
7. Click **OK**.

---

## Appendix E. Notices

Lenovo may not offer the products, services, or features discussed in this document in all countries. Consult your local Lenovo representative for information on the products and services currently available in your area. Any reference to a Lenovo product, program, or service is not intended to state or imply that only that Lenovo product, program, or service may be used. Any functionally equivalent product, program, or service that does not infringe any Lenovo intellectual property right may be used instead. However, it is the user's responsibility to evaluate and verify the operation of any other product, program, or service.

Lenovo may have patents or pending patent applications covering subject matter described in this document. The furnishing of this document does not give you any license to these patents. You can send license inquiries, in writing, to:

*Lenovo (United States), Inc.  
1009 Think Place - Building One  
Morrisville, NC 27560  
U.S.A.  
Attention: Lenovo Director of Licensing*

LENOVO PROVIDES THIS PUBLICATION "AS IS" WITHOUT WARRANTY OF ANY KIND, EITHER EXPRESS OR IMPLIED, INCLUDING, BUT NOT LIMITED TO, THE IMPLIED WARRANTIES OF NON-INFRINGEMENT, MERCHANTABILITY OR FITNESS FOR A PARTICULAR PURPOSE. Some jurisdictions do not allow disclaimer of express or implied warranties in certain transactions, therefore, this statement may not apply to you.

This information could include technical inaccuracies or typographical errors. Changes are periodically made to the information herein; these changes will be incorporated in new editions of the publication. Lenovo may make improvements and/or changes in the product(s) and/or the program(s) described in this publication at any time without notice.

The products described in this document are not intended for use in implantation or other life support applications where malfunction may result in injury or death to persons. The information contained in this document does not affect or change Lenovo product specifications or warranties. Nothing in this document shall operate as an express or implied license or indemnity under the intellectual property rights of Lenovo or third parties. All information contained in this document was obtained in specific environments and is presented as an illustration. The result obtained in other operating environments may vary.

Lenovo may use or distribute any of the information you supply in any way it believes appropriate without incurring any obligation to you.

Any references in this publication to non-Lenovo Web sites are provided for convenience only and do not in any manner serve as an endorsement of those Web sites. The materials at those Web sites are not part of the materials for this Lenovo product, and use of those Web sites is at your own risk.

Any performance data contained herein was determined in a controlled environment. Therefore, the result obtained in other operating environments may vary significantly. Some measurements may have been made on development-level systems and there is no guarantee that these measurements will be the same on generally available systems. Furthermore, some measurements may have been estimated through extrapolation. Actual results may vary. Users of this document should verify the applicable data for their specific environment.

---

## Trademarks

The following terms are trademarks of Lenovo in the United States, other countries, or both:

- Lenovo
- Access Connections
- Active Protection System
- Rescue and Recovery
- Secure Data Disposal
- ThinkPad
- ThinkVantage
- TrackPoint
- UltraConnect

Intel and Intel SpeedStep are trademarks of Intel Corporation in the U.S. and/or other countries.

Microsoft, Windows, and BitLocker are trademarks of the Microsoft group of companies.

Other company, product, and service names may be trademarks or service marks of others.



**ThinkPad®**



