

L5006tm and L5009tm Touchscreen Monitors User Guide



© 2006–2009 Hewlett-Packard
Development Company, L.P.

Microsoft, Windows, and Windows Vista are either trademarks or registered trademarks of Microsoft Corporation in the United States and/or other countries.

Elo TouchSystems, IntelliTouch and TouchTools are trademarks of Tyco Electronics Corporation.

The only warranties for HP products and services are set forth in the express warranty statements accompanying such products and services. Nothing herein should be construed as constituting an additional warranty. HP shall not be liable for technical or editorial errors or omissions contained herein.

This document contains proprietary information that is protected by copyright. No part of this document may be photocopied, reproduced, or translated to another language without the prior written consent of Hewlett-Packard Company.

Third Edition (October 2009)

Document Part Number: 419998-003

About This Guide

This guide provides information on setting up the monitor, installing drivers, using the on-screen display menu, troubleshooting and technical specifications.

- △ **WARNING!** Text set off in this manner indicates that failure to follow directions could result in bodily harm or loss of life.
- △ **CAUTION:** Text set off in this manner indicates that failure to follow directions could result in damage to equipment or loss of information.
- 📝 **NOTE:** Text set off in this manner provides important supplemental information.

Table of contents

1 Product Features

HP L5006tm Touchscreen	1
HP Compaq L5009tm Touchscreen	2

2 Safety and Maintenance Guidelines

Important Safety Information	3
Maintenance Guidelines	4
Cleaning the Monitor	4
Shipping the Monitor	4

3 Setting Up the Monitor

Identifying Rear Connectors	5
Connecting the Cables	6
Installing the Serial or USB Touch Drivers	7
Downloading Drivers from the Web	7
Installing Drivers from the CD	7
Removing the Monitor Stand	8
Mounting the Monitor to a Desktop	8
Tilting the Monitor	9
Locating the Rating Labels	9

4 Operating the Monitor

Installing the Monitor Driver	10
The Information File	10
The Image Color Matching File	10
Installing the .INF and .ICM Files	11
Installing from the CD	11
Downloading from the Worldwide Web	11
Adjusting the Monitor	11
Front Panel Controls	12
Using the On-Screen Display	13
OSD Menu Table	13
Identifying Monitor Conditions	14
Power Management System	14

OSD and Power Lock/Unlock	15
---------------------------------	----

Appendix A Troubleshooting

Solving Common Problems	16
Touchscreen Tips	17
Online Technical Support	19
Preparing to Call Technical Support	19

Appendix B Technical Specifications

HP L5006tm Touchscreen	20
HP Compaq L5009tm Touchscreen	21
IntelliTouch Surface Acoustic Wave Technology	23
Acoustic Pulse Recognition Technology	24
Recognizing Preset Display Resolutions	25
HP L5006tm and L5009tm	25
Entering User Modes	25
Energy Saver Feature	26

Appendix C Agency Regulatory Notices

Federal Communications Commission Notice	27
Modifications	27
Cables	27
Declaration of Conformity for Products Marked with the FCC Logo (United States Only)	27
Canadian Notice	28
Avis Canadien	28
European Union Regulatory Notice	28
German Ergonomics Notice	29
Japanese Notice	29
Korean Notice	29
Power Cord Set Requirements	29
Japanese Power Cord Requirements	29
Product Environmental Notices	30
Materials Disposal	30
Disposal of Waste Equipment by Users in Private Household in the European Union	30
HP Recycling Program	30
Chemical Substances	30
Restriction of Hazardous Substances (RoHS)	30
Turkey EEE Regulation	31

Appendix D Native Resolution

1 Product Features

The LCD (liquid crystal display) monitors have an active matrix, thin-film transistor (TFT) panel. The monitors feature:

HP L5006tm Touchscreen

- Maximum resolution of XGA 1024 x 768. Compatible with VGA, SVGA and XGA (non-interlace) color video cards
- Integrated IntelliTouch touchscreen technology from the Elo TouchSystems business of Tyco Electronics Corporation
- Sealed touchscreen responds to touch with finger, gloved hand, or soft stylus
- Tilt capability
- USB and Serial touch cables provided
- Power and video cables provided
- Video input supports analog signal inputs
- Plug and play capability if supported by the system
- On-Screen Display (OSD) adjustments in several languages for easy setup and screen optimization
- Software and documentation CD that includes the Elo TouchSystems IntelliTouch software, HP monitor driver software and product documentation
- Detachable stand for wall mounting application
- Compliant with Swedish MPR II 1990 regulated specifications

HP Compaq L5009tm Touchscreen

- Maximum resolution of XGA 1024 x 768. Compatible with VGA, SVGA and XGA (non-interlace) color video cards
- Integrated Acoustic Pulse Recognition (APR) technology from the Elo TouchSystems business of Tyco Electronics Corporation
- Sealed touchscreen responds to touch with finger, finger nail, gloved hand, pen or stylus activation
- Tilt capability
- Power, video and APR USB cables provided
- Video input supports analog signal inputs
- Plug and play capability if supported by the system
- On-Screen Display (OSD) adjustments in several languages for easy setup and screen optimization
- Software and documentation CD that includes the Elo TouchSystems APR USB touch driver, HP monitor driver software and product documentation
- Detachable stand for wall mounting application
- Compliant with Swedish MPR II 1990 regulated specifications
- TCO Displays Requirement

2 Safety and Maintenance Guidelines

Important Safety Information

A power cord is included with the monitor. If another cord is used, use only a power source and connection appropriate for this monitor. For information on the correct power cord set to use with the monitor, refer to the [Power Cord Set Requirements on page 29](#) in Appendix C.

⚠ **WARNING!** To reduce the risk of electric shock or damage to the equipment:

- Do not disable the power cord grounding feature. The grounding plug is an important safety feature.
- Plug the power cord in a grounded (earthed) outlet that is easily accessible at all times.
- Disconnect power from the product by unplugging the power cord from the electrical outlet.

For your safety, do not place anything on power cords or cables. Arrange them so that no one may accidentally step on or trip over them. Do not pull on a cord or cable. When unplugging from the electrical outlet, grasp the cord by the plug.

To reduce the risk of serious injury, read the *Safety and Comfort Guide*. It describes proper workstation, setup, posture, and health and work habits for computer users, and provides important electrical and mechanical safety information. This guide is located on the Web at <http://www.hp.com/ergo> and/or on the documentation CD, if one is included with the monitor.

⚠ **CAUTION:** For the protection of the monitor, as well as the computer, connect all power cords for the computer and its peripheral devices (such as a monitor, printer, scanner) to some form of surge protection device such as a power strip or Uninterruptible Power Supply (UPS). Not all power strips provide surge protection; the power strips must be specifically labeled as having this ability. Use a power strip whose manufacturer offers a Damage Replacement Policy so you can replace the equipment, if surge protection fails.

Use the appropriate and correctly sized furniture designed to properly support your HP LCD monitor.

⚠ **WARNING!** LCD monitors that are inappropriately situated on dressers, bookcases, shelves, desks, speakers, chests, or carts may fall over and cause personal injury.

Care should be taken to route all cords and cables connected to the LCD monitor so that they can not be pulled, grabbed, or tripped over.

Maintenance Guidelines

To enhance the performance and extend the life of the monitor:

- Do not open the monitor cabinet or attempt to service this product yourself. Adjust only those controls that are covered in the operating instructions. If the monitor is not operating properly or has been dropped or damaged, contact an authorized HP dealer, reseller, or service provider.
- Use only a power source and connection appropriate for this monitor, as indicated on the label/back plate of the monitor.
- Be sure the total ampere rating of the products connected to the outlet does not exceed the current rating of the electrical outlet, and the total ampere rating of the products connected to the cord does not exceed the rating of the cord. Look on the power label to determine the ampere rating (AMPS or A) for each device.
- Install the monitor near an outlet that you can easily reach. Disconnect the monitor by grasping the plug firmly and pulling it from the outlet. Never disconnect the monitor by pulling the cord.
- Turn the monitor off when not in use. You can substantially increase the life expectancy of the monitor by using a screen saver program and turning off the monitor when not in use.
- Slots and openings in the cabinet are provided for ventilation. These openings must not be blocked or covered. Never push objects of any kind into cabinet slots or other openings.
- Do not drop the monitor or place it on an unstable surface.
- Do not allow anything to rest on the power cord. Do not walk on the cord.
- Keep the monitor in a well-ventilated area, away from excessive light, heat or moisture.
- When removing the monitor base, you must lay the monitor face down on a soft area to prevent it from getting scratched, defaced, or broken.

Cleaning the Monitor

1. Turn off the monitor and the computer.
2. Unplug the monitor from the wall outlet.
3. To clean the display unit cabinet, use a cloth lightly dampened with a mild detergent.
4. Clean the touchscreen with window or glass cleaner. Put the cleaner on the cloth and wipe the touchscreen. Never apply the cleaner directly to the touchscreen.

△ **CAUTION:** Do not use alcohol (methyl, ethyl or isopropyl) or any strong dissolvent. Do not use thinner or benzene, abrasive cleaners or compressed air.

Avoid getting liquids inside the touchmonitor. If liquid does get inside, have a qualified service technician check it before you power it on again.

Do not wipe the screen with a cloth or sponge that could scratch the surface.

Shipping the Monitor

Keep the original packing box in a storage area. You may need it later if you move or ship the monitor.

3 Setting Up the Monitor

To set up the monitor, ensure that the power is turned off to the monitor, computer system, and other attached devices, then follow the instructions below.

Identifying Rear Connectors

Figure 3-1 Rear Connectors



Connector	Function
1 AC Power	Connects the AC power cord to the monitor.
2 USB	Connects the touchscreen USB cable to the monitor.
3 Serial	Connects the touchscreen serial cable to the monitor (not available on L5009tm model).
4 VGA	Connects the VGA video cable to the monitor.

NOTE: A +12VDC input jack is available on the connector panel of the L5009tm monitor. This jack accepts an external DC power brick (not included with the monitor).

Connecting the Cables

 **NOTE:** For the L5009tm model, it is best to install the APR driver before connecting the hardware.

1. Place the monitor in a convenient, well-ventilated location near the computer.
2. Connect one end of the power cable (1) to the AC power connector on the back of the monitor, and the other end to an electrical wall outlet.
3. **L5006tm:** Connect one end of the touchscreen serial cable (RS232) or USB cable (2), but not both, to the rear connector of the computer, and the other end to the connector on the monitor. Tighten the two thumb screws on the serial cable to ensure proper grounding. The USB cable does not have thumb screws.

L5009tm: Connect one end of the USB cable to the rear connector of the computer, and the other end to the connector on the monitor.

 **NOTE:** The L5009tm model does not include a serial connector.

4. Connect one end of the video cable (3) to the rear side of the computer and the other to the VGA connector on the monitor.

Figure 3-2 Connecting the Power, USB or Serial and VGA Cables

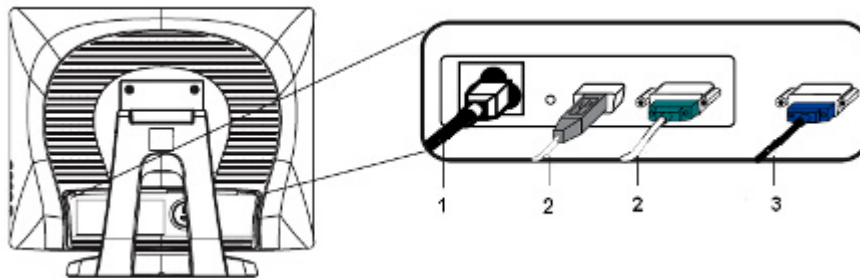

 **NOTE:** Connect either the USB or serial cable to the L5006tm monitor, but not both.

5. Turn on the computer, then press the power button on the side panel to turn the monitor power on.

 **WARNING!** To reduce the risk of electric shock or damage to the equipment:

Do not disable the power cord grounding plug. The grounding plug is an important safety feature.

Plug the power cord into a grounded (earthed) electrical outlet that is easily accessible at all times.

Disconnect power from the equipment by unplugging the power cord from the electrical outlet.

For your safety, do not place anything on power cords or cables. Arrange them so that no one may accidentally step on or trip over them. Do not pull on a cord or cable. When unplugging from the electrical outlet, grasp the cord by the plug.

Installing the Serial or USB Touch Drivers

The Touch driver software can be downloaded from the Web or from the HP software and documentation CD included with the monitor.

Downloading Drivers from the Web

1. Insert the HP software and documentation CD in the computer's CD-ROM drive. The CD will open to a menu screen.
2. From the menu screen, select **Elo TouchSystems TouchTools**.
3. Click **Install Driver for This Computer**.
4. Click **Yes** to download the latest drivers from the Elo Website.
5. Select your operating system version for touch drivers from the Elo Driver and File Downloads page.

 **NOTE:** Depending on whether you connected the USB cable or serial cable, you should install only the USB driver or serial driver.

6. Refer to the online help file with the software for instructions on configuring and adjusting the touchscreen.

Installing Drivers from the CD

1. Insert the HP software and documentation CD in the computer's CD-ROM drive. The CD will open to a menu screen.
2. From the menu screen, select **Elo TouchSystems TouchTools**.
3. Click **Browse CD**.
4. Browse to the latest version of the **EloWinXP Universal** directory containing the driver installation package files.
5. Double-click on **EloSetup.exe** to run the install application for:

- Serial or USB touchscreen driver (L5006tm)

 **NOTE:** Depending on whether you connected the USB or serial cable, you should install only the USB driver or serial driver.

- APR USB touchscreen driver (L5009tm)

 **NOTE:** It is best to install the APR driver before connecting the USB cable to the L5009tm monitor and to the computer. Do not turn off the computer before connecting the USB cable. There is no APR serial (RS232) driver version available for the L5009tm monitor.

6. Click **Next** and follow the on screen instructions to complete the touchscreen setup process.

Removing the Monitor Stand

If you are mounting the panel to a wall or other mounting fixture, you must remove the monitor stand from the panel. The monitor has four mounting holes on the back side of the panel that adheres to the VESA mounting standard.

- △ **CAUTION:** This monitor supports the VESA industry standard 75mm mounting holes. To attach a third party mounting solution to the monitor, four 4mm, 0.7 pitch, and 10mm long screws are required (not provided with the monitor). Longer screws should not be used because they may damage the monitor. It is important to verify that the manufacturer's mounting solution is compliant with the VESA standard and is rated to support the weight of the monitor display panel. For best performance, it is important to use the power and video cable provided with the monitor.

To remove the stand and mount the panel:

1. Turn off the monitor and computer.
2. Disconnect the power, USB or serial and video cables from the monitor and the computer.
3. Lay the monitor face down on a flat surface covered with soft protective cloth.
4. Remove the four screws that secure the stand to the back of the monitor.
5. Follow the instructions from the manufacturer to install the panel to the manufacturer's mounting fixture.
6. Reconnect the power, USB or serial and video cables to the monitor and the computer.
7. Turn on the computer, then turn on the monitor.

Mounting the Monitor to a Desktop

The monitor can be screwed down on a desktop or a tabletop to provide security. Four mounting holes are available on the base of the stand for mounting the monitor.

1. Turn off the monitor and computer.
2. If necessary, disconnect the power, USB or serial and video cables from the monitor and the computer.
3. Position the monitor on the desk or tabletop.
4. Lift the bezel cover from the base of the stand.
5. Install the screws into the holes provided and replace the bezel cover.
6. Reconnect the monitor cables and turn it on.

Tilting the Monitor

For viewing clarity, tilt the monitor forward (up to -5 degrees) or backward (up to 90 degrees).

Figure 3-3 Tilting the Monitor

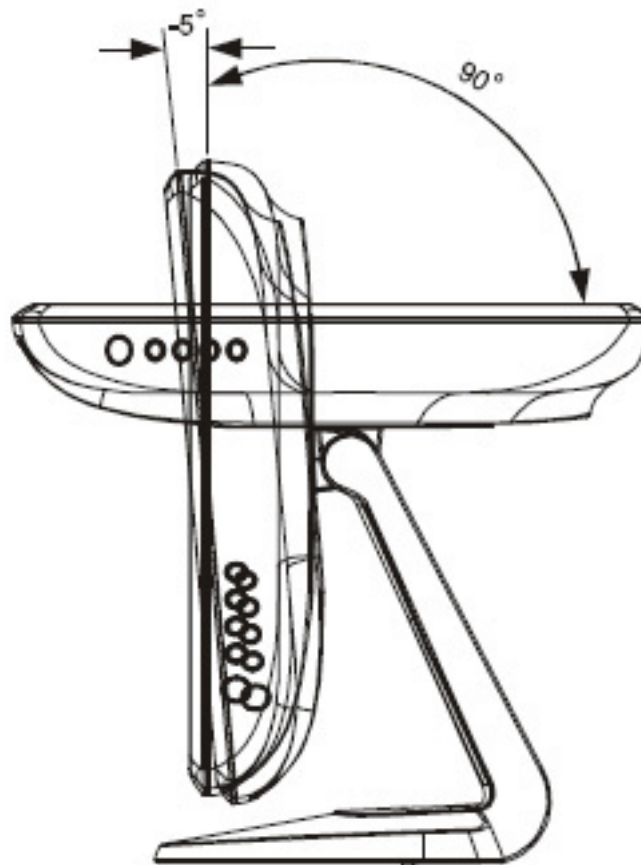

△ **CAUTION:** In order to protect the monitor, be sure to hold the base when adjusting the LCD, and take care not to touch the screen.

Locating the Rating Labels

The rating labels on the monitor provide the spare part number, product number, and serial number. You may need these numbers when contacting HP about the monitor model. The rating labels are located on the rear panel of the monitor display head.

4 Operating the Monitor

Installing the Monitor Driver

The CD that comes with the monitor contains monitor driver files you can install on your computer:

- an .INF (Information) file
- an .ICM (Image Color Matching) file

PDF Complete is supplied on this CD and can be installed from the menu.

 **NOTE:** If the monitor does not include a CD, the .INF and .ICM files can be downloaded from the HP monitors support Web site. See [Downloading from the Worldwide Web on page 11](#) in this chapter.

The Information File

The .INF file defines monitor resources used by Microsoft Windows operating systems to ensure monitor compatibility with the computer's graphics adapter.

This monitor is Microsoft Windows Plug and Play compatible and the monitor will work correctly without installing the .INF file. Monitor Plug and Play compatibility requires that the computer's graphic card is VESA DDC2 compliant and that the monitor connects directly to the graphics card. Plug and Play does not work through separate BNC type connectors or through distribution buffers/boxes.

The Image Color Matching File

The .ICM files are data files that are used in conjunction with graphics programs to provide consistent color matching from monitor screen to printer, or from scanner to monitor screen. The .ICM file contains a monitor color system profile. This file is activated from within graphics programs that support this feature.

 **NOTE:** The ICM color profile is written in accordance with the International Color Consortium (ICC) Profile Format specification.

Installing the .INF and .ICM Files

After you determine that you need to update, you can install the .INF and .ICM files from the CD or download them.

Installing from the CD

To install the .INF and .ICM files on the computer from the CD:

1. Insert the CD in the computer CD-ROM drive. The CD menu is displayed.
2. View the **Monitor Driver Software Readme** file.
3. Select **Install Monitor Driver Software**.
4. Follow the on-screen instructions.
5. Ensure that the proper resolution and refresh rates appear in the Windows Display control panel.

 **NOTE:** You may need to install the digitally signed monitor .INF and .ICM files manually from the CD in the event of an installation error. Refer to the Monitor Driver Software Readme file on the CD.

Downloading from the Worldwide Web

To download the latest version of .INF and .ICM files from the HP monitors support Web site:

1. Refer to <http://www.hp.com/support> and select the country region.
2. Follow the links for the monitor to the support page and download page.
3. Ensure the system meets the requirements.
4. Download the software by following the instructions.

Adjusting the Monitor

The monitor will unlikely require adjustment. However, variations in video output and application may require adjustments to optimize the quality of the display.

For best performance, the monitor should be operating in native resolution, that is 1024 x 768 at 60 -75 Hz. Use the Display control panel in Windows to choose 1024 x 768 resolution. Operating in other resolutions will degrade video performance.

All adjustments you make to the controls are automatically memorized. This feature saves you from having to reset your choices every time you unplug or power your monitor off and on. If there is a power failure, the monitor settings will not default to the factory specifications.

Front Panel Controls

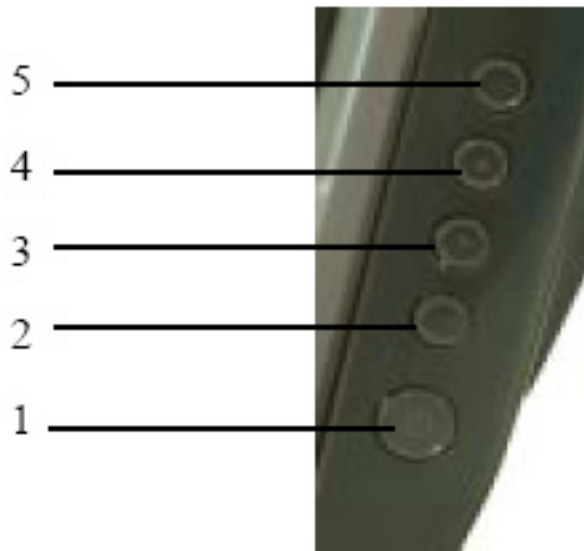



Table 4-1 Monitor Front Panel Controls

Control	Function
1 Power	Turns the monitor on or off.
2 Select	Selects the adjustment items from the OSD menus.
3 ▼	Enter the brightness adjustment. Decrease value of the adjustment item. Select item counter-clockwise.
4 ▲	Enters contrast adjustment. Increase value of the adjustment item. Select item.
5 Menu/Exit	Displays or exits the OSD menus.

Using the On-Screen Display

Use the On-Screen Display (OSD) to display and select OSD menu functions. To access the OSD, do the following:

1. Press the Menu button on the side panel to activate the OSD menu.
2. Use the up arrow or down arrow controls to move clockwise or counterclockwise through the menu. Press the Enter key on the keyboard, the parameter will be highlighted when selected.
3. To quit the OSD screen at any time during the operation, press the Menu button. If the OSD remains untouched for a short period of time, the OSD automatically disappears.

 **NOTE:** The OSD screen will disappear if no input activities are detected for 45 seconds.

OSD Menu Table

The following table lists the On-Screen Display (OSD) menu selections and their functional descriptions. Settings will be saved automatically after adjustments are made.

Table 4-2 OSD Menu

















Icon	OSD Control	Description
	Brightness	Increases or decreases brightness.
	Contrast	Increases or decreases contrast.
	H-Position	Adjusts the position of the screen image left and right.
	V-Position	Adjusts the position of the screen image up and down.
	Phase	Adjusts the focus of the display. This adjustment allows you to remove any horizontal noise and clear or sharpen the image of characters.
	Clock	Minimizes any vertical bars or strips visible on the screen background. Adjusting the Clock will also change the horizontal screen image.
	Sharpness	Adjusts the screen image to look sharper or soft.
	OSD H-Position	Moves the OSD position horizontally on the screen. When the up arrow button is pressed, the OSD menu will move to the right side of the screen. Likewise, when the down arrow button is pressed, the OSD control menu will move to the left side.
	OSD V-Position	Moves the OSD position vertically on the screen. When the up arrow button is pressed, the OSD menu will move to the top side of the screen. Likewise, when the down arrow button is pressed, the OSD control menu will move to the lower side.
	OSD Time	Adjusts the amount of time the OSD menu is displayed.
	Color Balance	Press the up arrow button or the down arrow button to select 9300, 6500, 5500, 7500 or USER. Only when selecting USER can you make adjustments to the R/G/B (red/green/blue) content. Press Enter to restore the factory default setting.
	Auto-Adjustment	Press Auto to enable this function. The Auto-Adjustment will automatically adjust V-Position, H-Position, Clock and Clock-Phase.
	Recall Defaults	Returns the monitor to its default settings.

Table 4-2 OSD Menu (continued)

Icon	OSD Control	Description
	OSD Language	Selects the language in which the OSD menu is displayed.
	Information Description	Indicates the current resolution, H-Frequency and V-Frequency.

 **NOTE:** When adjusting the Clock and Clock Phase values, if the monitor images become distorted, continue adjusting the values until the distortion disappears. To restore the factory settings, select the Recall Defaults menu in the on-screen display.

Identifying Monitor Conditions

Special messages will appear on the monitor screen when identifying the following monitor conditions:

- **Out of Range**—Indicates the monitor does not support the input signal because the resolution and/or refresh rate are set higher than the monitor supports.
- **No Input Signal**—Indicates the monitor is not receiving a video signal from the PC on the monitor video input connector. Check to determine if the PC or input signal source is off or in the power saving mode.
- **Check Video Cable**—Indicates the video cable is not properly connected to the computer.

Power Management System

The monitor is equipped with the power management function which automatically reduces the power consumption when not in use.

Mode	Power Consumption
On	<30 W
Sleep	<4 W
Off	<2 W

It is recommended that you switch the monitor off when it is not in use for a long period of time.

 **NOTE:** The monitor automatically goes through the power management system steps when it is idle. To release the monitor from the power management system, press any key on the keyboard or move the mouse or touch the touchscreen. In order for the touchscreen to bring the monitor from the power management system, the touchscreen function must be fully operational.

Monitor models using the APR driver do not support standby or sleep mode.

OSD and Power Lock/Unlock

The OSD feature can be locked and unlocked. The monitor is shipped with the OSD menu and power button in the unlocked position.

To lock the OSD menu:

1. Press the Menu button and up arrow button simultaneously until a window displays "OSD Unlock." Continue to hold the buttons down and the window toggles to "OSD Lock."
2. To unlock the OSD, repeat the above step until "OSD Unlock" is displayed.

To lock the power button:

1. Press the Menu button and down arrow button simultaneously until a window displays "Power Unlock." Continue to hold the buttons down until "Power Lock" displays.
2. To unlock the power button, repeat the above step until "Power Unlock" is displayed.

A Troubleshooting

Solving Common Problems

The following table lists possible problems, the possible cause of each problem, and the recommended solutions.

Problem	Possible Cause	Solution
Screen is blank.	Power cord is disconnected.	Connect the power cord.
	Power button on front panel of the monitor is turned off.	Press the front panel power button.
	Video cable is improperly connected.	Connect the video cable properly. Refer to Chapter 3, Setting Up the Monitor on page 5 for more information.
	Screen blanking utility is active.	Press any key on the keyboard or move the mouse to inactivate the screen blanking utility.
The monitor does not respond after you turn on the system.	Check power.	Check that the monitor's power switch is on. Turn off power and check the monitor's power cord and signal cable for proper connection.
Image appears blurred, indistinct, or too dark.	Brightness and contrast are too low.	Press the Menu button to display the OSD. Use the up arrow button or down arrow button to adjust the brightness and contrast scales as needed.
Screen flashes when initialized.		Turn the monitor off then turn it on again.
Check Video Cable is displayed on screen.	Monitor video cable is disconnected.	Connect the VGA cable to the VGA connector on the computer. Be sure that the computer power is off while connecting the video cable.
Out of Range is displayed on screen.	Video resolution and/or refresh rate are set higher than what the monitor supports.	Restart your computer and enter Safe Mode. Change your settings to a supported setting (see Recognizing Preset Display Resolutions on page 25 in Appendix B). Restart your computer so that the new settings take effect.

Touchscreen Tips

If you experience operational issues with the touchscreen system either during or after installation, use the tips below to help you determine the source of the problem.

- If “No Elo touchmonitor found” is displayed on the screen, install the latest drivers. Touchmonitors with the dual serial/USB interface require the latest drivers. If you are replacing an existing installation and see this problem, you should update your touchscreen driver with one from the Elo Web site **Driver and File Downloads** page.
- Be sure to calibrate the L5006tm touchscreen monitor. Touch response must be aligned to the video image (this is sometimes called calibration). Normally this need only be done when the touch drivers are initially installed.

 **NOTE:** The L5009tm LCD with APR technology has a fixed coordinate system that never changes over time, position or environmental changes. With APR, calibration is eliminated.

To calibrate the L5006tm touchscreen:

1. Click the Windows **Start** button.
2. Select **Settings > Control Panel** (on later operating systems the Settings step is omitted).
3. Open the Elo application by double-clicking the Elo icon.

On Windows XP it may be necessary to click the Show Classic View button on the left side of the screen to see the Elo icon.

4. Click the **Alignment/Calibration** button.

The Alignment/Calibration button is always on the General tab of the Elo Control Panel tab set. It may be titled Calibrate, Align or it may just be an icon (fingers and cross marks on a display).

5. Touch the target that is displayed in the upper left corner. The target will reappear in the lower right corner.
6. Touch the lower right target. The target will reappear in the upper right corner.
7. Touch the upper right target. The next screen is an alignment check.
8. On the alignment check screen, touch various places on the screen and see that the cursor jumps to the point of touch.

A progress bar displays the relative time remaining before the routine will time out; if time-out is reached, the routine is aborted and the new alignment points are not retained.

If response is correct, touch the **Accept** button - it may be a Yes button or a green check.

Clicking the **No** or redo arrow icon will display the targets again to rerun the alignment routine. Remember, you must click the **Accept** button to store the new alignment points.

If the touchscreen is not responding to touch, check your serial or USB connection by doing the following:

- **Serial Connection** - Run the comdump diagnostic utility to determine if the touchscreen, the serial touch controller, the computer's serial COM port and the associated cabling are connected and functioning properly. Download the latest version of comdump.exe (7K) from the Elo Web site Driver and Files Download page. You should save the file where it can be accessed easily - either to a floppy or to the root of your hard drive. Comdump is a DOS application, so if you are running one of the Windows operating systems you must either boot to a DOS boot diskette or disable the driver so you can access the COM port from a command prompt.
- **USB Connection** - If the Human Interface Device (HID) is not listed in Device Manager after a USB touchmonitor is connected, check to determine if a file named mouhid.sys is in the \windows (or winnt) \system32\drivers folder.
 - The file will be missing if a USB mouse has never been connected to the system.
 - If the file is not there, connect a USB mouse to the system or copy mouhid.sys from another system.
 - Once mouhid.sys is in the proper location, remove and reinstall the touch drivers.

If you have determined that the HID files are missing or corrupted ("Error installing mouse" when installing the HID drivers, and also a yellow "!" in Device Manager under Mouse), check that all of the following files are present in the \\winnt\system32\drivers folder:

- Hidusb.sys
- Hidclass.sys
- Hidparse.sys
- Mouhid.sys

If all the files are there, try replacing them with the same files from a known good system. It is suggested that you save the original files in a backup directory.

The touch can not be held longer than 10 seconds. IntelliTouch controllers have a built-in two minute untouch time-out. By default, the 4.20 Universal driver generates an untouch after 10 seconds of constant touch. The untouch time-out can be changed by modifying a registry key. This time-out will override any registry time-out value if the registry value exceeds 120 seconds (120000 milliseconds). To change the time-out time:

1. Run regedit or regedt32 (click **Start > Run**, enter **regedit**).
2. Drill down to **HKEY_LOCAL_MACHINE > SYSTEM > CurrentControlSet > Enum**.
 - a. For serial controllers: **SERENUM > ELOSERIAL > ***** > Device Parameters**.
 - b. For USB controllers: **HID > VID_04e7 > ***** > ***** > Device Parameters**.

 **NOTE:** The "*****" entries are id numbers used by the Windows operating system.

3. Double-click the **UntouchTimeOut** key. The Edit DWORD Value dialog box opens.
4. Click the **Decimal** radio button. Value displays in decimal (default: 10000).
5. Enter the delay time in milliseconds, 60000 is 60 seconds.

6. Exit regedit when done.
7. Shut Down and restart the machine. A restart is required before the setting will take effect.

A cursor is not visible. To make the cursor visible, first, open **Control Panel > Elo Touchscreen > Mode** tab. Check if the Hide arrow mouse pointer box is checked; if yes, un-check it and click OK. If a mouse is not installed on the computer, Shut Down the computer, install a mouse, then restart the computer. The cursor should now be visible. You may then Shut Down and remove the mouse, or leave it connected, as desired.

If connecting multiple monitor systems, all monitors must be configured to have independent resolution control (as in two monitors, each at 1024 x 786 resolution), rather than a single, large desktop (as in 2048 x 768). Multiple individual video cards are automatically set up as individual monitors. Some multiport video cards can be configured either way; in this case, the video driver must be set up properly. Once the multiport video has been properly configured, the Elo Universal driver should be removed and reinstalled. Some multiport video cards can only be configured as a single large desktop, and they will not work with Elo's multiple monitor driver setup.

Online Technical Support

For the online access to technical support information, self-solve tools, online assistance, community forums of IT experts, broad multivendor knowledge base, monitoring and diagnostic tools, go to <http://www.hp.com/support>

Preparing to Call Technical Support

If you cannot solve a problem using the troubleshooting tips in this section, you may need to call technical support. Have the following information available when you call:

- The monitor
- Monitor model number
- Serial number for the monitor
- Purchase date on invoice
- Conditions under which the problem occurred
- Error messages received
- Hardware configuration
- Hardware and software you are using

B Technical Specifications

 **NOTE:** All performance specifications are provided by the component manufacturers. Performance specifications represent the highest specification of all HP's component manufacturers' typical level specifications for performance and actual performance may vary either higher or lower.

HP L5006tm Touchscreen

Table B-1 HP L5006tm Specifications

LCD Display	38.1 cm	15 inches
Type	TFT LCD	
Display Size	304 (H) x 228 (V) mm	12.0 (H) x 9.0 (V) in
Pixel Pitch	0.297 (H) x 0.297 (V) mm	0.01 (H) x 0.01 (V) in
Display Mode	VGA 640 x 350 (70Hz) VGA 720 x 400 (70Hz) VGA 640 x 480 (60 / 72 / 75Hz) SVGA 800 x 600 (56 / 60 / 72 / 75Hz) XGA 1024 x 768 (60 / 70 / 75Hz)	
Maximum Resolution	XGA 1024 x 768 at 75Hz	
Contrast Ratio	400 : 1 (typical)	
Brightness	Typical 230 Cd/m ² ; Min 184 Cd/m ²	
Response Time	Tr: 5 ms Tf: 12 ms Typical	
Display Color	16.2M	
Viewing Angle	Vertical -60° ~ +40° Horizontal -60° ~ +60°	
Input Signal		
Video	R.G.B. Analog 0.7Vp-p, 75 Ohms	
Sync	TTL Positive or Negative	
Signal Connector	Mini D-Sub 15 pin	
Side Control	Menu, up arrow, down arrow, Select, Power	

Table B-1 HP L5006tm Specifications (continued)

OSD	Contrast, Brightness, H-Position, V-Position, Color Temperature, Phase, Clock, OSD Time, Recall, Language	
Plug & Play	DDC1/2B	
Touch Panel	IntelliTouch Surface Acoustic Wave (SAW) technology	
Power	Input AC 100-240V, 50-60Hz	
Operating Conditions		
Temperature (Operating)	0° C to 40° C (32° F to 104° F)	
Temperature (Storage)	-20°C to 60°C (-4°F to 140°F)	
Humidity	20% ~ 80% (No Condensation)	
Altitude	To 3657.6 meters (12,000 feet)	
Dimensions		
Width	350 mm	13.8 in
Height (includes base)	310 mm	12.2 in
Depth (includes base)	175 mm	6.9 in
Weight		
Actual	4.8 kg	10.6 lb
Shipping	7.0 kg	15.4 lb

HP Compaq L5009tm Touchscreen

Table B-2 HP Compaq L5009tm Specifications

LCD Display	38.1 cm	15 inches
Type	TFT LCD	
Display Size	304 (H) x 228 (V) mm	12.0 (H) x 9.0 (V) in
Pixel Pitch	0.297 (H) x 0.297 (V) mm	0.01 (H) x 0.01 (V) in
Display Mode	VGA 640 x 350 (70Hz) VGA 720 x 400 (70Hz) VGA 640 x 480 (60 / 72 / 75Hz) SVGA 800 x 600 (56 / 60 / 72 / 75Hz) XGA 1024 x 768 (60 / 70 / 75Hz)	
Maximum Resolution	XGA 1024 x 768 at 75Hz	
Contrast Ratio	450 : 1 (typical)	
Brightness	Typical 230 Cd/m ² ; Min 184 Cd/m ²	
Response Time	Tr: 5 ms Tf: 12 ms Typical	

Table B-2 HP Compaq L5009tm Specifications (continued)

Display Color	16.2M	
Viewing Angle	Vertical -60° ~ +40° Horizontal -60° ~ +60°	
Input Signal		
Video	R.G.B. Analog 0.7Vp-p, 75 Ohms	
Sync	TTL Positive or Negative	
Signal Connector	Mini D-Sub 15 pin	
Side Control	Menu, up arrow, down arrow, Select, Power	
OSD	Contrast, Brightness, H-Position, V-Position, Color Temperature, Phase, Clock, OSD Time, Recall, Language	
Plug & Play	DDC1/2B	
Touch Panel	Acoustic Pulse Recognition (APR) Technology	
Power	Input AC 100-240V, 50-60Hz	
Operating Conditions		
Temperature (Operating)	0° C to 40° C (32° F to 104° F)	
Temperature (Storage)	-20°C to 60°C (-4°F to 140°F)	
Humidity	20% ~ 80% (No Condensation)	
Altitude	To 3657.6 meters (12,000 feet)	
Dimensions		
Width	350 mm	13.8 in
Height (includes base)	310 mm	12.2 in
Depth (includes base)	175 mm	6.9 in
Weight		
Actual	4.8 kg	10.6 lb
Shipping	7.0 kg	15.4 lb

IntelliTouch Surface Acoustic Wave Technology

Table B-3 IntelliTouch Specifications

Input Method	Finger or gloved hand (cloth, leather or rubber) activation.
Mechanical Positional Accuracy	Standard deviation of error is less than 2.03 mm (0.080 in). Equates to less than $\pm 1\%$.
Touchpoint Density	More than 15,500 touchpoints/cm ² (100,000 touchpoints/in ²).
Touch Activation Force	Typically less than 85 grams (3 ounces).
Surface Durability	Surface durability is that of glass, Mohs' hardness rating of 7.
Expected Life Performance	No known wear-out mechanism, as there are no layers, coatings, or moving parts. IntelliTouch technology has been operationally tested to more than 50 million touches in one location without failure, using a stylus similar to a finger
Sealing	Unit is sealed to protect against splashed liquids, dirt, and dust.
Optical Light Transmission (per ASTM D1003)	up to 92%
Visual Resolution	All measurements made using USAF 1951 Resolution Chart, under 30X magnification, with test unit located approximately 38 mm (1.5 in) from surface of resolution chart Clear surface: Excellent, with no noticeable degradation. Antiglare surface: 6:1 minimum.
Gloss (per ASTM D2457 using a 60- degree gloss meter)	Antiglare surface: curved or flat: 95 ± 15 gloss units or 65 ± 15 gloss units; Clear surface: N/A
Environmental Chemical Resistance	The active area of the touchscreen is resistant to all chemicals that do not affect glass, such as: <ul style="list-style-type: none"> • Acetone • Toluene • Methyl ethyl ketone • Isopropyl alcohol • Methyl alcohol • Ethyl acetate • Ammonia-based glass cleaners • Gasoline • Kerosene • Vinegar
Electrostatic Protection (per EN 61 000-4-2, 1995)	Meets Level 4 (15 kV air/8 kV contact discharges).

Acoustic Pulse Recognition Technology

Table B-4 APR Specifications

Input Method	Finger, finger nail, solid stylus or gloved hand (cloth, leather or rubber) activation
Mechanical Positional Accuracy	1% maximum error
Resolution Accuracy	Touchpoint density is based on controllers resolution of 4096 x 4096
Touch Activation Force	Typically 2 to 3 ounces (55 to 85 grams)
Controller	Board: USB 1.1
Optical Light Transmission	90% +/- 5%
Environmental Chemical Resistance	<p>The touch activation area of the touchscreen is resistant to chemicals that do not affect glass such as:</p> <ul style="list-style-type: none"> • Acetone • Toluene • Methyl ethyl ketone • Isopropyl alcohol • Methyl alcohol • Ethyl Acetate • Ammonia-based glass cleaners • Gasoline • Kerosene • Vinegar
Surface Durability Expected Life	<p>Surface durability is that of glass, Mohs' hardness rating of 7. No known wear-out mechanism, as there are no layers, coatings or moving parts. APR technology has been operationally tested to more than 50 million touches in one location without failure, using a stylus similar to a finger.</p>

Recognizing Preset Display Resolutions

The display resolutions listed below are the most commonly used modes and are set as factory defaults. This monitor automatically recognized these preset modes and they will appear properly sized and centered on the screen.

HP L5006tm and L5009tm

Table B-5 Factory Preset Modes

Preset	Pixel Format	Horz Freq (kHz)	Band Width (MHz)
1	VGA 640 x 350 70Hz	31.5	28.322
2	VGA 720 x 400 70Hz	31.47	28.322
3	VGA 640 x 480 60Hz	31.47	25.175
4	MAC 640 x 480 66Hz	35.00	32.24
5	VESA 640 x 480 72Hz	37.86	31.5
6	VESA 640 X 480 75Hz	37.50	31.5
7	VESA 800 X 600 56Hz	35.16	36
8	VESA 800 X 600 60Hz	37.88	40
9	VESA 800 X 600 75Hz	46.88	49.5
10	VESA 800 x 600 72Hz	48.08	50
11	MAC 832 x 624 75Hz	49.72	57.283
12	VESA 1024 x 768 65Hz	48.36	65
13	SUN 1024 x 768 65Hz	52.45	70.49
14	VESA 1024 x 768 70Hz	56.48	75
15	VESA 1024 x 768 75Hz	60.02	78.75

Entering User Modes

The video controller signal may occasionally call for a mode that is not preset if:

- You are not using a standard graphics adapter.
- You are not using a preset mode.

If this occurs, you may need to readjust the parameters of the monitor screen by using the on-screen display. Your changes can be made to any or all of these modes and saved in memory. The monitor automatically stores the new setting, then recognizes the new mode just as it does a preset mode. In addition to the 15 factory preset, there are 7 user modes that can be entered and stored.

The only condition to store as a user mode is the new display information must have 1 KHz difference for horizontal frequency or 1 Hz for vertical frequency or the sync signal polarities are different from the default modes.

Energy Saver Feature

When the monitor is in its normal operating mode, the monitor uses less than 21 watts and the Power light is green.

The monitor also supports a reduced power state. The reduced power state will be entered into if the monitor detects the absence of either the horizontal sync signal and/or the vertical sync signal. Upon detecting the absence of these signals, the monitor screen is blanked, the backlight is turned off, and the power light is turned amber. When the monitor is in the reduced power state, the monitor will utilize less than 2 watts of power. There is a brief warm up period before the monitor will return to its normal operating mode.

Refer to the computer manual for instructions on setting energy saver features (sometimes called power management features).

 **NOTE:** The above power saver feature only works when connected to computers that have energy saver features.

By selecting the settings in the monitor's Energy Saver utility, you can also program the monitor to enter into the reduced power state at a predetermined time. When the monitor's Energy Saver utility causes the monitor to enter the reduced power state, the power light blinks amber.

C Agency Regulatory Notices

Federal Communications Commission Notice

This equipment has been tested and found to comply with the limits for a Class B digital device, pursuant to Part 15 of the FCC Rules. These limits are designed to provide reasonable protection against harmful interference in a residential installation. This equipment generates, uses, and can radiate radio frequency energy and, if not installed and used in accordance with the instructions, may cause harmful interference to radio communications. However, there is no guarantee that interference will not occur in a particular installation. If this equipment does cause harmful interference to radio or television reception, which can be determined by turning the equipment off and on, the user is encouraged to try to correct the interference by one or more of the following measures:

- Reorient or relocate the receiving antenna.
- Increase the separation between the equipment and the receiver.
- Connect the equipment into an outlet on a circuit different from that to which the receiver is connected.
- Consult the dealer or an experienced radio or television technician for help.

Modifications

The FCC requires the user to be notified that any changes or modifications made to this device that are not expressly approved by Hewlett Packard Company may void the user's authority to operate the equipment.

Cables

Connections to this device must be made with shielded cables with metallic RFI/EMI connector hoods to maintain compliance with FCC Rules and Regulations.

Declaration of Conformity for Products Marked with the FCC Logo (United States Only)

This device complies with Part 15 of the FCC Rules. Operation is subject to the following two conditions:

1. This device may not cause harmful interference.
2. This device must accept any interference received, including interference that may cause undesired operation.

For questions regarding the product, contact:

Hewlett Packard Company
P. O. Box 692000, Mail Stop 530113
Houston, Texas 77269-2000
Or, call 1-800-HP-INVENT (1-800 474-6836)

For questions regarding this FCC declaration, contact:

Hewlett Packard Company
P. O. Box 692000, Mail Stop 510101
Houston, Texas 77269-2000
Or, call (281) 514-3333

To identify this product, refer to the Part, Series, or Model number found on the product.

Canadian Notice

This Class B digital apparatus meets all requirements of the Canadian Interference-Causing Equipment Regulations.

Avis Canadien

Cet appareil numérique de la classe B respecte toutes les exigences du Règlement sur le matériel brouilleur du Canada.

European Union Regulatory Notice

This product complies with the following EU Directives:

- Low Voltage Directive 2006/95/EC
- EMC Directive 2004/108/EC

Compliance with these directives implies conformity to applicable harmonized European standards (European Norms) which are listed on the EU Declaration of Conformity issued by Hewlett-Packard for this product or product family.

This compliance is indicated by the following conformity marking placed on the product:

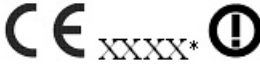
 <small>This marking is valid for non-Telecom products and EU harmonized Telecom products (e.g. Bluetooth).</small>	 <small>This marking is valid for EU non-harmonized Telecom products. *Notified body number (used only if applicable - refer to the product label).</small>
<small>This marking is valid for non-Telecom products and EU harmonized Telecom products (e.g. Bluetooth)</small>	<small>This marking is valid for EU non-harmonized Telecom products. *Notified body number (used only if applicable — refer to the product label).</small>

German Ergonomics Notice

HP products which bear the "GS" approval mark, when forming part of a system comprising HP brand computers, keyboards and monitors that bear the "GS" approval mark, meet the applicable ergonomic requirements. The installation guides included with the products provide configuration information.

Japanese Notice

この装置は、クラスB情報技術装置です。この装置は、家庭環境で使用することを目的としていますが、この装置がラジオやテレビジョン受信機に近接して使用されると、受信障害を引き起こすことがあります。取扱説明書に従って正しい取り扱いをして下さい。

VCCI-B

Korean Notice

B급 기기
(가정용 방송통신기기)

이 기기는 가정용(B급)으로 전자파적합등록을 한 기기로서 주로 가정에서 사용하는 것을 목적으로 하며, 모든 지역에서 사용할 수 있습니다.

Power Cord Set Requirements

The monitor power supply is provided with Automatic Line Switching (ALS). This feature allows the monitor to operate on input voltages between 100–120V or 200–240V.

The power cord set (flexible cord or wall plug) received with the monitor meets the requirements for use in the country where you purchased the equipment.

If you need to obtain a power cord for a different country, you should purchase a power cord that is approved for use in that country.

The power cord must be rated for the product and for the voltage and current marked on the product's electrical ratings label. The voltage and current rating of the cord should be greater than the voltage and current rating marked on the product. In addition, the cross-sectional area of the wire must be a minimum of 0.75 mm² or 18 AWG, and the length of the cord must be between 6 feet (1.8 m) and 12 feet (3.6 m). If you have questions about the type of power cord to use, contact an authorized HP service provider.

A power cord should be routed so that it is not likely to be walked on or pinched by items placed upon it or against it. Particular attention should be paid to the plug, electrical outlet, and the point where the cord exits from the product.

Japanese Power Cord Requirements

For use in Japan, use only the power cord received with this product.

△ **CAUTION:** Do not use the power cord received with this product on any other products.

Product Environmental Notices

Materials Disposal

This HP product contains mercury in the fluorescent lamp in the display LCD that might require special handling at end-of-life.

Disposal of this material can be regulated because of environmental considerations. For disposal or recycling information, contact the local authorities or the Electronic Industries Alliance (EIA) <http://www.eiae.org>.

Disposal of Waste Equipment by Users in Private Household in the European Union



This symbol on the product or on its packaging indicates that this product must not be disposed of with your household waste. Instead, it is your responsibility to dispose of your waste equipment by handing it over to a designated collection point for the recycling or waste electrical and electronic equipment. The separate collection and recycling of your waste equipment at the time of disposal will help to conserve natural resources and ensure that it is recycled in a manner that protects human health and the environment. For more information about where you can drop off your waste equipment for recycling, please contact the local city office, the household waste disposal service or the shop where you purchased the product.

HP Recycling Program

HP encourages customers to recycle used electronic hardware, HP original print cartridges, and rechargeable batteries. For more information about recycling programs, go to <http://www.hp.com/recycle>.

Chemical Substances

HP is committed to providing our customers with information about the chemical substances in our products as needed to comply with legal requirements such as REACH (*Regulation EC No 1907/2006 of the European Parliament and the Council*). A chemical information report for this product can be found at: <http://www.hp.com/go/reach>

Restriction of Hazardous Substances (RoHS)

A Japanese regulatory requirement, defined by specification JIS C 0950, 2005, mandates that manufacturers provide Material Content Declarations for certain categories of electronic products offered for sale after July 1, 2006. To view the JIS C 0950 material declaration for this product, visit <http://www.hp.com/go/jisc0950>.

2008年、日本における製品含有表示方法、JISC0950が公示されました。製造事業者は、2006年7月1日以降に販売される電気・電子機器の特定化学物質の含有につきまして情報提供を義務付けられました。製品の部材表示につきましては、www.hp.com/go/jisc0950を参照してください。

有毒有害物质/元素名称及含量表

根据中国 《电子信息产品污染控制管理办法》

液晶显示器

部件名称	有毒有害物质和元素					
	铅 (Pb)	汞 (Hg)	镉 (Cd)	六价铬 (Cr(VI))	多溴联苯 (PBB)	多溴二苯醚 (PBDE)
液晶显示器显示面板	X	X	○	○	○	○
机箱/其它	X	○	○	○	○	○

CRT 显示器

部件名称	有毒有害物质和元素					
	铅 (Pb)	汞 (Hg)	镉 (Cd)	六价铬 (Cr(VI))	多溴联苯 (PBB)	多溴二苯醚 (PBDE)
阴极射线管	X	○	○	○	○	○
机箱/其它	X	○	○	○	○	○

O: 表示该有毒或有害物质在该部件所有均质材料中的含量均在 SJ/T11363-2006 标准规定的限量要求以下。

X: 表示该有毒或有害物质至少在该部件所用的某一均质材料中的含量超出 SJ/T11363-2006 标准规定的限量要求。

表中标有“X”的所有部件都符合欧盟 RoHS 法规 — “欧洲议会和欧盟理事会 2003 年 1 月 27 日关于电子电器设备中限制使用某些有害物质的 2002/95/EC 号指令”。

注：环保使用期限的参考标识取决于产品正常工作的温度和湿度等条件。

Turkey EEE Regulation

In Conformity with the EEE Regulation

EEE Yönetmeliğine Uygundur

D Native Resolution

The native resolution of a monitor is the resolution level at which the LCD panel is designed to perform best. The native resolution is 1024 x 768 for the 15 inch size. In almost all cases, screen images look best when viewed at their native resolution. You can lower the resolution setting of a monitor but not increase it.

Input Video	15" LCD
640 x 480 (VGA\S)	Transforms input format to 1024 x 768
800 x 600 (SVGA)	Transforms input format to 1024 x 768
1024 x 768 (XGA)	Displays in Native Resolution

The native resolution of an LCD is the actual number of pixels horizontally in the LCD by the number of pixels vertically in the LCD. LCD resolution is usually represented by the following symbols:

VGA	640 x 480
SVGA	800 x 600
XGA	1024 x 768
SXGA	1280 x 1024
UXGA	1600 x 1200

As an example, a SVGA resolution LCD panel has 800 pixels horizontally by 600 pixels vertically. Input video is also represented by the same terms. XGA input video has a format of 1024 pixels horizontally by 768 pixels vertically. When the input pixels contained in the video input format match the native resolution of the panel, there is a one to one correspondence of mapping of input video pixels to LCD pixels. As an example, the pixel in column 45 and row 26 of the input video is in column 45 and row 26 of the LCD. For the case when the input video is at a lower resolution than the native resolution of the LCD, the direct correspondence between the video pixels and the LCD pixels is lost. The LCD controller can compute the correspondence between video pixels and LCD pixels using algorithms contained on its controller. The accuracy of the algorithms determines the fidelity of conversion of video pixels to LCD pixels. Poor fidelity conversion can result in artifacts in the LCD displayed image such as varying width characters.