



User Manual

20X Full HD High Speed Dome Network Camera

Preface

D-Link reserves the right to revise this publication and to make changes in the content hereof without obligation to notify any person or organization of such revisions or changes. Information in this document may become obsolete as our services and websites develop and change. Please refer to the www.mydlink.com website for the most current information.

Manual Revisions

Revision	Date	Description
1.0	March 20, 2013	DCS-6915 Revision A1 with firmware version 1.00
1.1	April 18, 2013	DCS-6915 Revision A2 with firmware version 1.00

Trademarks

D-Link and the D-Link logo are trademarks or registered trademarks of D-Link Corporation or its subsidiaries in the United States or other countries. All other company or product names mentioned herein are trademarks or registered trademarks of their respective companies.

Copyright © 2013 D-Link Corporation.

All rights reserved. This publication may not be reproduced, in whole or in part, without prior expressed written permission from D-Link Corporation.

Table of Contents

Product Overview.....	5	IP Settings.....	36
Package Contents.....	5	Port and Access Name Settings.....	38
Introduction.....	6	Dynamic DNS	39
System Requirements	6	HTTPS.....	40
Features.....	7	Access List.....	42
Hardware Overview	8	Advanced Settings	43
Connections Panel	8	Event Management	45
Assembly and Installation	9	Motion Detection	45
Manual Hardware Installation.....	9	DI and DO	46
Standard or Mini Pendant Mount.....	14	Event Settings	47
Ceiling Mounting - Straight Tube.....	15	Recording	52
Software Installation	16	Recording Settings.....	52
Viewing Your Internet Camera	19	Local Storage.....	53
Advanced Configuration.....	20	PTZ Control	54
Live Video	20	Preset Point.....	54
PTZ Control Panel	22	Cruise Line.....	55
Client Settings.....	24	Auto Pan.....	56
Setup	25	Sequence Line.....	57
Standard Setup.....	25	Home Function.....	58
Advanced Setup.....	26	Tilt Range.....	58
System Overview	27	Advanced Settings	59
Audio and Video.....	28	System	60
Video Settings.....	28	User Settings	60
Image Settings.....	31	Device Settings.....	61
Audio Settings	34	Time and Date.....	62
Day and Night Settings.....	35	Maintenance.....	63
Network.....	36	Parameter List	64

System Log	64
Technical Specifications	65
Connection Panel Pin Definition	69

Product Overview

Package Contents



DCS-6915 Speed Dome Network Camera



Waterproof Collar



CD-ROM with User Manual and software



Power Adapter



Power Cable



Lubricant



Quick Installation Guide



Cap



Screws



Screwdriver



Mini Pendant

If any of the above items are missing, please contact your reseller.

Note: Using a power supply with a different voltage than the one included with your product will cause damage and void the warranty for this product.

Introduction

The DCS-6915 20X Full HD High Speed Dome Network Camera is a high-definition professional surveillance and security solution suitable for small, medium, and large enterprises. The DCS-6915 features a 3 megapixel sensor capable of Full HD 1080P resolution, allowing for very clear surveillance footage to be taken. The powerful 20X optical zoom and 10X digital zoom ensure that you can see even the smallest details with ease.

The included D-ViewCam camera management software allows you to view up to 32 cameras on a single computer screen from a central location, set e-mail alert notifications, create recording schedules, and use motion detection or digital input devices to trigger automated e-mail alerts that instantly inform administrators of unusual activities while recording directly to a hard drive. D-ViewCam™ also allows users to upload a floor plan to create a realistic layout of the premises where cameras are located, further simplifying the management process.

System Requirements

- Operating System: Microsoft Windows[®], 2000, XP, Vista, 7
- Memory : At least 256MB of memory (512MB recommended)
- Web Browser: Internet Explorer 7.x or higher
- VGA card resolution: SVGA or XGA (1024x768 or above)
- CPU: 1.7GHz or above (2.8GHz plus processor with 512MB memory and a 32MB video card is required for multiple camera viewing and recording in IP surveillance program)
- An SD memory card (optional) is required for recording to onboard storage. SDHC Class 6 or above is recommended.
- An available Ethernet connection

Features

360 Degree Full HD Surveillance

The DCS-6915 provides superb 360 degree Full HD industry standard 16:9 wide screen video for IP surveillance. The pan, tilt and zoom (PTZ) controls enable comprehensive wide area surveillance with proportional tilt control making it easy to precisely adjust the camera's view as the panning speed is automatically slowed to improve camera tracking and control. Additionally, PTZ presets allow the camera to automatically monitor specified areas along predefined paths. Together these features mean a single camera can provide 360 degree coverage of a large area with ease.

Remote Monitoring Utility

The D-ViewCam application adds enhanced features and functionality for the Network Camera and allows administrators to configure and access the Network Camera from a remote site via Intranet or Internet. Other features include image monitoring, recording images to a hard drive, viewing up to 32 cameras on one screen, and taking snapshots.

Remote Zoom & Focus The remote focus function eliminates the need for manual focusing at the camera position and allowing the user to make key adjustments from any computer. The remote zoom functionality allows the user to make final adjustments to the zoom from the computer. It provides a convenient way to ensure that the viewing angle is optimized for the scene and required need for resolution.

Built for Tough Environments

Specially designed for use in challenging environments the DCS-6915 has a toughened metal, industry-certified IK-10 (vandal-proof) and IP-66 (weather-proof) housing. This means that it is able to withstand sudden high impacts, as well as adverse weather conditions. The camera apparatus is housed in a weatherproof enclosure (IP-66 standard), and features a built-in heater and fan which enable the camera to operate in extreme environments at temperatures ranging from -40 to 50 °C (-49 to 122 °F).

Wide Dynamic Range (WDR)

The Wide Dynamic Range (WDR) function of a camera provides clear images even under backlit conditions where the intensity of illumination can vary significantly. The DCS-6915 is recommended for extreme high-contrast environments. For example, when placed indoors, the DCS-6915 will adjust itself to the intense sunlight that may be streaming in through a nearby window. This makes it an ideal solution for security applications.

Removable IR Cut Filter for Continuous Monitoring

The IR Cut Filter can be manually applied, or set to automatically adjust based on lighting conditions. This feature enables the camera to capture crisp color images during the daytime, and grayscale images in low-light.

Flexible Connectivity

The DCS-6915 includes input and output ports for connectivity to external devices such as IR sensors, switches, and alarm relays.

Hardware Overview

Mounting Point

This part of the cap is used to mount the dome camera enclosure.

Cap

This cap covers the Connection Panel.

Optical Cover

This clear dome protects the camera apparatus.



Connections Panel

Reset

The reset button can be used to reset the system or restore the factory default settings. To reset, simply press and hold the button for 10 seconds.

Power Socket

This 3 pin socket accepts the power cable.

RJ45 connector

Connect your category 5 Ethernet cable to this port. The Green Link Light indicates a good network connection. The Orange Light indicates network activity.

Alarm I/O

Two digital alarm outputs and four digital alarm inputs.

Audio I/O

One audio input and one audio output.

MicroSD card slot

Insert a MicroSD card for local storage.

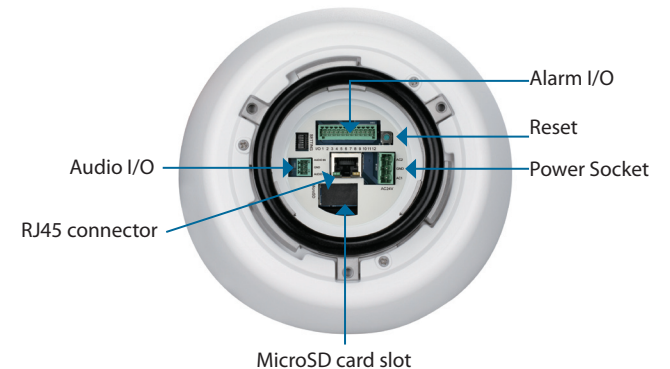

Assembly and Installation

Manual Hardware Installation

Step 1

Unpack the DCS-6915 and remove the dome camera unit.



Step 2

Remove the protective cover and PE sheet.



Step 3

Apply some lubricant on the cover's waterproof seal to make the installation process smoother. Attach the optical cover to the camera body.

The small protrusions on the cover must align with the four holes on the camera body.



Step 4

Gently press down the dome cover with two hands on the side of it.

Warning: DO NOT press down on the optical cover. This might cause damage to the camera.



Step 5

Screw the dome cover and body together.



Step 6

Insert the power connector into the opening on the cap.



Step 7

Connect the 3-pin connector to the slot on the camera enclosure. The connector will lock into place.



Step 8

Connect the power cable to the power adapter.



Step 9

Connect one end of the CAT 5 Ethernet cable to the RJ-45 connector of the camera enclosure, and the other end of the cable to your network.

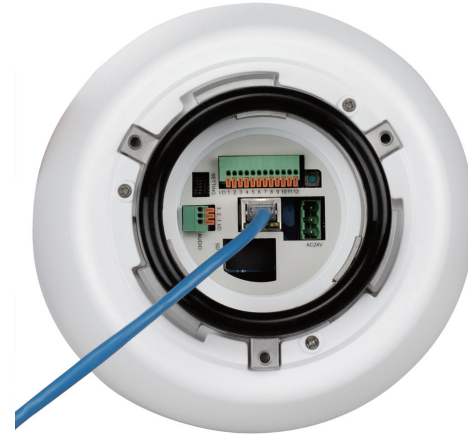

Step 10

Insert a MicroSD card for local storage of recorded images and video.

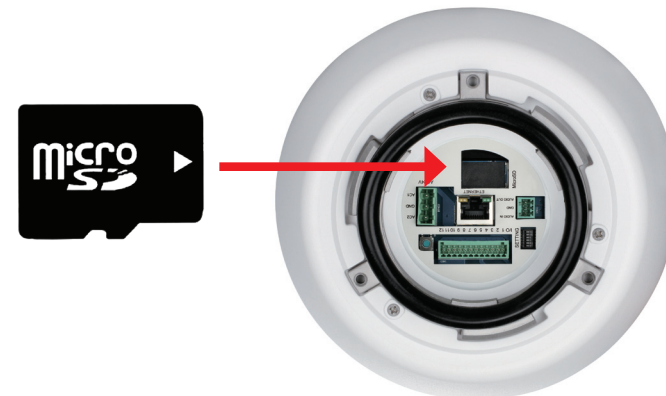

Step 11

Plug the power cable into a wall outlet.

Standard or Mini Pendant Mount

Follow the steps below to mount the camera enclosure with the pendant mount.

1. Make a cable entry hole on the wall to recess the cables. Alternatively, cables can be threaded through the cable entry hole on the mounting plate.
2. To prevent insects from entering the pendant mount, you may block the cable entry hole with the supplied sponge in two different ways.
3. Thread the cables through the pendant mount and affix the pendant mount on the wall with screws and screw anchors (not supplied).
4. Attach the waterproof collar to the pendant mount.
5. Thread the cables through the cap and affix it to the pendant mount with the supplied screws and washers.
6. Connect the cables to the camera enclosure. Attach the camera enclosure to the mount and affix it with the supplied bolt.

Note: After threading the cables, please block the cable entry hole with the supplied sponges to prevent insects from entering the tube.

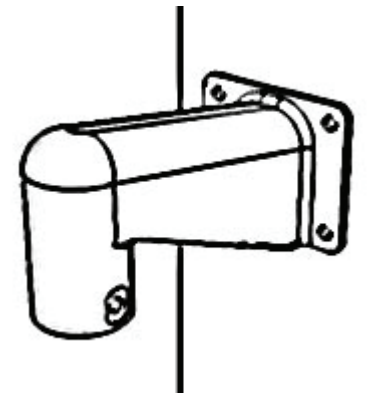
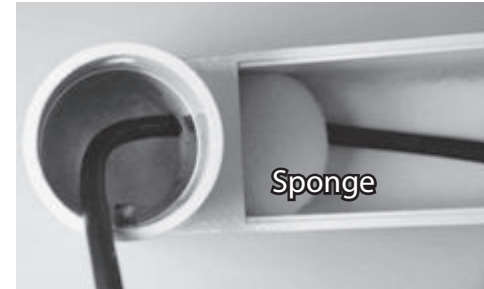

Ceiling Mounting - Straight Tube

Follow the steps below to mount the camera enclosure with the straight tube.

1. Ensure that the ceiling can support the weight of the camera enclosure and straight tube.
2. Make a cable entry hole on the ceiling.
3. Affix the straight tube to the ceiling with screws and screw anchors (not supplied).
4. Attach the waterproof collar to the straight tube.
5. Thread the cables through the straight tube and the cap.
6. Affix the cap to the straight tube with the supplied screws and washers. Attach the waterproof collar around the junction of the straight tube and cap.
7. Connect the cables to the camera enclosure. Attach the camera enclosure to the cap and affix it with the supplied bolt.

Note: After threading the cables, please block the cable entry hole with the supplied sponges to prevent insects from entering the tube.

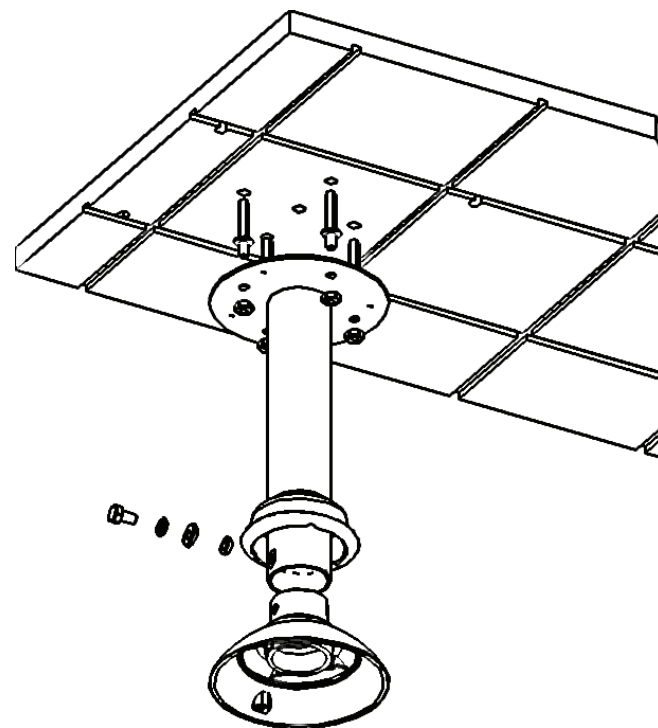

Software Installation

Step 1

Insert the Installation CD-ROM into your computer's optical drive to start the autorun program.

The CD-ROM will open the Camera Installation Wizard. The Setup Wizard will guide you through the installation process to configuring your camera.

Note:

If the autorun program does not automatically start on your computer, go to Windows, click **Start > Run**. In the Run command box type **D:\DCS6915.exe**, where D: represents your CD-ROM drive.



Step 2

Accept the End User Licence Agreement and follow the on screen prompts to install the Camera Installation Wizard.

Step 3

Select your camera from the list, then click **Wizard**. If you have multiple cameras, you can identify them by the MAC ID printed on the label on the back of your camera.



Step 4

By default the **Admin ID** is "admin" and the password is blank.

It is recommended that you create and confirm a password for your device. Click **Next** to continue.

The screenshot shows the 'Set up an Admin ID and Password to secure your camera.' screen. It features two columns of input fields. The first column has 'Admin ID' and 'Change' (checkbox) fields. The second column has 'Password' and 'Change' (checkbox) fields. Below these are 'New ID', 'Reconfirm', 'New Password', and 'Reconfirm' fields. At the bottom right are 'Back', 'Next', and 'Exit' buttons.

Step 5

Select **Static IP** if your Internet Service Provider has provided you with connection settings, or if you wish to set a static address within your home network. Enter the correct configuration information and click **Next** to continue.

Note: Select DHCP if you are unsure of which settings to choose.

Click **Next** to continue.

The screenshot shows the 'Set IP Address' screen. It has radio buttons for 'DHCP' and 'Static IP'. Below are input fields for 'IP Address', 'Subnet Mask', 'Default Gateway', 'Primary DNS', and 'Secondary DNS'. At the bottom right are 'Back', 'Next', and 'Exit' buttons.

Step 6

Confirm your camera login details and IP address details and click **Restart**.

The LED on the front of the DCS-6915 will blink, then turn solid green once it successfully connects to your network.

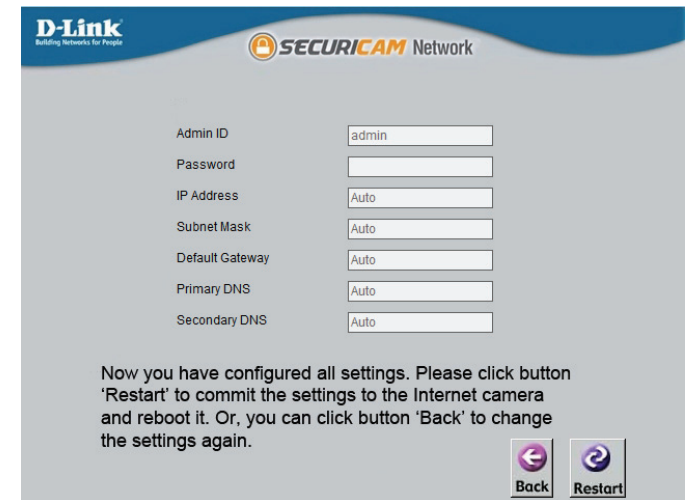

Step 7

Your DCS-6915 camera is now set up, Click **Exit** to exit the wizard and can skip to "Advanced Configuration" on page 20 for advanced configuration of your camera.



Viewing Your Internet Camera

Click the button labeled **Link** to access the web configuration. The Setup Wizard will automatically open your web browser to the IP address of the DCS-6915, in this example it is http://192.198.0.20. Your camera may have a different IP Address.



Enter **admin** as the default username and leave the password blank. Click **OK** to continue.

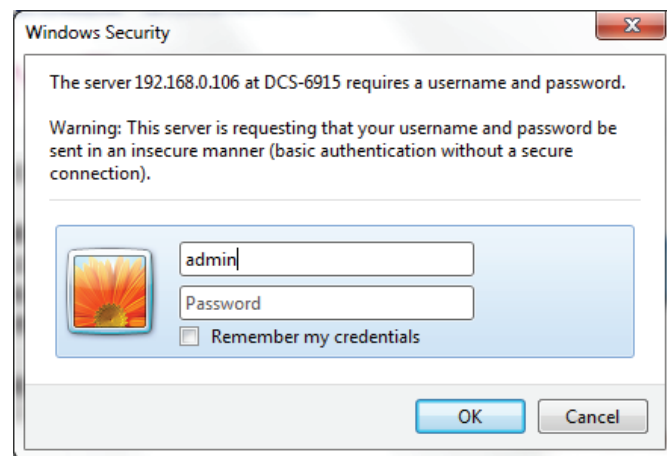





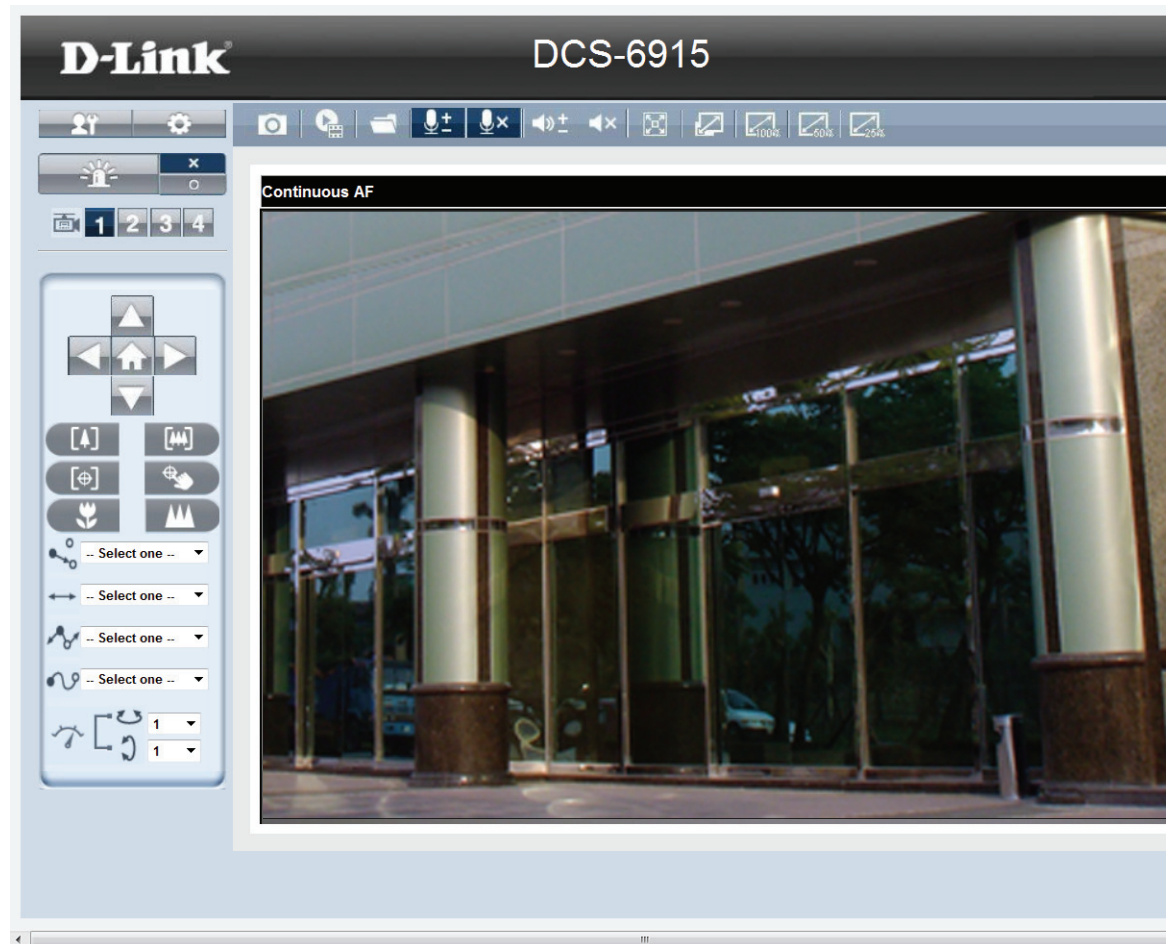

Advanced Configuration

Live Video



When you connect to the camera's web interface you will see the following page. This is the Live Video page which will allow you to view the camera's video feed and control basic camera functions using the icons on the screen. Please refer to the tables on the following pages for detailed information about the icons on this screen.



 <p>D-Link Logo</p>  <p>Securicam Logo</p>	<p>Click this logo to visit the D-Link website.</p>
 <p>Client Settings</p>	<p>Setup the stream transmission mode and saving options on the local computer.</p>
 <p>Setup</p>	<p>Click on the setup icon on the main page to enter the camera setting pages. Note that only Administrators can access the setup page. To simplify the setting procedure, two types of user interfaces are available: Advanced Setup for professional users and Standard Setup for entry-level users.</p>
 <p>Digital Output</p>	<p>Click this button to turn the digital output device on or off.</p>
 <p>Video Stream</p>	<p>This camera supports multiple streams (stream 1 to 4) simultaneously. You may select one for live viewing.</p>





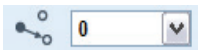
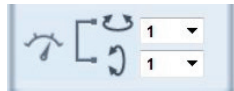

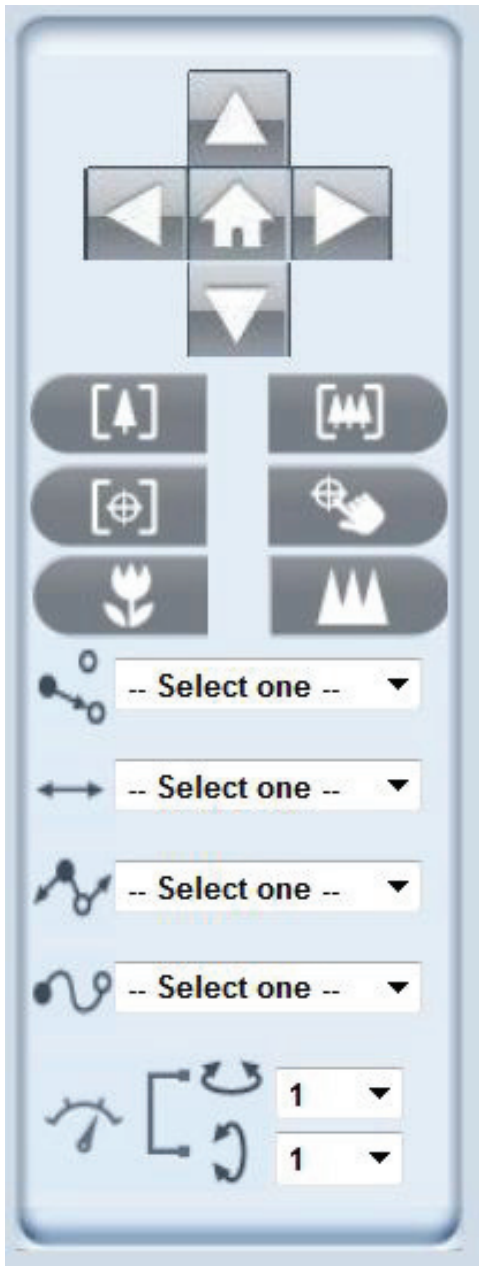



PTZ Control Panel

 <p>Pan Tilt Direction</p>	<p>Home: Move the camera to the preset home position. Direction: Control the camera's pan or tilt directions (up/down/left/right).</p>
 <p>Zoom</p>	<p>Zoom in/out to magnify or shrink the digital image. Zoom In: Magnify image. Zoom Out: Diminish image. Auto Focus: Set the camera to automatically determine correct focus. Manual Focus: The user determines the focal area. Focus Near: Sets the depth of field zone as close. Focus Far: Sets the depth of field zone as far.</p>
 <p>Patrol Auto Pan</p>	<p>Patrol: Patrol executes a pre-defined sequence of pan, tilt, zoom, and focus features. Before selecting this, users must define at least two preset points. Auto Pan: Auto Pan automatically scans an area horizontally. Cruise: Select from up to 8 user defined cruise paths.</p>
 <p>Go Preset</p>	<p>Select from the preset drop-down list to quickly move the camera to the desired preset position.</p>
 <p>Speed Control</p>	<p>Control Pan/Tilt Pan Speed Control Tilt Speed Control</p>



Camera Control

 Snapshot	<p>Click this button to capture and save still images. The captured images will be displayed in a pop-up window. Right-click the image and choose Save Picture As to save it in JPEG (*.jpg) or BMP (*.bmp) format.</p>
 Recording	<p>Click this button to record video clips to your computer. When you exit the web browser, video recording stops accordingly.</p>
 Recording Folder	<p>Specify a storage destination for the recorded video files.</p>
 Microphone Level	<p>Microphone Level: When the mute function is not active, move the slider bar to adjust the level of the microphone (internal/external) that is connected to your network camera.</p>
 Microphone Mute	<p>Microphone Mute/Un-mute: Click to turn off the microphone (internal/external) that is connected to your network camera. Press again to turn the microphone back on.</p>
 Speaker Volume	<p>Speaker Volume - When the mute function is not active, move the slider bar to adjust the volume of the speakers that are connected to your network camera.</p>
 Speaker Mute	<p>Speaker Mute/Un-mute: Click to mute the external speaker that is connected to the network camera. Press again to un-mute the speaker.</p>
 Full Screen	<p>Click this button to switch to full screen mode. Press the "Esc" key to switch back to normal mode.</p>
 Zoom ratio	<p>Auto: The video zoom ratio will be changed automatically according to viewing window size. 100%: Keep the video zoom ratio at 100% 50%: Keep the video zoom ratio at 50% 25%: Keep the video zoom ratio at 25%</p>

Client Settings

Clicking the Client Settings button  will bring you to the following screen which allows you to configure the basic protocol options for your camera.

H.264 Media Options

Video and Audio can be viewed at the same time or separately.

H.264 Protocol Options

For additional information about streaming options please see page 41.

UDP Unicast: Stream to a single computer.

UDP Multicast: Stream to multiple computers using multicast streaming.

TCP: Provides higher quality video streaming than UDP and provides error correction. However, transmission speed will be reduced.

HTTP: Offers the highest image and video quality. However, packet loss will diminish image quality when bandwidth becomes restricted. If the network is protected by a firewall and it opens only HTTP port (80), HTTP protocol must be selected. In this mode, audio is disabled and only video can be viewed. UDP connections will not be available to remote users if all four ports have not been forwarded "Port and Access Name Settings" on page 38. Only the HTTP port must be forwarded for remote users to make an HTTP connection (video only).

Saving Options

Folder: Select the folder where you would like the file saved on your desktop computer.

File name prefix: Enter a file name prefix for the saved files.

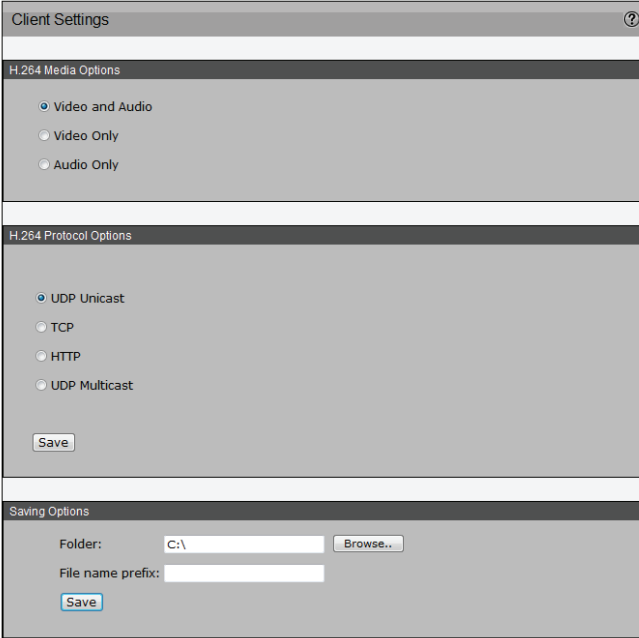

Client Settings

H.264 Media Options

- Video and Audio
- Video Only
- Audio Only

H.264 Protocol Options

- UDP Unicast
- TCP
- HTTP
- UDP Multicast

Save

Saving Options

Folder: C:\

File name prefix:

Save

Setup

The DCS-6915 includes basic and advanced setup screens. Both screens include a tree view with multiple setup options. This manual includes detailed explanations for all advanced setup screens.

Standard Setup

Click the **setup** button to enter the setup screen.



Click on the **basic** button to enter the setup screen.



Please click the [+] next to each folder to view the options.

Basic setup includes the following options:

System Overview

Audio and Video

- Video Settings, Audio Settings

Network

- IP Settings

Event Management

- Motion Detection

PTZ Control

- Motorized PTZ

System

- User Settings, Device Settings, Time and Date, Maintenance

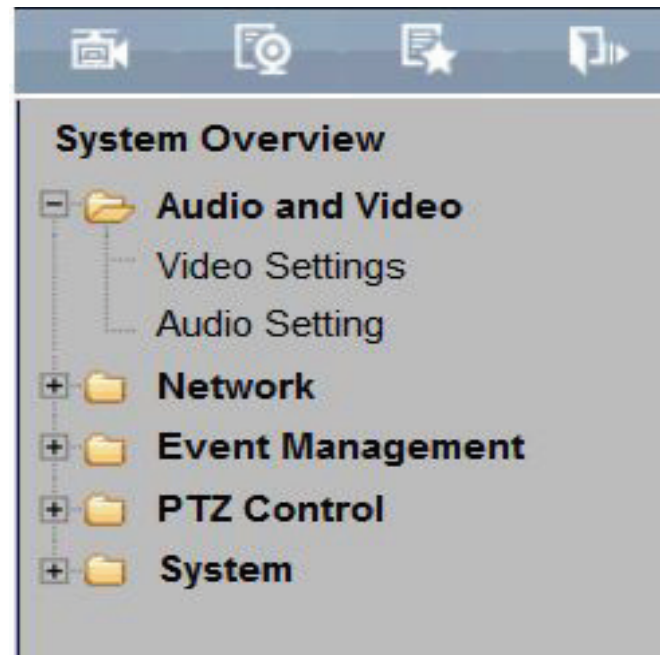

Advanced Setup

Click the **setup** button to enter the setup screen.



Click on the **advanced** button to enter the setup screen.



Please click the [+] next to each folder to view the options.

Advanced setup includes the following options:

System Overview

Audio and Video

- Video Settings, Image Settings, Audio Settings, Day and Night Settings

Network

- IP Settings, Port & Access Name Settings, Dynamic DNS, HTTPS, Access List, Advanced Settings

Event Management

- Motion Detection, DI and DO, Event Settings

Recording

- Recording Settings, Local Storage

PTZ Control

- Motorized PTZ

System

- User Settings, Device Settings, Time and Date, Maintenance, Parameter List, Logs

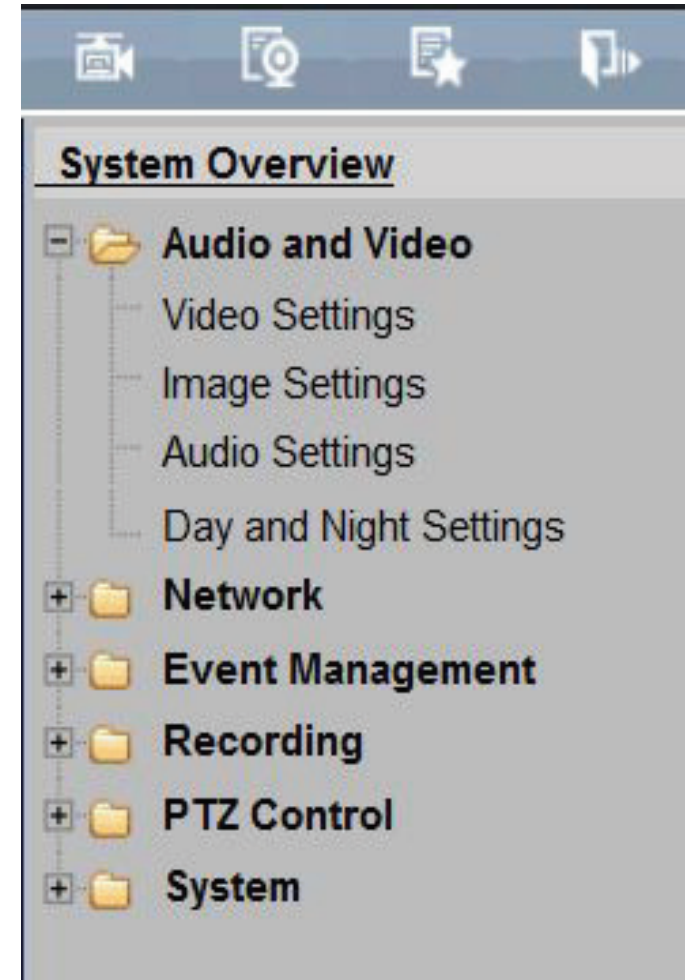

System Overview

The system overview page contains a summary of the camera's current settings. For more information about adjusting these settings, please consult the subsequent instructions found in this manual.

D-Link DCS-6915 SECURICAM

192.168.0.106

System Overview

- Audio and Video
- Network
- Event Management
- Recording
- PTZ Control
- System

System Overview

Device Information

IP address	192.168.0.106
Current firmware version	v1.00.00
Current firmware date	Nov 30 2012
MAC address	28:10:7B:00:03:79

Time and Date

Current system time	2010/7/2 1:45:20
System up time	3 Days, 23:32
Time mode	Manually

Service Status

Service	Enable/Disable	Protocol	Service port
HTTP	Enable	TCP	80
HTTPS	Disable	TCP	443
FTP	Disable	TCP	21
RTSP	Enable	UDP	554
UPnP Presentation	Enable	-	-
UPnP port forwarding	Enable	-	-
802.1x	Disable	-	-
QoS/DSCP	Disable	-	-
SNMP	Disable	-	-
DDNS	Disable	-	-
Access list	Disabled	-	-

Stream Status

Stream number	Codec type	Resolution	Max Frame Rate	Bitrate / Quality
Stream 1	H.264	1920 x 1080	13	Excellent
Stream 2	H.264	1280 x 1024	13	Good
Stream 3	H.264	1280 x 720	13	Good
Stream 4	MPEG	720 x 576	13	35

Recent Logs

```
[Mon Jun 28 02:10:00 2010] --Network interface initialized start
[Mon Jun 28 02:10:07 2010] --Network interface initialized end
[Mon Jun 28 02:10:07 2010] --Host IP = 192.168.0.106
[Mon Jun 28 02:10:07 2010] --Subnet Mask = 255.255.255.0
[Mon Jun 28 02:10:07 2010] --Gateway = 192.168.0.1
[Mon Jun 28 02:10:07 2010] --MAC address = 28:10:7B:00:03:79
[Tue Jun 29 23:59:58 2010] --admin@:ffff:192.168.0.100 GET / HTTP/1.1
[Wed Jun 30 00:00:01 2010] --admin@:ffff:192.168.0.100 GET /cgi-bin/setLogout.cgi HTTP/1.1
[Wed Jun 30 00:00:02 2010] --admin@:ffff:192.168.0.100 GET /cgi-bin/ret.cgi HTTP/1.1
[Wed Jun 30 00:00:02 2010] --admin@:ffff:192.168.0.100 GET /cgi-bin/ret.cgi HTTP/1.1
```

Audio and Video

Video Settings

This page allows you to set up 4 video streams to be displayed on a computer, mobile device, or storage system. Each stream has independent options for proper compression type, frame size, frame rate to optimize the bandwidth utilization and video quality.

Sensor Setting: Click **Sensor Setting** to open the Sensor Setting page. On this page, you can set the maximum exposure time, exposure level, and AGC (Auto Gain Control) setting. You can configure two sets of sensor setting: one for normal situations (Profile 1), the other for special situations, such as day/night/schedule mode.

Enable BLC (Back Light Compensation): Enable this option when the object is too dark or too bright to recognize. It allows the camera to adjust to the best light conditions in any environment and automatically give the necessary light compensation.

Exposure

- **Max Gain:** You can manually set the Max Gain level from off to 57dB. The higher the value, the brighter the image will be.
- **Full Auto:** Allow the camera to adjust exposure time and iris automatically.
- **Slow shutter:** In this mode, it is the shutter speed that takes main control of the exposure. The range of shutter speed is from 1/10000 to 1.
- **Maximum Exposure Time:** Select a proper maximum exposure time according to the light source of the surroundings. Shorter exposure times result in less light reaching the sensor. The exposure times are selectable for the following durations: 1/25 (1/30) to 1/10,000
- **P-Iris:** Choose a P-Iris value from F4.8 to F9.6
- **Iris Priority:** Select from the range of values between F1.6 to F28

Manual Mode

- **Manual:** Select to enable manual settings
- **Maximum Exposure Time:** Select a proper maximum exposure time according to the light source of the surroundings. Shorter exposure times result in less light reaching the sensor. The exposure times are selectable for the following durations: 1/25 (1/30) to 1/10,000
- **Iris:** Choose an Iris value from F4.8 to F9.6
- **Exposure Level:** Select from the range of values between 1 to 15

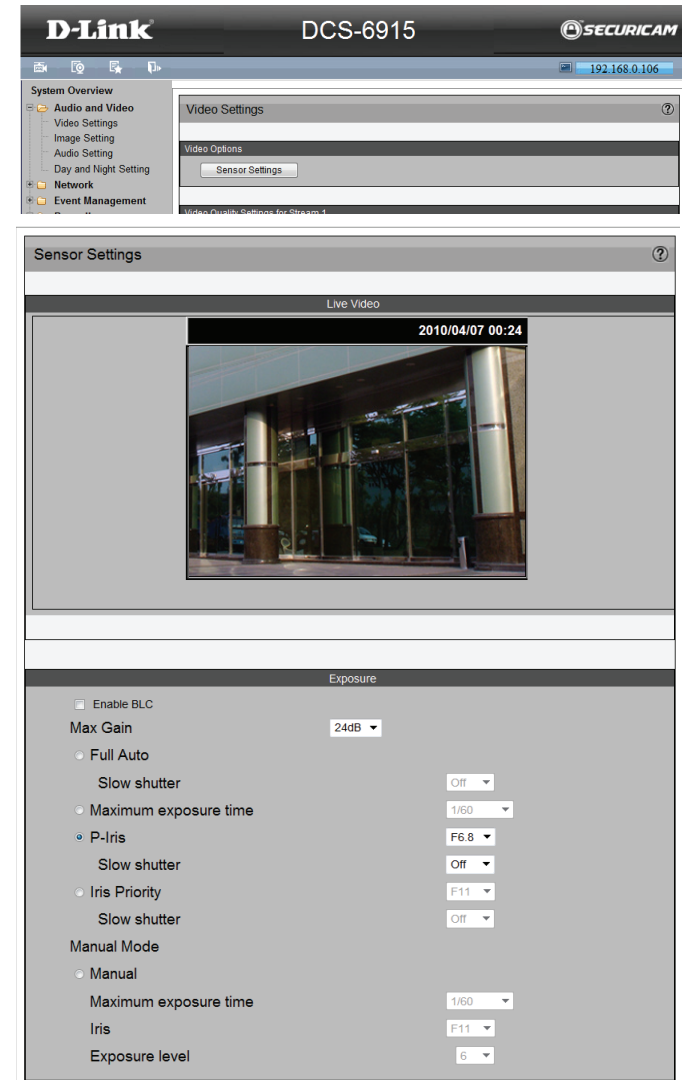

Section 3: Advanced Configuration

Stream 1-3: Users can define the "Region of Interest" (viewing region) and the "Output Frame Rate" (size of the live view window).

Stream 4: This is global view stream which captures the full view of the video. Users can also define the "Output Frame Rate" (size of the live view window).

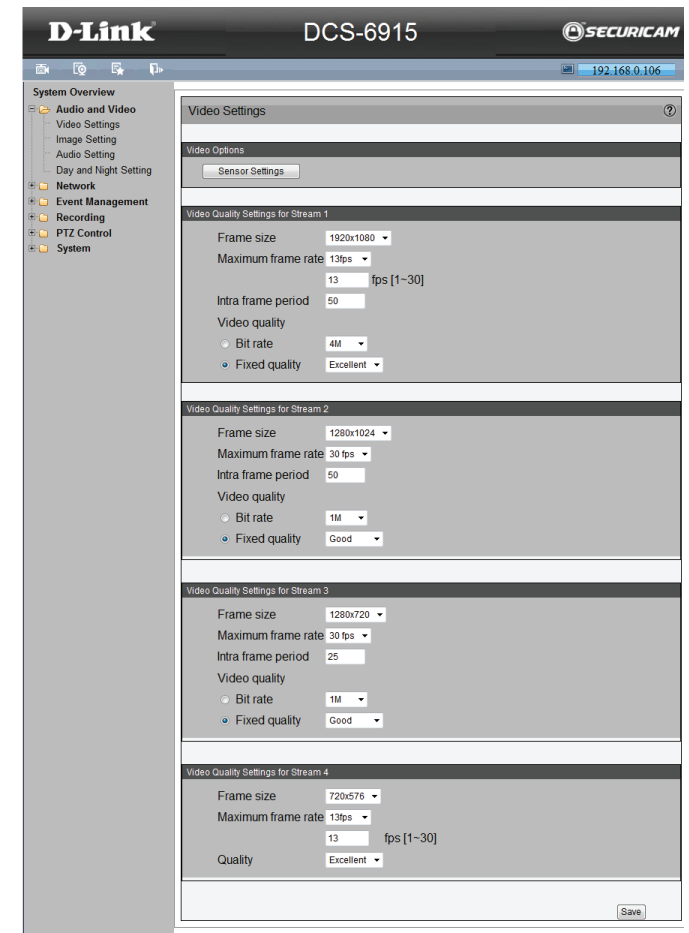

The screenshot displays the D-Link DCS-6915 web interface, specifically the "Video Settings" page. The interface is titled "D-Link DCS-6915" and includes a "SECURICAM" logo. A navigation menu on the left lists "System Overview", "Audio and Video", "Network", "Event Management", "Recording", "PTZ Control", and "System". The "Audio and Video" section is expanded, showing "Video Settings", "Image Setting", "Audio Setting", and "Day and Night Setting". The main content area is titled "Video Settings" and contains a "Sensor Settings" button. Below this, there are four sections for "Video Quality Settings for Stream 1", "Stream 2", "Stream 3", and "Stream 4". Each section includes fields for "Frame size", "Maximum frame rate", "Intra frame period", and "Video quality". The "Video quality" section has radio buttons for "Bit rate" and "Fixed quality".

Stream	Frame size	Maximum frame rate	Intra frame period	Video quality
Stream 1	1920x1080	13fps	50	Fixed quality: Excellent
Stream 2	1280x1024	30fps	50	Fixed quality: Good
Stream 3	1280x720	30fps	25	Fixed quality: Good
Stream 4	720x576	13fps	13	Quality: Excellent

Video Quality Setting for Stream 1 - 4

Compression Type: The compression level affects the amount of bandwidth and storage required. Lower compression uses more bandwidth and storage but delivers better image quality. Of the three options, H.264 consumes much less network bandwidth compared to MPEG4 and JPEG.

Frame Size: Select proper frame size for different viewing devices, bigger frame size requires more bandwidth and storage usage. For smaller viewers, such as mobile phones, a smaller frame size and lower frame rate is recommended. There are 8 options you can select: 352x240, 640x480, 720x480, 800x600, 1024x768, 1280x720, 1280x1024, 1920x1080.

Maximum Frame Rate: This option affects the smoothness of the video. Select higher frame rate for smoother video quality but it requires more storage usage. 3 options for selection: customize, 15 fps, 30fps.)

Intra Frame Period: Determine how often to plant an I frame The shorter the duration, the more likely you will get better video quality, but at the cost of higher network bandwidth consumption Select the intra frame period from the following durations: 1/4 second, 1/2 second, 1 second, 2 seconds, 3 seconds, and 4 seconds

Video Quality: This setting limits the maximum refresh frame rate.

- **Constant bit rate:** To set a fixed bandwidth regardless of the video quality, select Bit rate and the desired bandwidth from 20 Kbps to 8 Mbps. You can also select **Customize** and manually enter a value.
- **Fixed quality:** To optimize the bandwidth utilization and video quality. The video quality can be adjusted to the following setting: Medium, Standard, Good, Detailed and Excellent. You can also select **Customize** and manually enter a value.

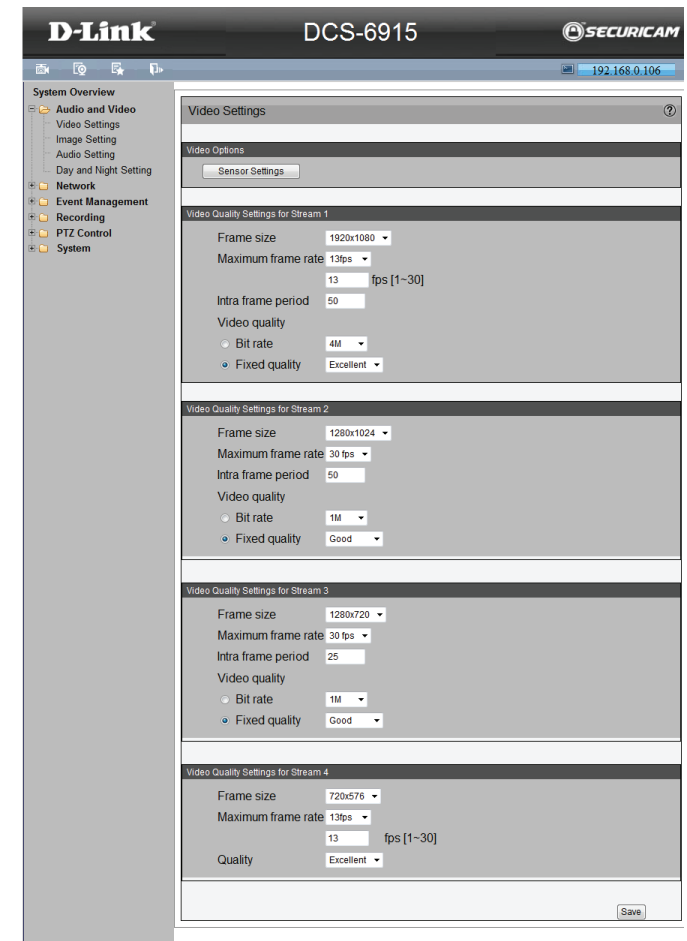

Image Settings

This page allows you to tune the white balance, brightness, saturation, contrast, and sharpness settings for the video.

Color: Select either a Color or B/W (black and white, monochrome) video display.

Power Line Frequency: Select either 50 or 60 Hz depending on your region.

Flip: Flip: Users can track an object continuously when it passes through under the dome camera with setting flip to mechanical mode (M.E.) or digital flip mode (Image).

- **M.E. mode:** M.E. mode is a standard mechanical operation. As the Dome Camera tilts to the maximum angle, it will pan 180°, and then continue tilting to keep tracking objects.
- **Image mode:** Image mode represents digital image flip, which enables user to keep tracking objects seamlessly; under the mode, almost no delay occurs in comparing with that under the M.E. mode.

Note: The tilt range of flip can be set in “PTZ Control/Tilt Range setting”, the angle is from -10° to +100°.

White Balance: This adjusts the relative amount of red, green and blue primary colors in the image so that the neutral colors are reproduced correctly.

- **Auto:** The camera automatically adjusts the color temperature of the light in response to different light sources. The white balance setting defaults to Auto and works well in most situations.
- **Indoor/Outdoor Mode:** Camera will adjust white balance automatically based on indoor/Outdoor default parameter.
- **ATW mode:** The Dome Camera takes out the signals in a screen in the range from 2500 K to 10000 K.
- **Manual mode:** In this mode, users can change the White Balance value manually via specifying R gain and B gain; the range of R/B gain is from 0 to 255.

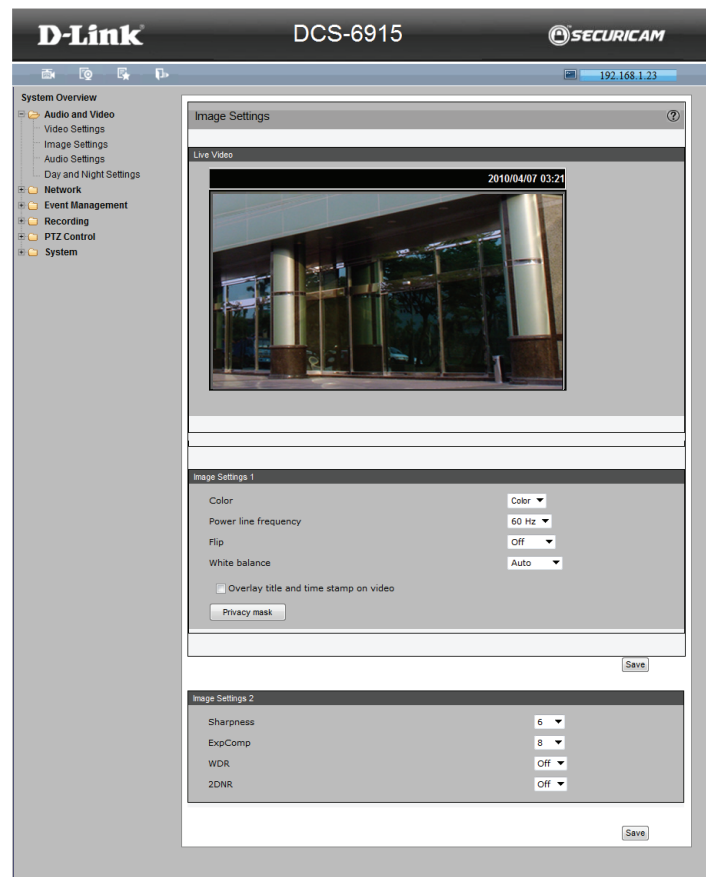

Section 3: Advanced Configuration

1. Set the White balance to Auto and click **Save**.
2. Place a sheet of white paper in front of the lens, then allow the camera to adjust the color temperature automatically.
3. Select Fixed to confirm the setting while the white balance is being measured.
4. Click **Save** to enable the new setting.

Overlay Title and Time Stamp on Video: Select this option to place the video title and time on the video streams. (When the frame size is set to 176 x 144 only the time will be stamped on the video streams.)

Sharpness: Increasing the sharpness level can make the image look sharper; especially enhancing the object's edge. The Sharpness value is adjustable from 1 to 15.

ExpComp: Users can define the value of Exposure Compensation; the value ranges from 1 to 15.

WDR: The WDR function is especially effective in environment with extreme contrast.

2DNR: With the 2D Noise Reduction function, the processor analyzes pixel by pixel and frame by frame to eliminate environmental noise signals so that the highest quality image can be produced even in low light conditions.

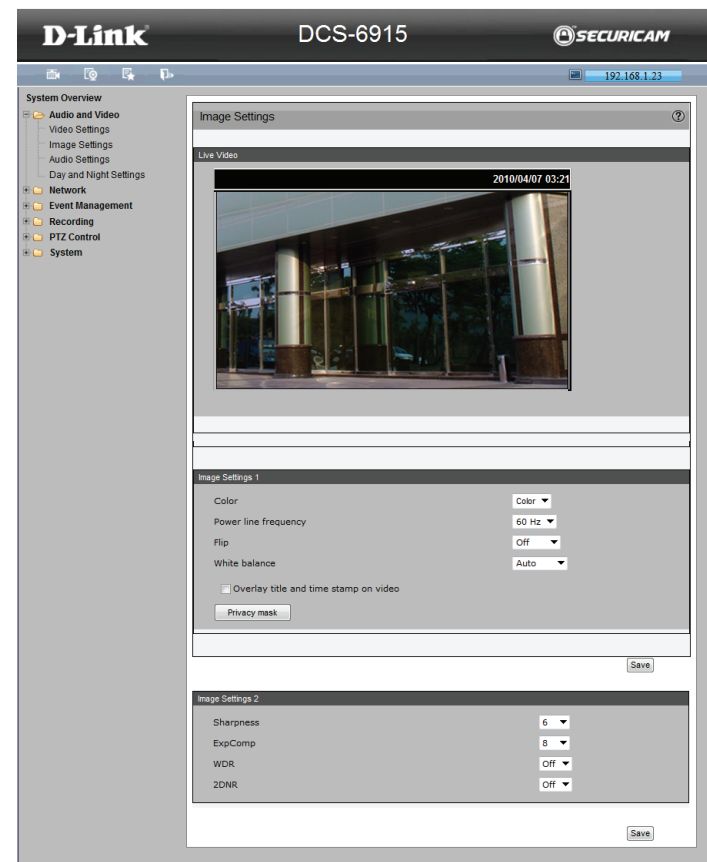

Privacy Mask: In this page, you can block out certain sensitive zones for privacy concerns.

Mask Setting

Switch: Choose On or Off to enable/disable privacy mask.

Transparency: Choose On to let the mask be transparent.

Color: Black/White/Red/Green Blue/Cyan/Yellow/Magenta are available colors for the mask.

Mask [1-16]: Upto 16 masks can be set.

Hsize [1 - 80]: The horizontal length of the mask. The mask center is at the center of current live view. User may adjust Hsize or zoom in/out to set the ideal mask length.

Vsize [1 - 60]: The vertical height of the mask. The mask center is at the center of current live view. User may adjust Vsize or zoom in/out to set the ideal mask height.

Mask clearing

Choose the number of the mask and click **Clear** button to delete the mask.

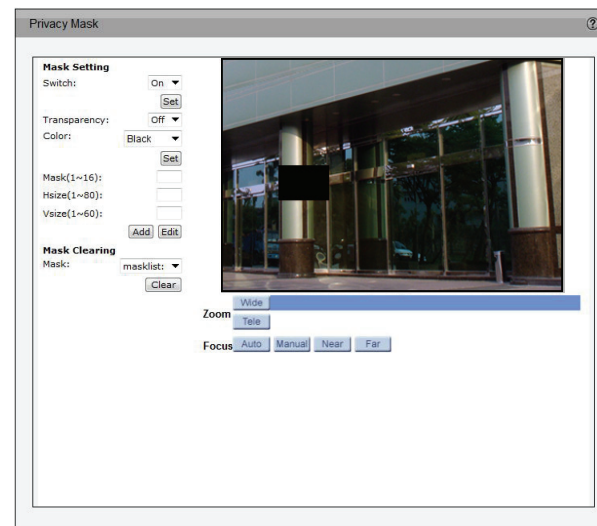

Audio Settings

Mute: Select to mute audio.

Note:

- If the switch on the Control board is switched off (disabled audio) then this option will be disabled.

External microphone input: Sets microphone input gain between 1 and 6.

Note: The higher the setting, the louder the sound.

Output Gain: Set the audio input/output gain levels for sound amplification. The audio gain values are adjustable from 1 to 6. The sound will be turned off if the audio gain is set to “Mute”.

Audio Type: Select between uLAW (G.711) and ALAW (G.711) compression formats. A higher audio quality will require more bandwidth.

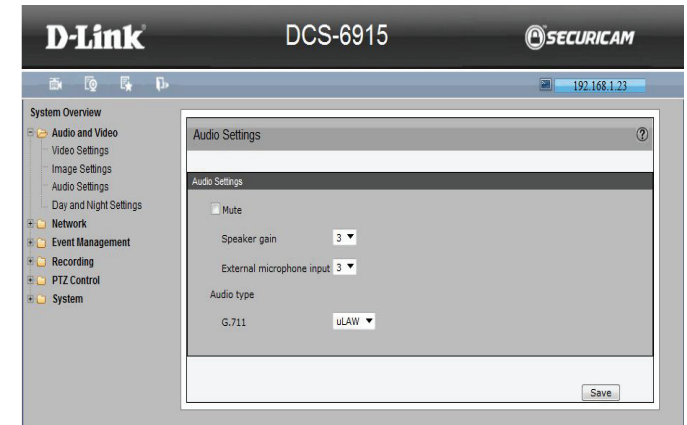

Day and Night Settings

IR Cut Filter: The IR-Cut Removable (ICR) filter mechanically switches between two different sensor filters. It provides the best light conditions both during the day and night. The following options are:

- **Auto Mode:** The camera automatically switches between day and night mode by judging the level of ambient light. This mode is accessible only when the exposure mode is set to Auto.
- **Day Mode:** In this mode the camera switches on the IR cut filter at all times, which will block the infrared light from reaching the sensor so that the colors are not distorted.
- **Night Mode:** The camera switches off the IR cut filter to allow the infrared light to pass through. This helps the camera to see more clearly in low light conditions.
- **Schedule Mode:** The camera switches between day and night mode based on a specific schedule. Ensure to enter the starting and ending time for the day mode. Note that the time format is [hh:mm] and is expressed in 24-hour clock time.

Light Sensor Sensitivity: Select Low, Normal, or High sensitivity for the light sensor.

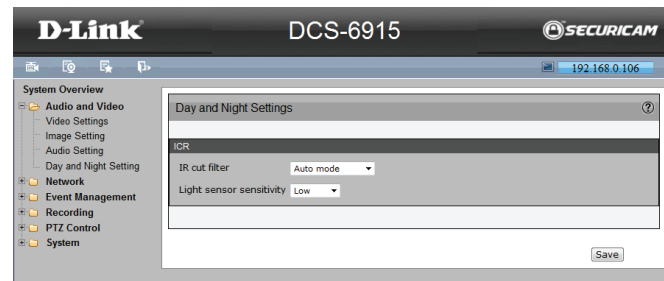

Network IP Settings

LAN

Get IP address automatically (DHCP): The camera's default setting is . Please refer to User's Manual for login with the default IP address. If select , after the IP Camera restarts, users can search it through the installer program: DeviceSearch.exe, which can be found in "DeviceSearch" folder in the supplied CD. NOTE: Please make the record of the IP Camera's MAC address, which can be found in the label of the camera, for identification in the future.

Note: The camera will switch to static IP after 60 seconds if an IP address is not assigned

Use fixed IP address: To setup a static IP address, select and move the cursor to the IP address field and insert the new IP address, ex. 192.168.7.123; then go to the Default gateway (explained later) and change the setting, eg. 192.168.7.254.

IP address: This is necessary for network identification.

Subnet mask: It is used to determine if the destination is in the same subnet. The default value is "255.255.255.0".

Default gateway: This is the gateway used to forward frames to destinations from a different subnet. An invalid gateway setting will fail to transmit to destinations in a different subnet.

Primary DNS: The Primary DNS is the primary domain name server that translates hostnames into IP addresses.

Secondary DNS: The Secondary DNS is a secondary domain name server that backups the primary DNS.

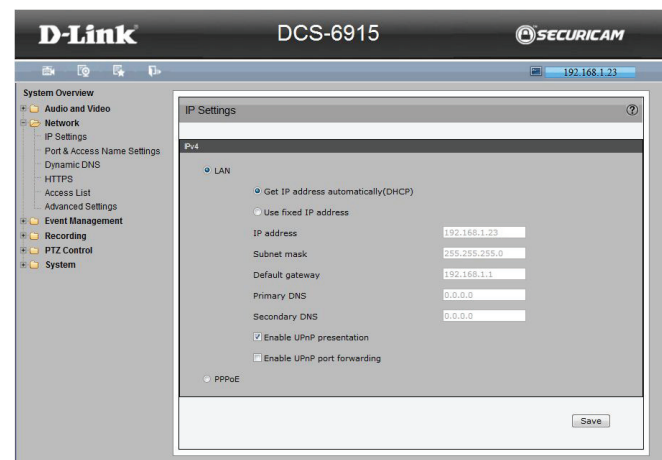

Enable UPnP Presentation

Enabling this setting allows your camera to be configured as a UPnP device on your network.

Enable UPnP Port Forwarding

Enabling this setting allows the camera to add port forwarding entries into the router automatically on a UPnP capable network.

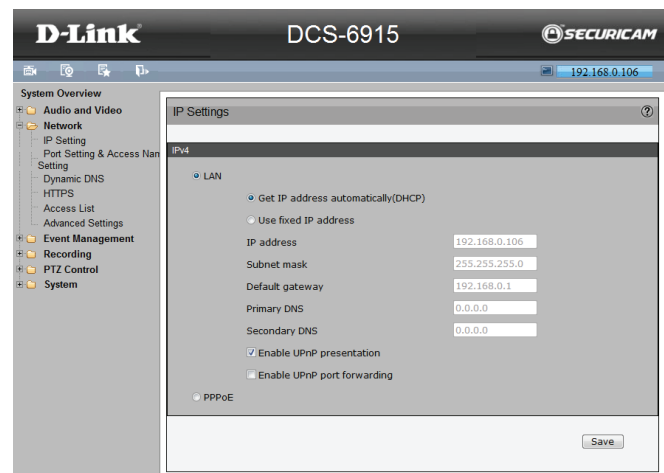

PPPoE

For PPPoE users, enter the PPPoE Username, Password and Confirm Password into the fields, and click on the **Save** button to complete the setting.

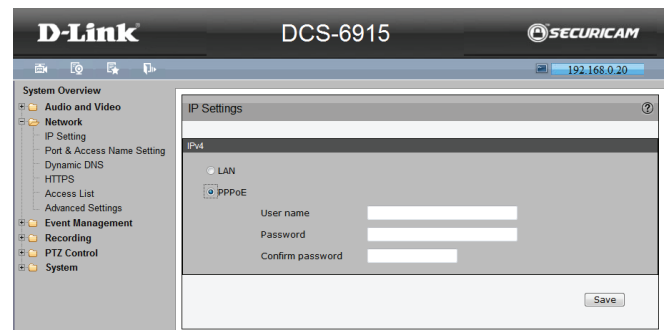

Port and Access Name Settings

HTTPS

By default, the HTTPS port is set to 443. It can also be assigned to another port number between 1025 and 65535.

To use HTTPS on the Network Camera, a HTTPS certificate must be installed. The HTTPS certificate can be obtained by either creating and sending a certificate request to a Certificate Authority (CA) or creating a self-signed HTTPS certificate, as described below.

HTTP: The default web server port is 80. If the port is changed, the client must be notified of the change for the connection to be successful. For instance, if the Administrator changes the HTTP port of the Network Camera whose IP address is 192.168.0.100 from 80 to 8080, the user must type in the web browser “http://192.168.0.100:8080” instead of “http://192.168.0.100”.

Access name for stream 1, 4: This Network Camera supports multiple streams simultaneously. The access name is used to differentiate the streaming source.

RTSP

Authentication: Depending on your network security requirements, the Network Camera provides three types of security settings for streaming via RTSP protocol: disable, basic, and digest. If basic authentication is selected, the password is sent in plain text format, but there can be potential risks of it being intercepted. If digest authentication is selected, user credentials are encrypted using MD5 algorithm, thus providing better protection against unauthorized access.

Access name for stream 1 to 4: This Network Camera supports multiple streams simultaneously. The access name is used to differentiate the streaming source.

Note: Ensure to choose the different port from the one set for the web server port.

FTP

The FTP server allows the user to save recorded video clips. You can utilize D-Link's IP Cam Wizard to upgrade the firmware via FTP server. By default, the FTP port is set to 21. It also can be assigned to another port number between 1025 and 65535.

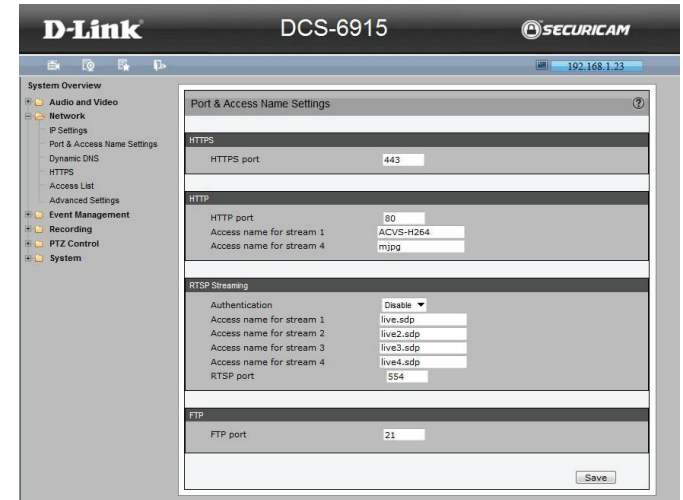

Dynamic DNS

This section explains how to configure the dynamic domain name service for the camera. DDNS is a service that allows your camera, especially when assigned with a dynamic IP address, to have a fixed host and domain name.

Enable DDNS: Select this option to enable the DDNS setting.

Server Name: Select a DDNS server name from the provider drop-down list. With a Dynamic DNS account, the camera automatically updates your IP address. To enable DDNS, enter your host information. Click **Save** to continue.

Host Name: Enter the host name of the DDNS server.

Username: Enter your username or e-mail used to connect to the DDNS

Password: Enter your password used to connect to the DDNS server.

Confirm password: Re-enter the password to confirm

Status: Indicates the connection status, automatically determined by the system.

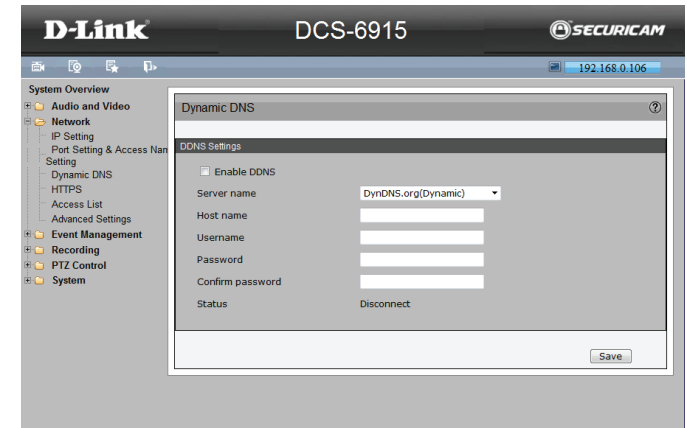

HTTPS

This section explains how to enable authentication and encrypted communication over SSL (Secure Socket Layer). It helps protect streaming data transmission over the Internet on higher security level.

Enable HTTPS

Select this item to enable HTTPS communication, then select a connection option: "HTTP & HTTPS" or "HTTPS only".

Note: You must create and install a certificate first in the "Create and Install Certificate Method" section before clicking the **Save** button.

Create and Install Certificate Method

Before using HTTPS for communication with the camera, a certificate must be created first.

There are three ways to create and install a certificate:

Create Self-signed Certificate Automatically

1. Select this option.
2. In the first column, select **Enable HTTPS secure connection**, then select a connection option: "HTTP & HTTPS" or "HTTPS only".
3. Click **Save** to generate a certificate.
4. The **Certificate Information** will automatically be displayed in the third column. You can click **Property** to view detailed information about the certificate.
5. Click **Live Video** to return to the main page. Change the address from "http://" to "https://" in the address bar and press Enter. Some Security Alert dialogs will pop up. Click **OK** or **Yes** to enable HTTPS.

Create Self-signed Certificate Manually

1. Click **Create** to open the Create Certificate page, then click **Save** to generate the certificate.
2. The Certificate Information will automatically be displayed in the third column as shown below. You can click **Property** to see detailed information about the certificate.

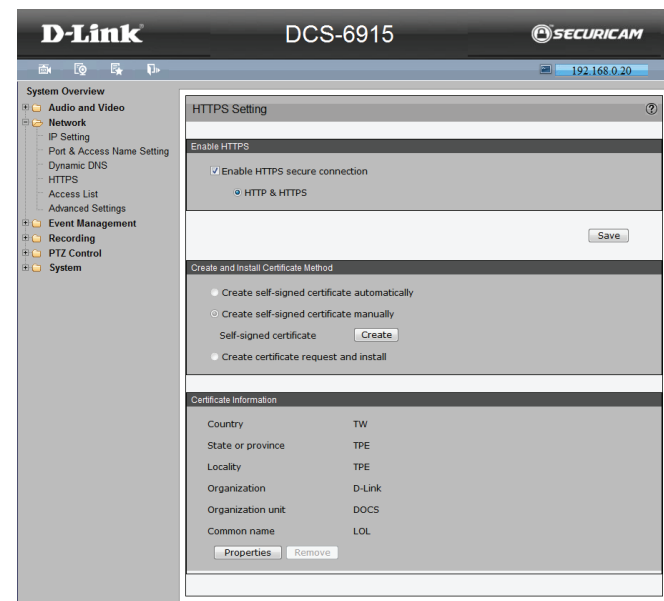

Create Certificate Request and Install

Select this option to create a certificate from a certificate authority.

1. Click **Create** to open the **Create Certificate** page, then click **Save** to generate the certificate.
2. If you see the information bar, click **OK** and click on the Information bar at the top of the page to allow pop-up.
3. The pop-up window shows an example of a certificate request.
4. Look for a trusted certificate authority that issues digital certificates. Enroll the camera.

Wait for the certificate authority to issue a SSL certificate. Click **Browse...** to search for the issued certificate, then click **Upload** in the "Create and Install Certificate Method" section.

How to disable the HTTPS setting?

1. Deselect **Enable HTTPS secure connection** in the first column and click **Save**. A warning dialog will pop up.
2. Click **OK** to disable HTTPS.
3. The webpage will redirect to a non-HTTPS page automatically.

If you want to create and install other certificates, please remove the existing one. To remove the signed certificate, deselect Enable HTTPS secure connection in the first column and click **Save**. Then click **Remove** to erase the certificate.

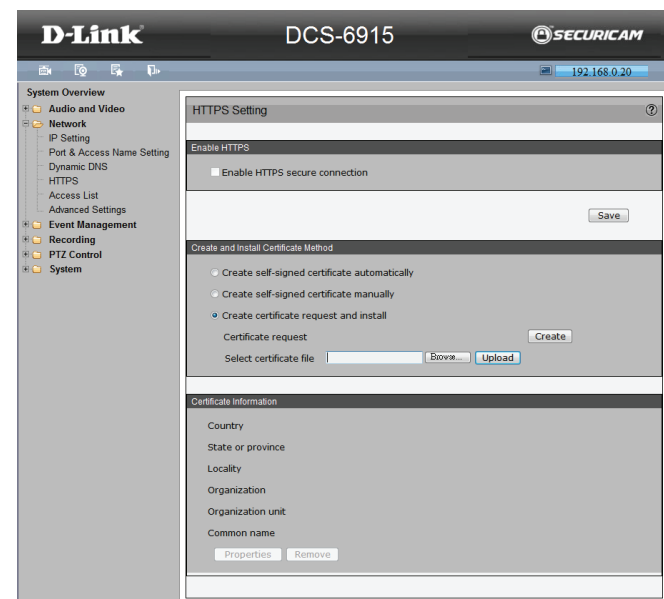

Access List

This section explains how to control access permissions by verifying the connecting client PC's IP address.

Enable access list filtering: Access to the IP Camera can be restricted by denying/allowing specific IP addresses. Check the box to enable the IP Filter function. Once enabled, the listed IP addresses (IPv4) will be allowed/denied access to the IP Camera.

Filter Type: Select **(Allow)** or **(Deny)** from the drop-down list and click on the button to determine the IP Filter behavior.

Filter: Input the IP address and click on the button to add a new filtered address. The Filtered IP Addresses list box shows the currently configured IP addresses. Up to 256 IP address entries may be specified.

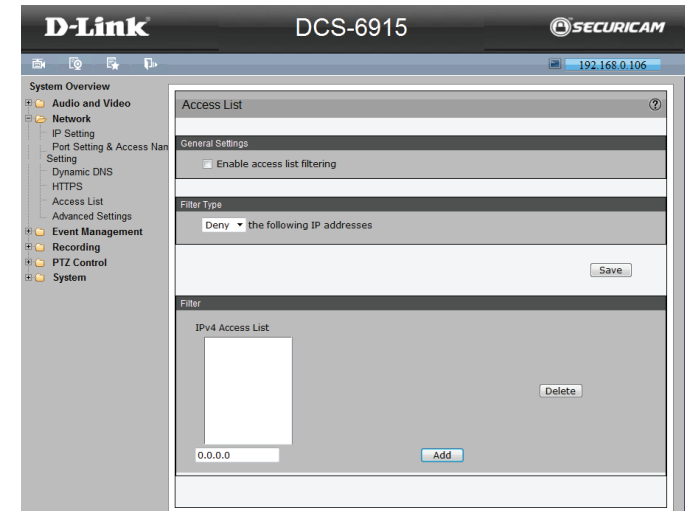

Advanced Settings

SNMP

With Simple Network Management Protocol (SNMP) support, the IP Camera can be monitored and managed remotely by the network management system.

Enable SNMP v1/ v2: Select the version of SNMP to use by checking the box.

Read Community: Specify the community name that has read-only access to all supported SNMP objects. The default value is “public”.

Write Community: Specify the community name that has read/write access to all supported SNMP objects (except read-only objects). The default value is “write”.

IEEE 802.1X: The IP Camera is allowed to access a network protected by 802.1X/ EAPOL (Extensible Authentication Protocol over LAN). Users need to contact with the network administrator for gaining certificates, user IDs and passwords.

CA Certificate: The CA certificate is created by the Certification Authority for the purpose of validating itself. Upload the certificate for checking the server’s identity. Client Certificate/ Private Key Upload the Client Certificate and Private Key for authenticating the IP Camera itself.

Identity: Enter the user identity associated with the certificate. Up to 16 characters can be used.

Private Key Password: Enter the password (maximum 16 characters) for your user identity.

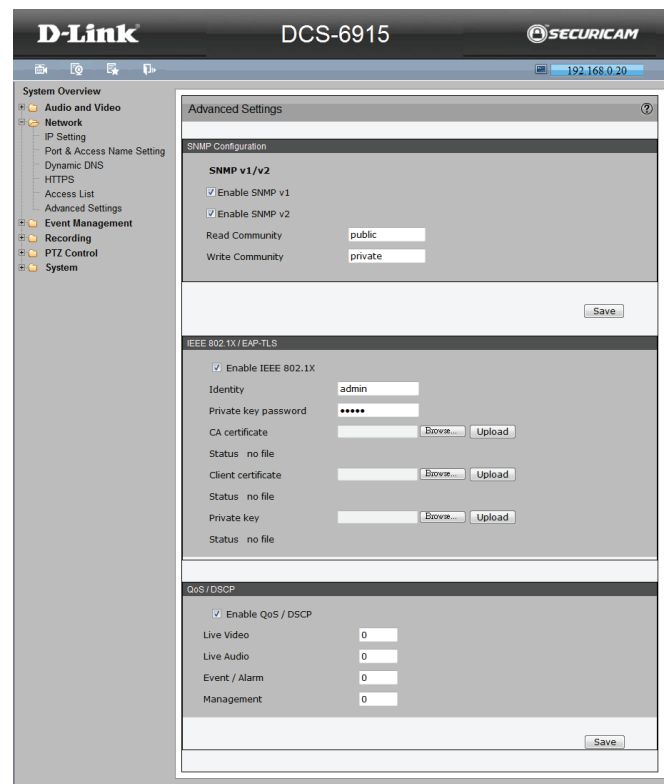

QoS: QoS allows providing differentiated service levels for different types of traffic packets, which guarantees delivery of priority services especially when network congestion occurs. Adapting the Differentiated Services (DiffServ) model, traffic flows are classified and marked with DSCP (DiffServ Codepoint) values, and thus receive the corresponding forwarding treatment from DiffServ capable routers.

DSCP Settings: The DSCP value range is from 0 to 63. The default DSCP value is 0, which means DSCP is disabled. The IP Camera uses the following QoS Classes: Video, Audio and Management.

Live Video: The class consists of applications such as MJPEG over HTTP, RTP/RTSP and RTSP/HTTP.

Live Audio: This setting is only available for the IP Cameras that support audio.

Management: The class consists of HTTP traffic: Web browsing.

Note: To enable this function, please make sure the switches/ routers in the network support QoS.

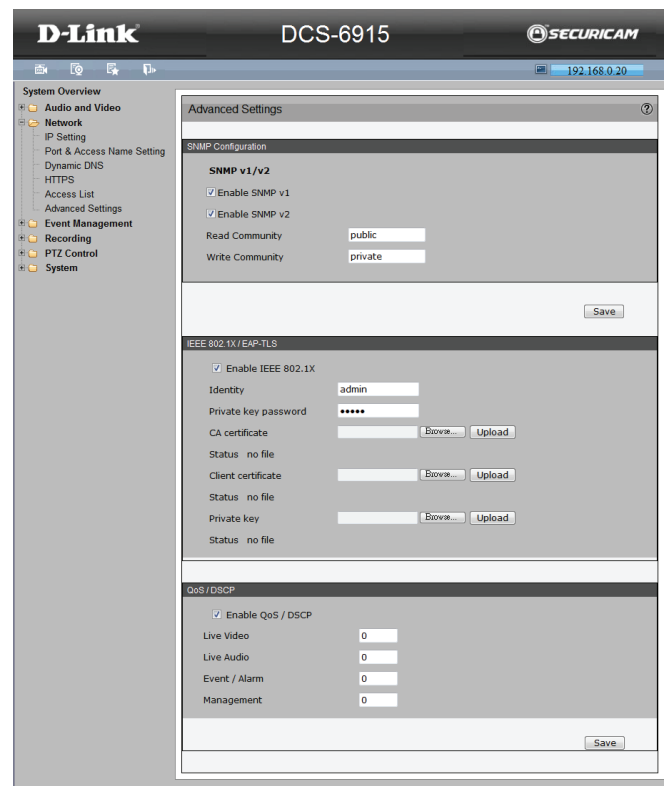

Event Management Motion Detection

Motion can be detected by measuring change in speed or vector of an object or objects in the field of view.

Enable Motion Detection: Select this option to turn on the motion detection feature.

Sensitivity: Set the measurable difference between two sequential images that would indicate motion.

Detection Level: Set the amount of motion in the window being monitored that is required to trigger a motion detected alert. If this is set to 100, this means that motion must be detected within the whole window to trigger a snapshot.

Note: Setting a higher sensitivity and a lower detection level will make motion more easily detected.

Add: Click to add a new window. A maximum of three motion windows can be opened simultaneously. Use your mouse to drag the window frame to resize or the title bar to move. Clicking on the 'x' at the upper right corner of the window will close the window.

Save: Save the configured settings.

To enable motion detection, follow the steps below:

1. Click **Add** to add a new motion detection window.
2. Define the sensitivity to moving objects and the space ratio of all alerted pixels by moving the Sensitivity and Percentage slide bar.
3. Click **Save** to apply the changes.
4. Select Enable motion detection to activate motion detection.

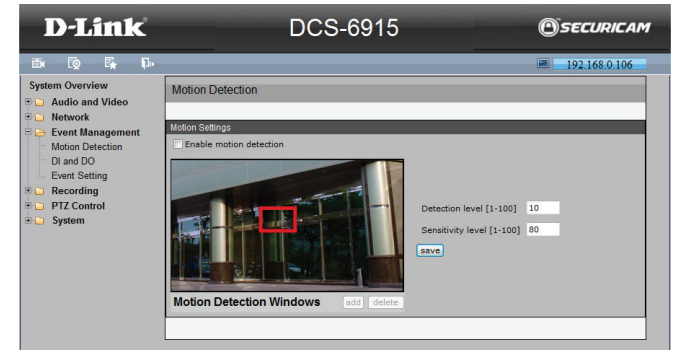

DI and DO

This screen allows you to control the behavior of digital input and digital output devices. The I/O connector provides the physical interface for digital output (DO) and digital input (DI) that is used for connecting a variety of external alarm devices such as IR-Sensors and alarm relays. The digital input is used for connecting external alarm devices and once triggered images will be taken and e-mailed. After making any changes, click the **Save Settings** button to save your changes.

The Network camera supports 4 digital alarm inputs and 2 digital alarm outputs.

Note: Please make sure the alarm connections are properly wired before starting to configure alarm related settings on this page.

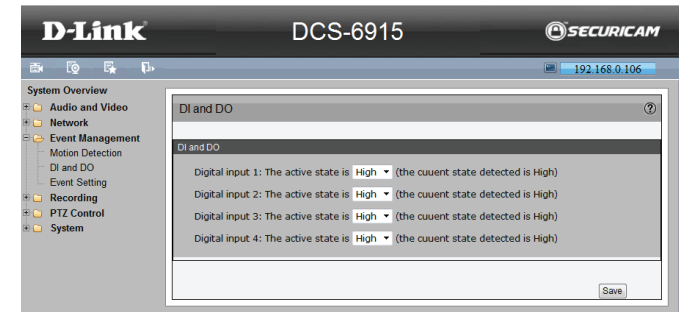

Event Settings

This section explains how to configure the camera to respond to particular situations (an event). A typical application is that when a motion is detected, the camera sends buffered images to an FTP server or e-mail address as notifications.

Server Settings

Click **Add Server** on the Event Settings page to open the Server Setting page. On this page, you can specify where the notification messages are sent when a trigger is activated. A total of 5 server settings can be configured.

Server name: Enter a name for the server setting.

- **Server Type:** There are four choices of server types available: E-mail, FTP, HTTP, and Network storage. Select the item to display the detailed configuration options. You can configure either one or all of them.

E-mail: Select to send the media files via e-mail when a trigger is activated.

- **Sender e-mail address:** Enter the e-mail address of the sender.
- **Recipient e-mail address:** Enter the e-mail address of the recipient.
- **Server address:** Enter the domain name or IP address of the e-mail server.
- **User name:** Enter the user name of the e-mail account if necessary.
- **Password:** Enter the password of the e-mail account if necessary.
- **Server port:** The default mail server port is set to 25. You can also manually set another port.

If your SMTP server requires a secure connection (SSL), select **This server requires a secure connection (SSL)**.

To verify if the e-mail settings are correctly configured, click **Test**. The result will be shown in a pop-up window. If successful, you will also receive an e-mail indicating the result.

Click **Save** to enable the settings, then click **Close** to exit the page.

FTP: Select to send the media files to an FTP server when a trigger is activated.

- **Server address:** Enter the domain name or IP address of the FTP server.
- **Server port:** By default, the FTP server port is set to 21. It can also be assigned to another port number between 1025 and 65535.

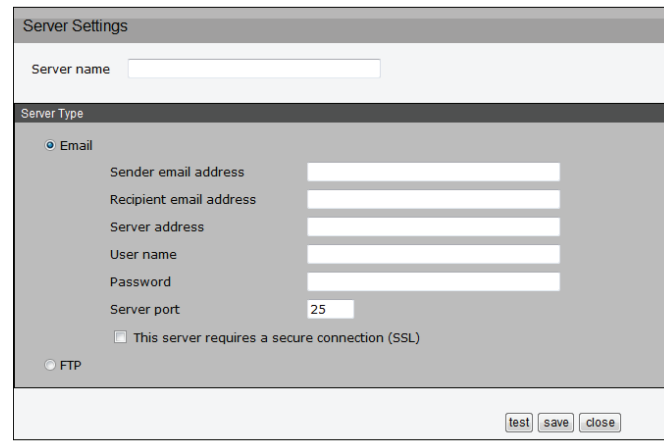
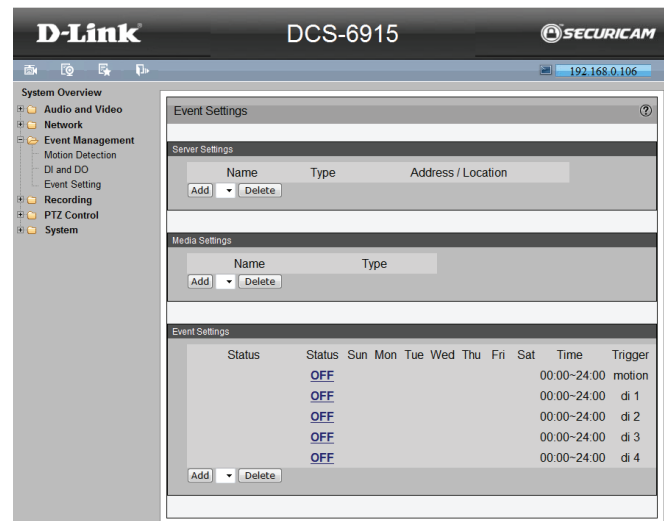

Section 3: Advanced Configuration

- **User name:** Enter the login name of the FTP account.
- **Password:** Enter the password of the FTP account.
- **FTP folder name:** Enter the folder where the media file will be placed. If the folder name does not exist, the camera will create one on the FTP server.
- **Passive mode:** Most firewalls do not accept new connections initiated from external requests. If the FTP server supports passive mode, select this option to enable passive mode FTP and allow data transmission to pass through the firewall.

To verify if the FTP settings are correctly configured, click **Test**. The result will be shown in a pop-up window as shown below. If successful, you will also receive a test.txt file on the FTP server.

Click **Save** to enable the settings, then click **Close** to exit the page.

Media Settings

Click **Add Media** to open the Media Settings page. On this page, you can specify the type of media that will be sent when a trigger is activated. A total of 5 media settings can be configured.

Media name: Enter a name for the media setting.

Media Type: There are three choices of media types available: Snapshot, Video Clip, and System log. Select the item to display the detailed configuration options. You can configure either one or all of them.

Snapshot: Select to send snapshots when a trigger is activated.

Send pre-event images: The camera has a buffer area. It temporarily holds data up to a certain limit. Enter a number to decide how many images to capture before a trigger is activated. Up to 7 snapshots can be generated.

File name prefix: Enter the text that will be appended to the front of the file name.

Add Sequence number suffix: Enter the text that will be appended to the end of the file name.

Click **Save** to enable the settings, then click **Close** to exit the page.

The screenshot shows the 'Server Settings' configuration page. It has a 'Server name' text input field at the top. Below that is the 'Server Type' section with two radio buttons: 'Email' and 'FTP'. The 'FTP' option is selected. Under 'FTP', there are several fields: 'Server address' (text input), 'Server port' (text input with '21' entered), 'User name' (text input), 'Password' (text input), and 'FTP folder name' (text input). There is also a 'passive mode' checkbox which is currently unchecked. At the bottom right of the form are three buttons: 'test', 'save', and 'close'.

The screenshot shows the 'Media Settings' table. It has a header with 'Name' and 'Type' columns. Below the header is a table with one row. To the left of the table are two buttons: 'Add' and 'Delete'.

The screenshot shows the 'Media Settings' configuration page for the 'Snapshot' media type. It has a 'Media name' text input field at the top. Below that is the 'Media Type' section with three radio buttons: 'Snapshot', 'Video clip', and 'System log'. The 'Snapshot' option is selected. Under 'Snapshot', there are two 'Send' fields, each with a text input and a range '[0~7]'. The first is labeled 'pre-event image(s)' and the second is labeled 'post-event image(s)'. Below these is a 'File name prefix' text input field. There are two radio buttons for file naming: 'Add date and time suffix to file name' (selected) and 'Add sequence number suffix'. At the bottom right of the form are two buttons: 'save' and 'close'.

Video clip: Select to send video clips when a trigger is activated.

Source: Select a source of video clip.

Pre-event recording: The camera has a buffer area. It temporarily holds data up to a certain limit. Enter a number to decide the duration of recording before a trigger is activated. Up to 4 seconds can be set.

Maximum duration: Specify the maximum recording duration in seconds. Up to 20 seconds can be set. For example, if pre-event recording is set to 5 seconds and the maximum duration is set to 10 seconds, the camera continues to record for another 4 seconds after a trigger is activated.

File name prefix: Enter the text that will be appended to the front of the file name.

Click **Save** to enable the settings, then click **Close** to exit the page.

System log: Select to send a system log when a trigger is activated.

Click **Save** to enable the settings, then click **Close** to exit the page. When completed, click **Save** to enable the settings and click **Close** to exit this page. The new media settings will appear on the Event Settings page.

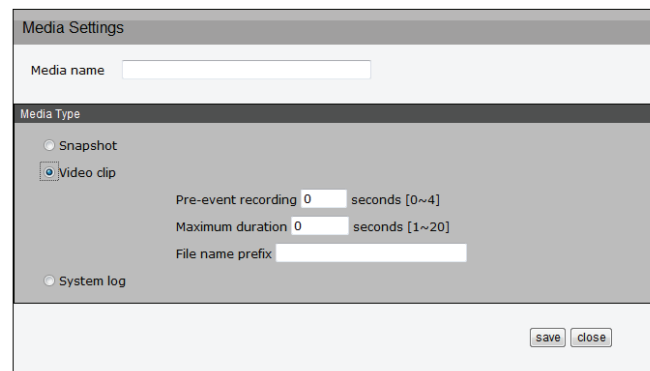

The screenshot shows the 'Media Settings' dialog box. At the top is a 'Media name' text input field. Below it is the 'Media Type' section with three radio button options: 'Snapshot', 'Video clip' (which is selected), and 'System log'. To the right of the 'Video clip' option are three input fields: 'Pre-event recording' with a value of '0' and a range of '[0~4] seconds', 'Maximum duration' with a value of '0' and a range of '[1~20] seconds', and 'File name prefix' with an empty text input field. At the bottom right of the dialog are 'save' and 'close' buttons.



The screenshot shows the 'Media Settings' dialog box. At the top is a 'Media name' text input field. Below it is the 'Media Type' section with three radio button options: 'Snapshot', 'Video clip', and 'System log' (which is selected). At the bottom right of the dialog are 'save' and 'close' buttons.

Event Settings

In the Event Settings column, click **Add** to open the Event Settings page. On this page, you can arrange three elements -- Trigger, Schedule, and Action to set an event. A total of 3 event settings can be configured.

Event name: Enter a name for the event.

Enable this event: Select to activate this event.

Trigger

This is the cause or stimulus which defines when to trigger the camera. The trigger source can be configured to use the camera's built-in motion detection mechanism or external digital input devices. There are several choices of trigger sources as shown below. Select the item to display the detailed configuration options.

Video motion detection: This option makes use of the built-in motion detection mechanism as a trigger source. To enable this function, you need to configure a Motion Detection Window first. For more information, please refer to "Motion Detection" on page 45 for details.

Digital input: This option allows the camera to use an external digital input device or sensor as a trigger source. Depending on your application, there are many choices of digital input devices on the market which help to detect changes in temperature, vibration, sound, and light, etc.

The screenshot shows the 'Event Settings' configuration page. It is divided into three main sections: 'Event name', 'Trigger', and 'Action'.
1. **Event name:** A text input field for naming the event, followed by a checkbox labeled 'Enable this event'.
2. **Trigger:** A section with radio button options: 'Video motion detection' (selected), 'Digital input 1', 'Digital input 2', 'Digital input 3', and 'Digital input 4'.
3. **Event Schedule:** A section with checkboxes for days of the week (Sun, Mon, Tue, Wed, Thu, Fri, Sat). Below this is a 'Time' section with radio button options: 'Always' (selected) and 'From 00:00 to 24:00 [hh:mm]'.
4. **Action:** A section with checkboxes for 'Trigger digital output 1' and 'Trigger digital output 2'. Below these are 'Add Server' and 'Add Media' buttons. A table-like structure follows with columns for 'Server', 'Media', and 'Extra parameter'. The 'Server' column has a checkbox for 'SD' and a dropdown menu currently set to 'None'. The 'Media' column has 'SD Test' and 'View' buttons. The 'Extra parameter' column is empty. At the bottom right of the form are 'save' and 'close' buttons.

Event Schedule

Specify the period for the event

1. Select the days of the week.
2. Select the recording schedule in 24-hr time format.

Action

Define the actions to be performed by the camera when a trigger is activated.

To set an event with recorded video or snapshots, it is necessary to configure the server and media setting so that the camera will know what action to take (i.e. the server to send the media files to) when a trigger is activated.

- **Add Server:** same as "Sever Settings" on page 47
- **Add Media:** same as "Media Settings" on page 48

The screenshot shows the 'Event Settings' configuration window. It is divided into several sections:

- Event name:** A text input field for naming the event.
- Enable this event:** A checkbox to toggle the event on or off.
- Trigger:** A section with radio buttons for selecting a trigger type: Video motion detection (selected), Digital input 1, Digital input 2, Digital input 3, and Digital input 4.
- Event Schedule:** A section with checkboxes for each day of the week (Sun, Mon, Tue, Wed, Thu, Fri, Sat). Below this is a 'Time' section with radio buttons for 'Always' (selected) and 'From 00:00 to 24:00 [hh:mm]'.
- Action:** A section with checkboxes for 'Trigger digital output 1' and 'Trigger digital output 2'. Below these are buttons for 'Add Server' and 'Add Media'. There is a table with columns for 'Server', 'Media', and 'Extra parameter'. The 'Server' column has a checkbox for 'SD' and a dropdown menu currently set to 'None'. The 'Media' column has a button for 'SD Test'. The 'Extra parameter' column has a 'View' button.
- Buttons:** 'save' and 'close' buttons are located at the bottom right of the window.

Recording Recording Settings

Click **Add** to open the recording setting page.

Schedule: Use this section to pre-determine a schedule for recording.

Recording Schedule: Specify the recording duration.

1. Select the days of the week.
2. Select the recording start and end times in 24-hr time format.

Destination: The MicroSD Card recording schedule supports up to ten sets of time frames.

Click **Save** to enable the setting and click **Close** to exit the page. When the system begins recording, it will send the recorded files to the MicroSD Card.

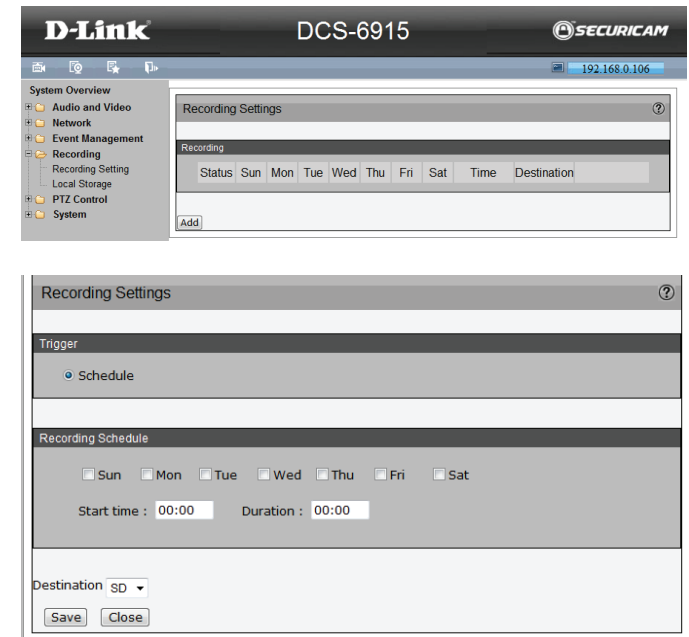

Local Storage

This section explains how to manage the local storage on the Network Camera. Here you can view SD card status, search for recorded files to playback or download.

SD Card Management

SD card status: This displays the status and reserved space on your SD card.

Note: The SD card must be formatted before using for the first time.

Enable cyclic storage: Check this item if you want to enable cyclical recording. When the maximum capacity is reached, the oldest file will be overwritten by the latest one.

Maximum duration for keeping files: Choose from the drop down list the maximum period you wish to retain a file. For example, if you enter "7 days", the recorded files will be stored on the SD card for 7 days. Click **Save** to enable your settings.

Remove oldest recordings when disc is: Enter a percentage value for the maximum capacity of the storage to be used for recordings.

Searching and Viewing the Records

This section allows the user to set up search criteria for recorded data. If you do not select any search criteria, all recorded data will be listed in the Search Results pane.

File attributes: Select one or more items as your search criteria.

Trigger time: Manually enter the time range you want to search. The recorded data corresponding to the search criteria will be listed in Search Results Window.

Search Results

This area will show the search results. There are four columns: Trigger time, Media type, Trigger type, and Locked. Click the **up** and **down** arrows to sort the search results in ascending or descending order.

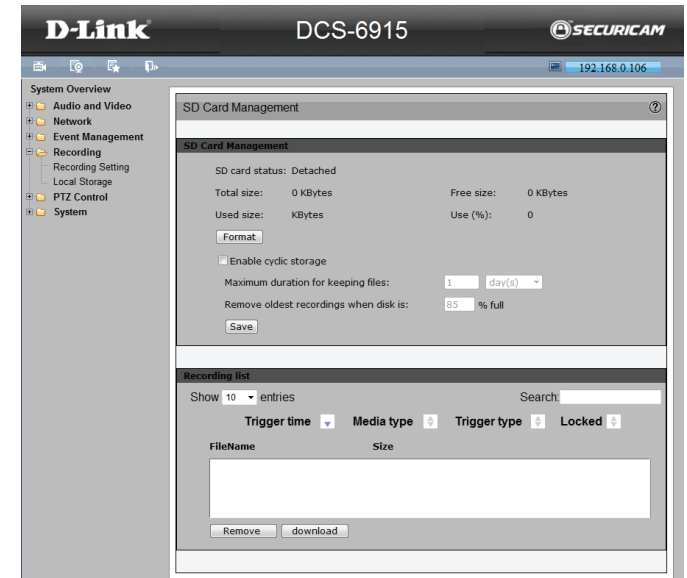

PTZ Control Preset Point

A total of 256 Preset Points can be programmed for the Network Camera.

Preset Setting: To setup a Preset Point, please first move the cursor to the live view pane. Then left click and drag the red pointer with PTZ controls to a desired position and adjust the fine zoom/ focus ratio. Subsequently, assign a number for the current position from the drop-down Number List click on **PrePage** or **NextPage** button to reach number 1 to 256, and enter its descriptive name. Click on the button **Set** to save the settings mentioned above.

Preset Go: To have the camera move to a specified Preset position, please select the Preset Point from the drop-down Preset list click on **PrePage** or **NextPage** button to reach preset number 1 to 256. Then the camera will move to the target position.

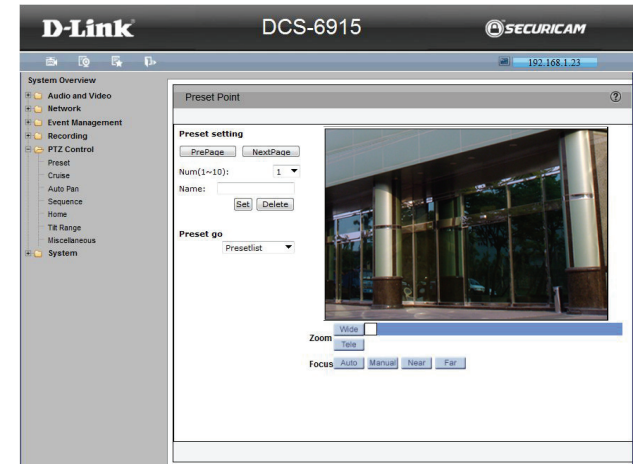

Cruise Line

The Network Camera supports up to eight Cruise Paths.

Cruise Setting: A Cruise path is a stored route defined through manual adjustment of pan, tilt, and zoom. Up to eight Cruise paths may be defined. Select the cruise path from the drop-down menu that you would like to set. Click the Record Start **Set** button to begin recording a path. Use the navigation pad or mouse to define a path within the live video window. Click the Record End **Set** button when you are finished defining the path.

Cruise Run: Select the specified Cruise Path from the drop-down list, click on the **Run** button, and then the camera will start touring around as recorded. To view the camera touring around in full screen mode, please move the cursor onto the live view pane, right-click and select **fullscreen**. To stop running a Cruise Path, simply move the cursor to the live view pane and move the camera in any direction.

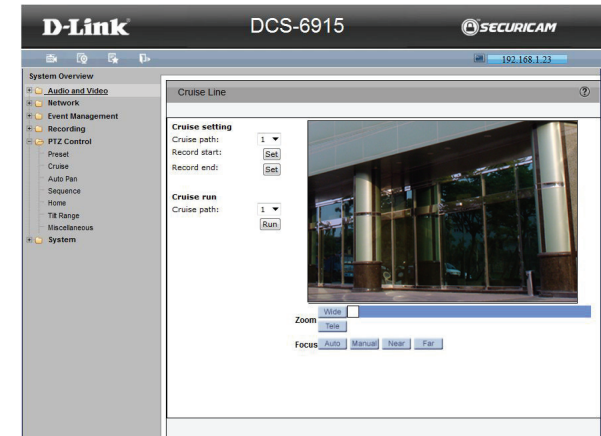

Auto Pan

Auto Pan scans an area horizontally from left to right or right to left. Up to 4 Auto Pan paths may be defined.

Auto Pan Setting: Select from the drop-down menu the path that you would like to set. Use the navigation pad to move the camera view to the desired start point and click **Set** Start Point.

Enter the speed ratio into the Speed field; the speed ratio ranges from 0 **low** to 3 **fast**. Then choose to run the Auto Pan Path in right/left direction from the Direction drop-down list. Move the camera to another desired position as the end point of the Auto Pan Path.

Move the camera view to the desired end point and click **Set** End Point. You may also specify the pan direction and speed.

Note: The zoom setting of an Auto Pan Path starting point will persist throughout the whole path.

Auto Pan Run: Select the specified Auto Pan Path from the drop-down list, click on the button, and then the camera will start moving horizontally as recorded. To view the camera panning in full screen mode, please move the cursor onto the live view pane, right-click and select **fullscreen**. To stop running an Auto Pan Path, simply move the cursor to the live view pane and move the camera in any direction.

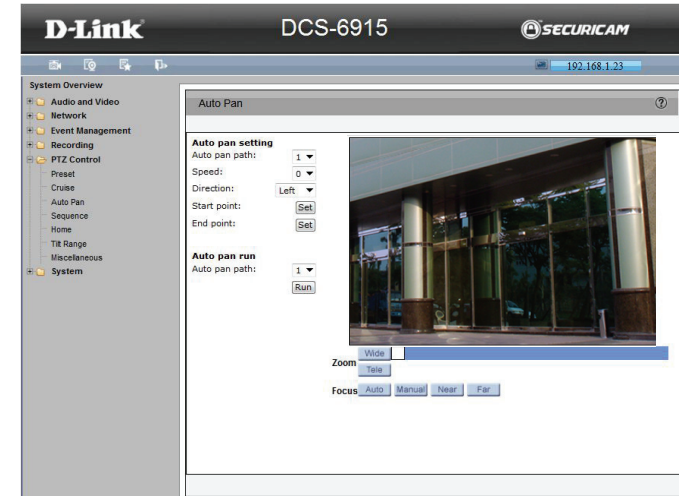

Sequence Line

The Network Camera supports eight Sequence Lines; each Sequence Line consists of up to 64 Preset Points.

Note: Before setting this function, users must pre-define at least two Preset Points.

Sequence Setting

Click on the **Edit** button in **Sequence Setting** section to enter the Sequence setting menu.

Sequence Line: Select the number of the Sequence Line to be set from the drop-down list in the top of the Sequence setting menu.

Sequential Preset Points Setting:

1. Specify a path number to use.
2. Specify up to 64 point numbers using the Prev Page and Next Page buttons to navigate between the sequence preset numbers:
 - a. Select a preset point from the Preset List.
 - b. Specify the Dwell Time.
 - c. Specify the Camera Speed.
3. Repeat steps a,b, and c, for up to 64 points.

Sequence Run

Select the specified Sequence Line from the drop-down list, click on the **Go** button, and then the camera will start moving forward each scene sequentially as programmed. To view the camera executing a Sequence Line in full screen mode, please move the cursor onto the live view pane, right-click select **fullscreen**. To stop running the Sequence Line, simply move the cursor to the live view pane and move the camera in any direction.

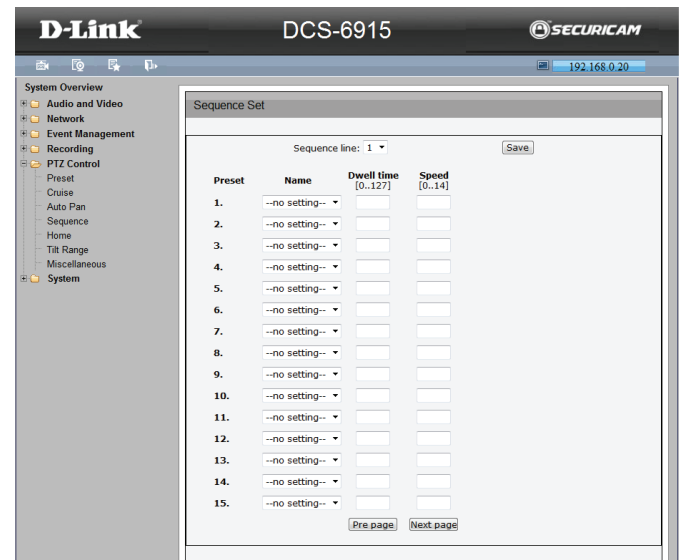
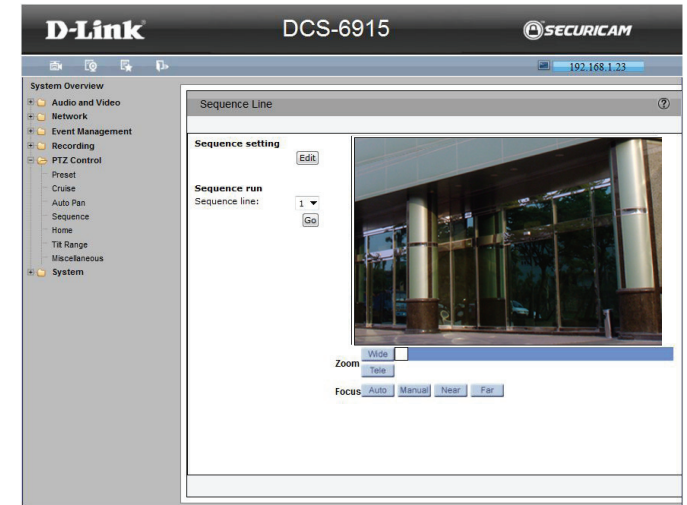

Home Function

Use this page to define the position for the **Home**  button on the PTZ control pad.

Home Setting

Switch on/off: Enable or disable the home setting.

Time

The time here represents the duration of camera idle time previous to running a Preset Point / Cruise Line / Auto Pan Path / Sequence Line. When the Home function is activated, the Dome Camera will start to count down when it idles, and then execute the predefined action as time expires. The time period ranges from 1 to 128 minutes; please specify it in the field.

Type

Please select a Action type (Preset Point / Cruise Line / Auto Pan Path / Sequence Line) and specify the number of Preset Point / Cruise Line / Auto Pan Path / Sequence Line from the drop-down <Type> and <Line> lists. Click on the button <Set> to save the Home settings.

Set Home: Position the camera as desired then click this button to set a home position

Reset Home: Set the **Home** to its default position.

Go Home: Position the camera in the Home position.

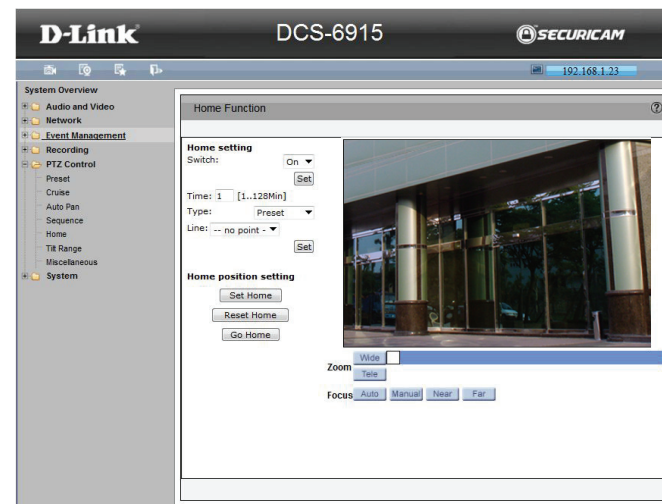

Tilt Range

The Network Camera's tilt angle is adjustable from minimum -10° to maximum 190° . Enter the desired minimum and maximum tilt angle into the corresponding fields respectively. Click on the **Set** button to save the tilt angle settings.

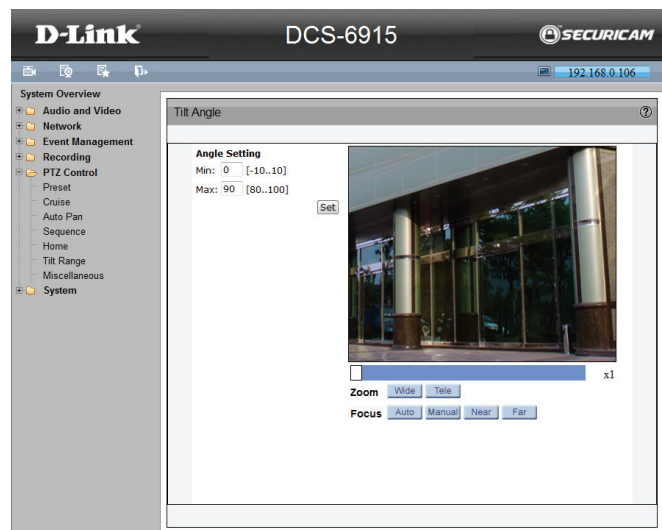

Advanced Settings

Miscellaneous

Digital Zoom:

Set the digital zoom feature to On or Off

Speed by zoom:

Adjust the pan/tilt speed automatically by internal algorithm when zooming. The larger zoom ratio leads to the lower rotating speed.

Auto Calibration:

With the Auto Calibration function, the IP Camera calibrates when the deviation of dome pivot is detected. Click on <Set> button to save the setting.

2DNR:

Set the 2DNR feature to On or Off

OSD:

Set the OSD feature to On or Off

Set Pan Zero:

Set the camera's currently shooting position as the original spot to start pan (0 degree).

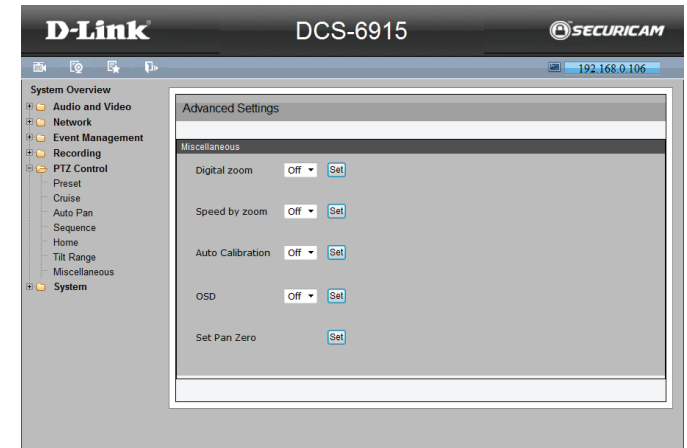

System User Settings

This section explains how to enable password protection and create multiple accounts.

Admin Password Setup:

The administrator account name is “admin”. The admin account is permanent and cannot be deleted. The default password is blank.

Add user account: Add a new user account.

Username: Enter a username for the new account.

Password: Enter a password for the new account.

Privilege: Select the access rights for the new user.

Manage user: Manage the accounts for existing users.

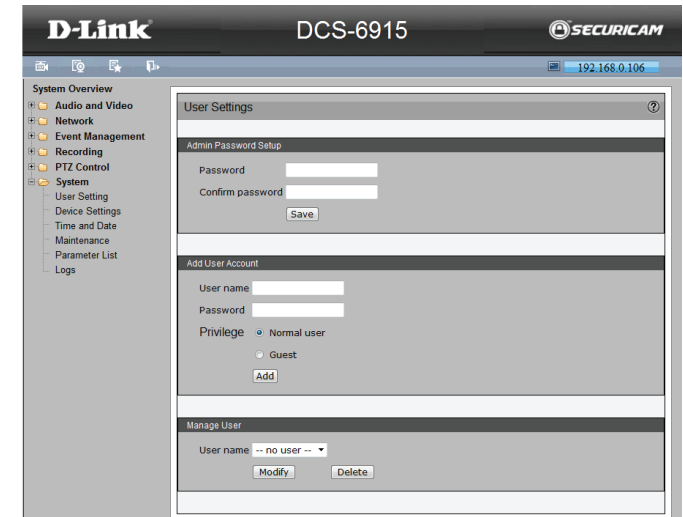

Device Settings

Use this page to set a name for the device. The name chosen will appear on the OSD overlay.

Enter a name for the camera and click **Set** to store the chosen name.

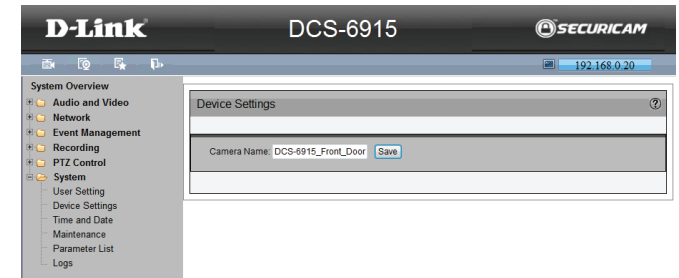

Time and Date

Host Name: This name is for camera identification. If the alarm function is enabled and is set to send an alarm message by E-Mail or FTP, the host name entered here will display in the alarm message.

Time Zone: Select the time zone you are in from the drop-down menu.

Enable Daylight Saving Time: To enable DST, select the Enable checkmark box and specify a time offset and DST duration as required. The format for time offset is [hh:mm:ss]; eg. if the amount of time offset is one hour, enter "01:00:00" into the field.

Automatic Time Configuration Sync with NTP Server: Network Time Protocol (NTP) is an alternate way to synchronize your camera's clock with an NTP server. Specify the server you wish to synchronize in the enter field, then select an update interval from the drop-down menu. For further information about NTP, see the web site: www.ntp.org.

Set the Date and Time Manually Sync With Computer Time: Select the internal clock date, time and day to synchronize with the PC's.

Manual: An administrator can set the internal clock date, time and day manually. The format is [yyyy/mm/dd] for dates and [hh:mm:ss] for time.

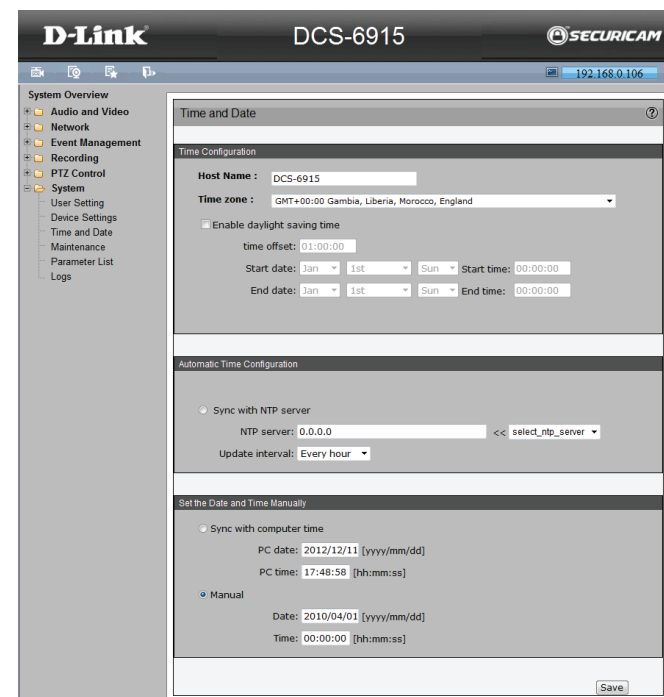

Maintenance

Reboot: Click on the **Reboot** button, and the system will restart without changing current settings.

Restore to Default: Click on the **Default** button to recall the factory default settings. The system will restart in 30 seconds.

Note: The Network Camera IP address will be restored to default.

Export Files: Users can save the system settings by exporting the configuration file .bin to a specified location for future use. Click on the **Export** button, and the popup File Download window will appear. Click on **Save** and specify a desired location for saving the configuration file.

Upload Files: To copy an existing configuration file to the IP Camera, please click on **Browse** to select the configuration file first, and then click on the **upload** button.

Firmware Upgrade: To upgrade the camera firmware click on **Browse** to locate the firmware file, then click on **Upgrade** to begin the process.

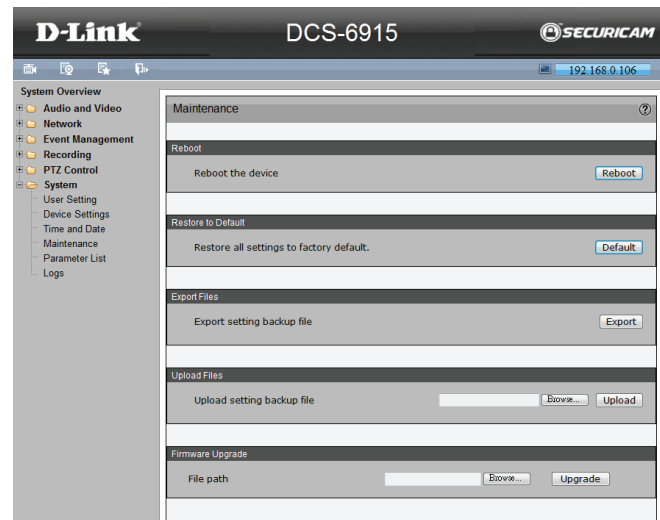

Parameter List

The Parameter list contains useful information about the current configuration of the camera which is useful for trouble shooting and diagnostics purposes.

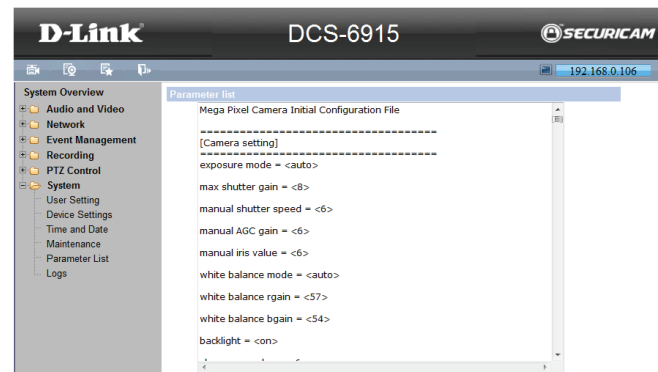

System Log

The content of the file provides useful information about configuration and connections after system boot-up which is useful for trouble shooting and diagnostics purposes.

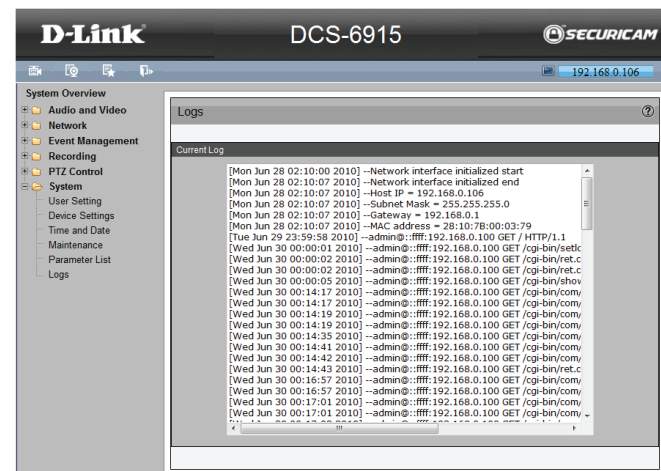

Technical Specifications

Camera		
Camera Hardware Profile	<ul style="list-style-type: none"> • Sony Exmor 1/2.8" progressive 3 Megapixel CMOS sensor • Minimum illumination 0.1 lux (Color); 0.01 Lux (B/W) • Built-in Infrared-Cut Removable (ICR) Filter • Electronic shutter 1 to 1/10,000 sec. • Variable 20x optical zoom, 10x digital zoom 	<ul style="list-style-type: none"> • Focal length 4.7 to 94 mm • Angle of View <ul style="list-style-type: none"> • (D) 64.42° to 4.65° • (H) 52.27° to 4.07° • (V) 33.4° to 2.33°
PTZ Hardware Profile	<ul style="list-style-type: none"> • Pan travel: 360° endless • Tilt Travel: -10° to 190° • Presets: 64 points • Preset Accuracy: ± 0.225° • Preset Speed: 5° to 400°/s • Sequence Paths: 8 • Auto Pan Paths: 4 	<ul style="list-style-type: none"> • Cruise Paths: 8 • Pan and tilt speed proportional to zoom ratio • Resume after power loss • Home Function: Preset, Sequence, Auto pan, Cruise • Auto Flip: Mechanical/Digital/Off • Digital Slow Shutter • Image Freeze
Image Features	<ul style="list-style-type: none"> • Configurable image size, quality, frame rate, and bit rate • Time stamp and text overlays • Configurable motion detection windows 	<ul style="list-style-type: none"> • 16 configurable privacy masks • Configurable shutter speed, Iris, exposure gain, sharpness, BLC, WDR • Auto flip
Video Compression	<ul style="list-style-type: none"> • Simultaneous H.264/MJPEG format compression • H.264 multicast streaming 	<ul style="list-style-type: none"> • JPEG for still images
Video Resolution	<ul style="list-style-type: none"> • 1920 x 1080 (1080P) • 1280 x 720 (720P) • 720 x 480 (D1) • 800 x 600 (SVGA) 	<ul style="list-style-type: none"> • 1024 x 768 (XGA) • 1280 x 1024 (SXGA) • 640 x 480 (VGA) • 320 x 240 (CIF)
Audio Support	<ul style="list-style-type: none"> • G.711 	
External Device Interfaces	<ul style="list-style-type: none"> • 4 alarm inputs • 2 alarm outputs 	<ul style="list-style-type: none"> • Audio input/output
Network		
Network Protocols	<ul style="list-style-type: none"> • IPv4 • TCP/IP • UDP • ICMP • DHCP Client • NTP Client (D-Link) • DNS Client • DDNS Client (D-Link) • SMTP Client • FTP Client 	<ul style="list-style-type: none"> • HTTP • PPPoE • UPnP Port Forwarding • RTP/RTSP • IP filtering • IEEE802.1x • QoS • SNMP • ONVIF Compliant
Security	<ul style="list-style-type: none"> • Administrator and user group protection 	<ul style="list-style-type: none"> • Password authentication

Appendix A: Technical Specifications

System Management		
System Requirements for Web Interface	<ul style="list-style-type: none"> • Microsoft Windows 8/7/Vista/XP/2000 	<ul style="list-style-type: none"> • Internet Explorer, Chrome, Firefox, or Safari
Event Management	<ul style="list-style-type: none"> • Motion detection • Event notification and upload snapshots/video clips via SMTP or FTP 	<ul style="list-style-type: none"> • Multiple event notification • Multiple recording methods for easy backup • Supports multiple SMTP and FTP servers
Remote Management	<ul style="list-style-type: none"> • Configuration accessible via web browser 	<ul style="list-style-type: none"> • Take snapshots/video clips and save to local storage
D-ViewCam™ System Requirements	<ul style="list-style-type: none"> • Operating System: Microsoft Windows 7/Vista/XP • Web Browser: Internet Explorer 7 or higher 	<ul style="list-style-type: none"> • Protocol: Standard TCP/IP
D-ViewCam™ Software Functions	<ul style="list-style-type: none"> • Remote management/control of up to 32 cameras • Viewing of up to 32 cameras on one screen 	<ul style="list-style-type: none"> • Supports all management functions provided in web interface • Scheduled motion triggered, or manual recording options
General		
Power Input	<ul style="list-style-type: none"> • AC 24 V, 3 A 	
Max. Power Consumption	<ul style="list-style-type: none"> • Max 65 W with heater on 	
Operating Temperature	<ul style="list-style-type: none"> • -40 to 50 °C (-40 to 122 °F) 	
Storage Temperature	<ul style="list-style-type: none"> • -20 to 70 °C (-4 to 158 °F) 	
Weatherproof	<ul style="list-style-type: none"> • IP-66 standard 	
Vandal-proof	<ul style="list-style-type: none"> • IK-10 standard 	
Humidity	<ul style="list-style-type: none"> • 20% to 80% non-condensing 	
Weight	<ul style="list-style-type: none"> • 2.32 kg (5.11 lbs), with sunshield 	
Certifications	<ul style="list-style-type: none"> • CE (Class A) • CE LVD (EN60965-1) • FCC (Class A) 	<ul style="list-style-type: none"> • ICES-003 • C-Tick

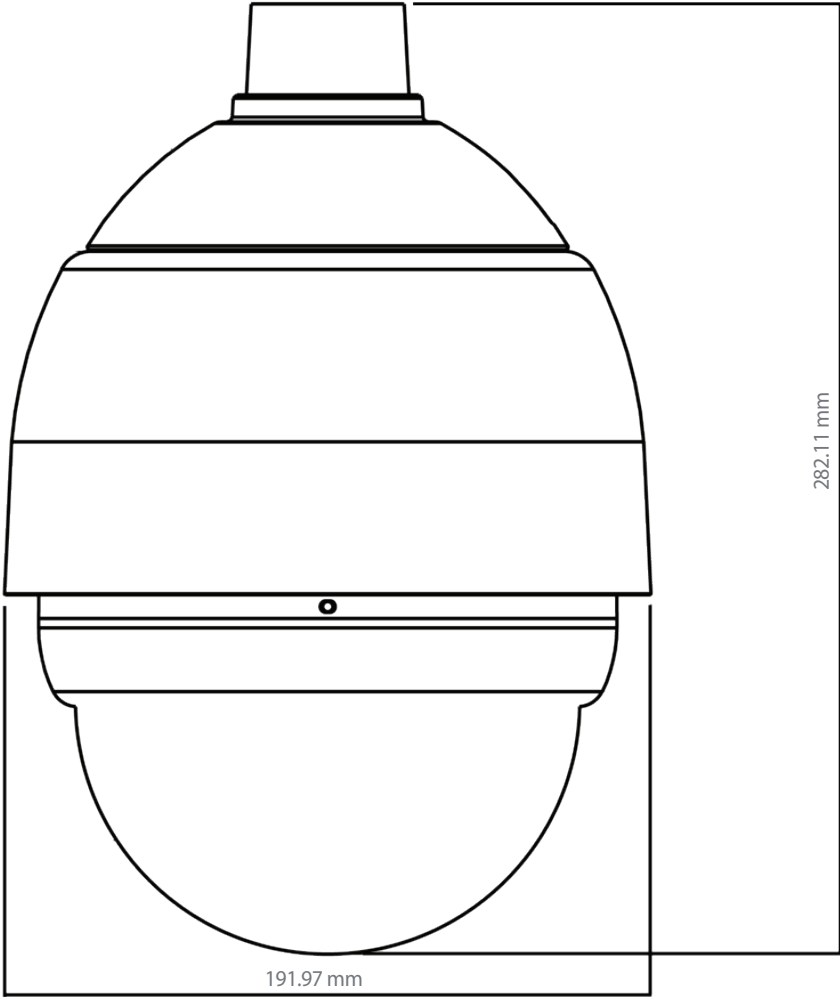
<p>Dimensions</p>	 <p>The diagram shows a technical drawing of a dome-shaped camera. It features a small rectangular protrusion at the top, a rounded dome body, and a mounting bracket at the bottom. Two dimensions are indicated: a horizontal dimension of 191.97 mm at the base and a vertical dimension of 282.11 mm on the right side.</p>
-------------------	--

Appendix A: Technical Specifications

Optional Accessories		
DCS-32-1	Long Straight Tube, 500 mm, 50 mm diameter, 1.5 kg	
DCS-32-2	Short Straight Tube, 250 mm, 45 mm diameter, 1 kg	
DCS-32-3	Standard Pendant Mount, 348 x 104 x 138.6 mm, 1.5 kg	
DCS-32-4	Mini Pendant Mount, 204 x 124 x 135.2 mm, 1.2 kg	
DCS-80-5	Power Box, 187 x 147 x 76 mm, 2 kg, 100 to 115 V AC	
DCS-80-6	Power Box, 187 x 147 x 76 mm, 2 kg, 220 to 230 V AC	

Connection Panel Pin Definition

Power Socket: This is 3 pin socket accepts the power cable.

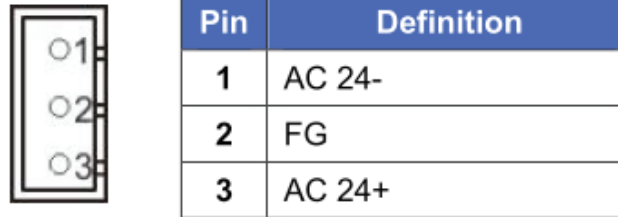

Alarm I/O: Support two digital alarm outputs and four digital alarm inputs.

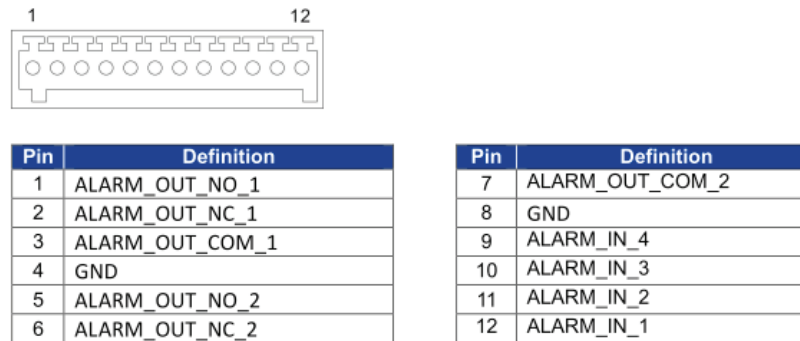

Audio I/O: Support one audio input and one audio output.

