

Latitude 3440

Setup and Specifications

Notes, cautions, and warnings

 **NOTE:** A NOTE indicates important information that helps you make better use of your product.

 **CAUTION:** A CAUTION indicates either potential damage to hardware or loss of data and tells you how to avoid the problem.

 **WARNING:** A WARNING indicates a potential for property damage, personal injury, or death.

Contents

Chapter 1: Set up your Latitude 3440.....	4
Chapter 2: Views of Latitude 3440.....	6
Right.....	6
Left.....	6
Top.....	7
Display.....	8
Bottom.....	9
Service Tag.....	9
Battery charge and status light	10
RJ45 status LED.....	11
Chapter 3: Specifications of Latitude 3440.....	12
Dimensions and weight.....	12
Processor.....	12
Chipset.....	13
Operating system.....	13
Memory.....	13
External ports.....	14
Internal slots.....	14
Ethernet.....	14
Wireless module.....	15
WWAN module.....	15
Audio.....	16
Storage.....	17
Keyboard.....	17
Camera.....	18
Touchpad.....	18
Power adapter.....	19
Battery.....	20
Display.....	21
Fingerprint reader.....	22
Sensor	22
GPU—Integrated.....	22
GPU—Discrete.....	23
Multiple display support matrix.....	23
Hardware security.....	23
Operating and storage environment.....	23
Chapter 4: Keyboard shortcuts of Latitude 3440.....	25
Chapter 5: Getting help and contacting Dell.....	27

Set up your Latitude 3440

NOTE: The images in this document may differ from your computer depending on the configuration you ordered.

1. Connect the power adapter and press the power button.



NOTE: To conserve battery power, the battery might enter power saving mode. Connect the power adapter and press the power button to turn on the computer.

2. Finish operating system setup.

For Ubuntu:

Follow the on-screen instructions to complete the setup. For more information about installing and configuring Ubuntu, search in the Knowledge Base Resource at [Dell Support Site](#).

For Windows:





Follow the on-screen instructions to complete the setup. When setting up, Dell Technologies recommends that you:

- Connect to a network for Windows updates.
 - NOTE:** If connecting to a secured wireless network, enter the password for the wireless network access when prompted.
- If connected to the Internet, sign-in with or create a Microsoft account. If not connected to the Internet, create an offline account.

- On the **Support and Protection** screen, enter your contact details.

3. Locate and use Dell apps from the Windows Start menu—Recommended.

Table 1. Locate Dell apps

Resources	Description
	<p>Dell Product Registration Register your computer with Dell.</p>
	<p>Dell Help & Support Access help and support for your computer.</p>
	<p>SupportAssist SupportAssist is the smart technology that keeps your computer running at its best by optimizing settings, detecting issues, removing viruses and notifies when you need to make system updates. SupportAssist proactively checks the health of your system's hardware and software. When an issue is detected, the necessary system state information is sent to Dell to begin troubleshooting. SupportAssist is preinstalled on most of the Dell devices running Windows operating system. For more information, see SupportAssist for Home PCs User's Guide on Serviceability Tools at the Dell Support Site. NOTE: In SupportAssist, click the warranty expiry date to renew or upgrade your warranty.</p>
	<p>Dell Update Updates your computer with critical fixes and latest device drivers as they become available. For more information about using Dell Update, search in the Knowledge Base Resource at Dell Support Site.</p>
	<p>Dell Digital Delivery Download software applications, which are purchased but not preinstalled on your computer. For more information about using Dell Digital Delivery, search in the Knowledge Base Resource at Dell Support Site.</p>

Views of Latitude 3440

Right



1. microSIM card slot (optional)
2. USB 3.2 Gen 1 port
3. RJ-45 Ethernet port
4. Ethernet status LED
5. Wedge-shaped lock slot

Left

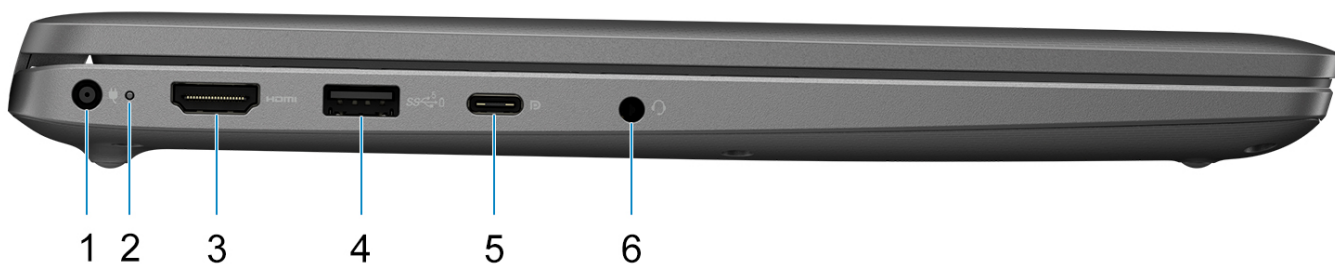

1. DC-in port
2. Battery-status light/Diagnostic-status light
3. HDMI 1.4 port
4. USB 3.2 Gen 1 port with PowerShare
5. USB 3.2 Gen 2 Type-C port with Power Delivery and DisplayPort Alt mode
6. Universal audio port

Top

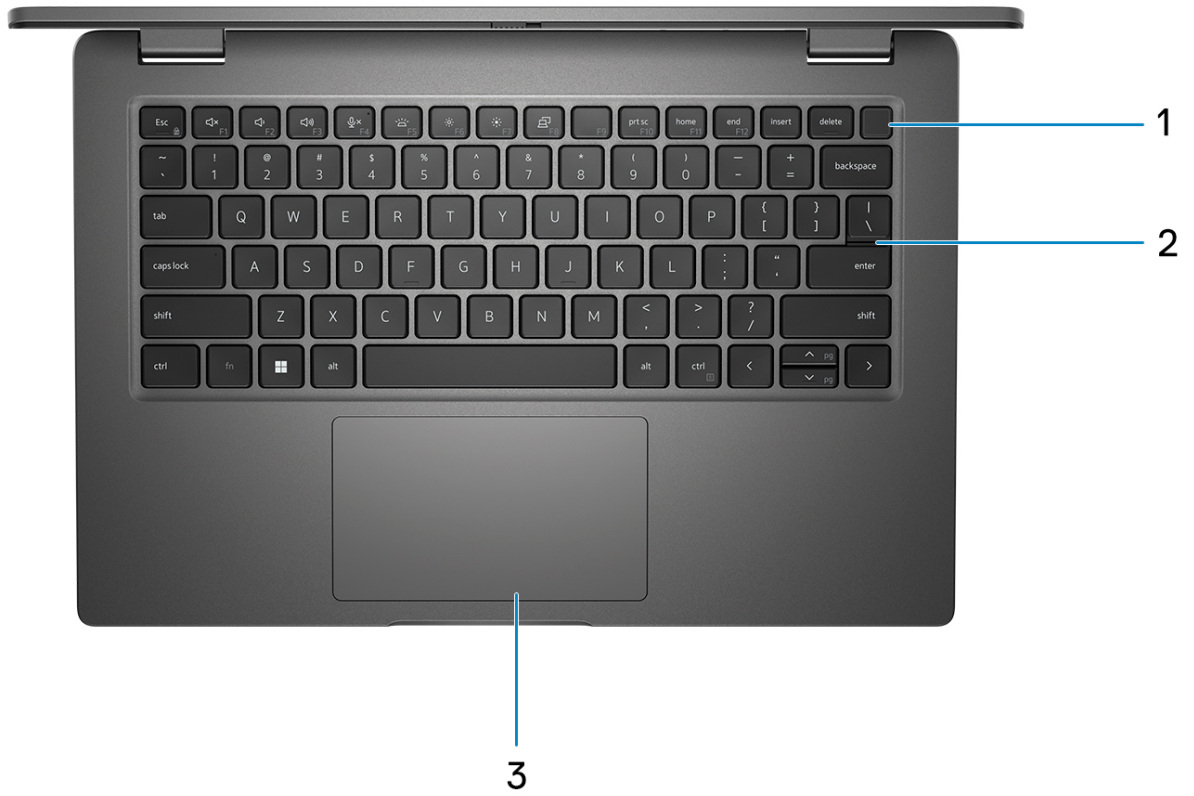

1. Power button with optional fingerprint reader
2. Keyboard
3. Touchpad

Display

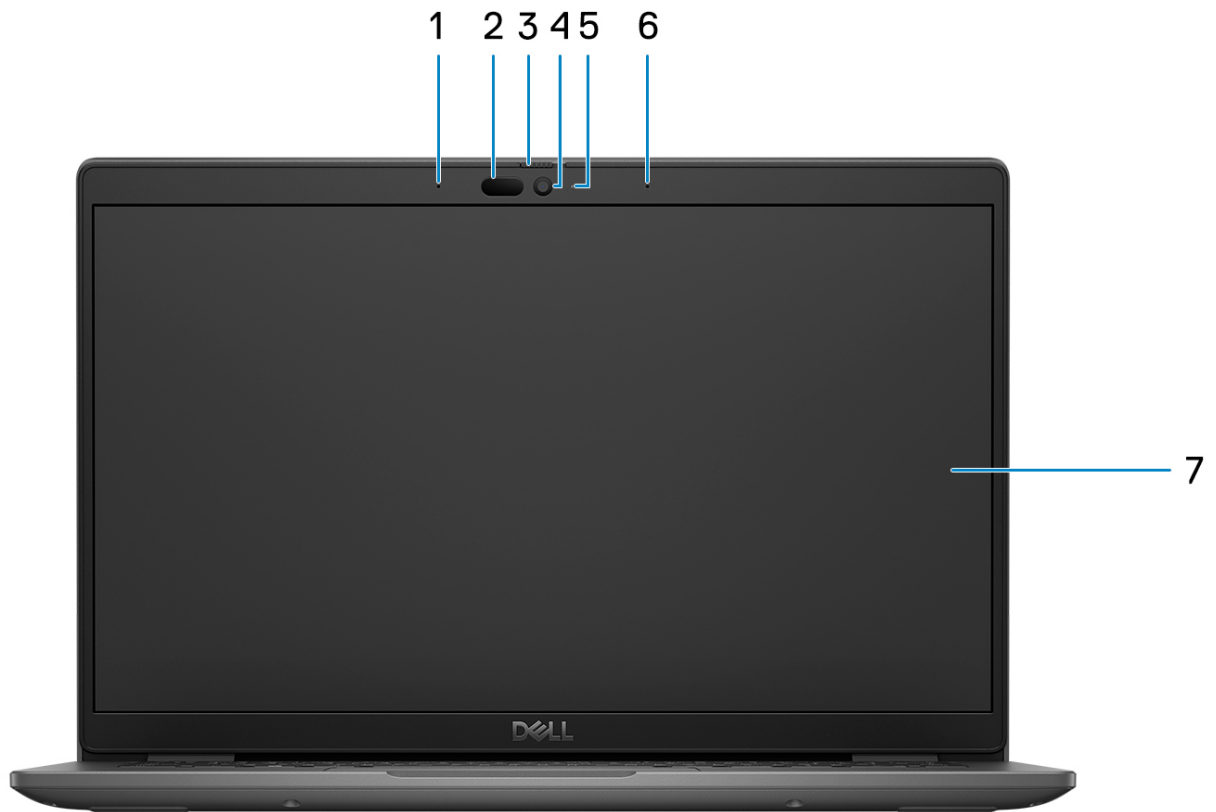

1. Digital-array microphone
2. IR camera and emitter (optional)
3. Camera shutter
4. RGB camera (HD/FHD)
5. Camera status LED
6. Digital-array microphone
7. LCD panel

Bottom

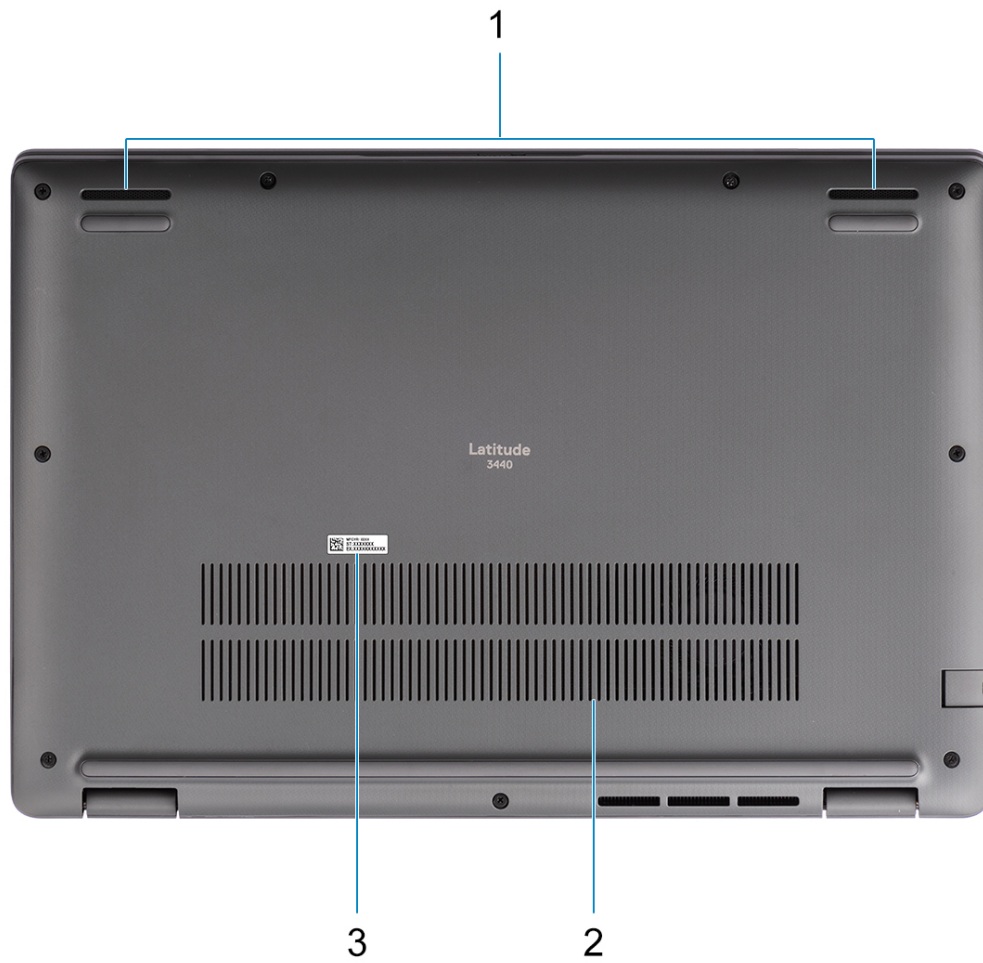

1. Speaker mesh
2. Air vents
3. Service Tag and regulatory labels

Service Tag

The service tag is a unique alphanumeric identifier that allows Dell service technicians to identify the hardware components in your computer and access warranty information.

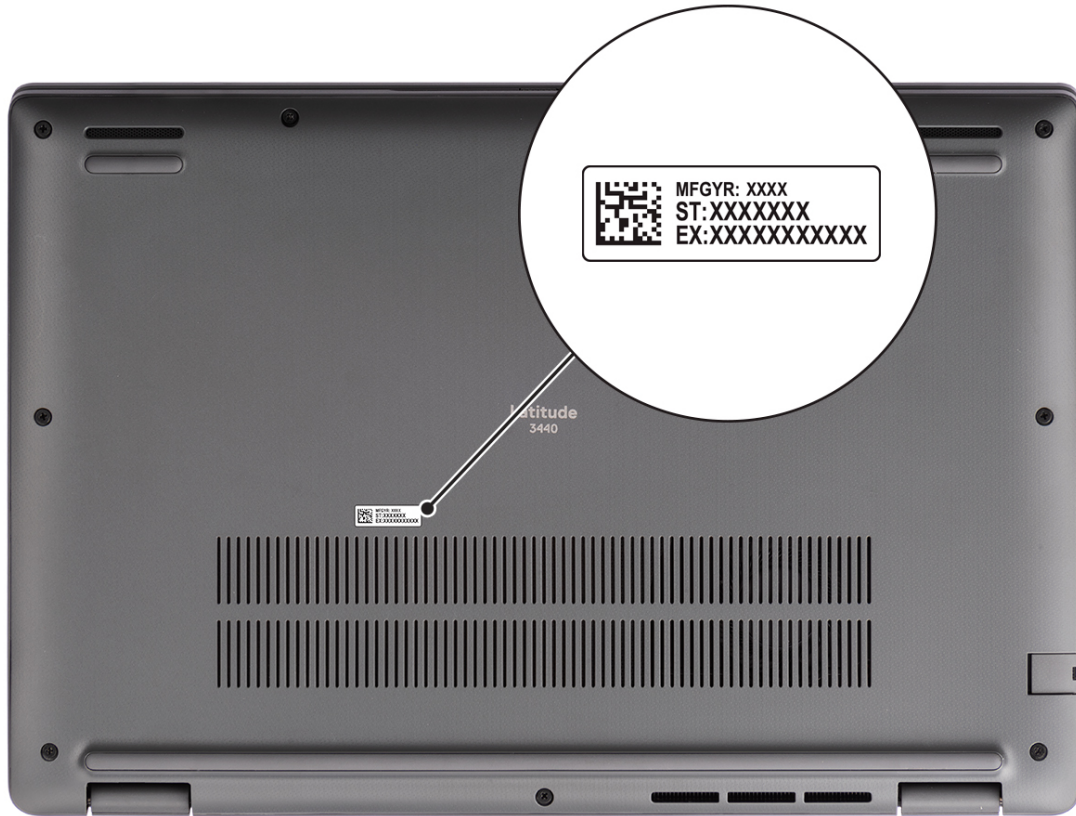

Battery charge and status light

The following table lists the battery charge and status light behavior of your Latitude 3440.

Table 2. Battery charge and status light behavior

Power Source	LED Behavior	System Power State	Battery Charge Level
AC Adapter	Off	S0 - S5	Fully Charged
AC Adapter	Solid White	S0 - S5	< Fully Charged
Battery	Off	S0 - S5	11-100%
Battery	Solid Amber (590+/-3 nm)	S0 - S5	< 10%

- S0 (ON) - System is turned on.
- S4 (Hibernate) - The system consumes the least power compared to all other sleep states. The system is almost at an OFF state, except for a trickle power. The context data is written to a hard drive.
- S5 (OFF) - The system is in a shutdown state.

RJ45 status LED

The following table lists the RJ45 status LED behavior of your Latitude 3440.

Table 3. RJ45 status LED behavior

LED behavior	Connection status
Solid amber	The RJ45 cable is connected properly from the router or switch to the computer. The connection is active.
Blinking amber	Data transfer is in progress.

Specifications of Latitude 3440

Dimensions and weight

The following table lists the height, width, depth, and weight of your Latitude 3440.

Table 4. Dimensions and weight

Description	UMA graphics configurations	Discrete graphics configurations
Height:		
Front height	0.70 in. (17.68 mm)	0.70 in. (17.68 mm)
Rear height	0.76 in. (19.37 mm)	0.80 in. (20.42 mm)
Width	12.68 in. (322.17 mm)	12.68 in. (322.17 mm)
Depth	8.63 in. (219.43 mm)	8.63 in. (219.43 mm)
Weight i NOTE: The weight of your computer depends on the configuration ordered and manufacturing variability.	<ul style="list-style-type: none"> Minimum—1.54 kg (3.40 lbs) 	<ul style="list-style-type: none"> Minimum—1.59 kg (3.51 lbs)

Processor

The following table lists the details of the processors that are supported for your Latitude 3440.

Table 5. Processor

Description	Option one	Option two	Option three	Option four	Option five	Option six	Option seven	Option eight
Processor type	12 th Generation Intel Celeron 7305	12 th Generation Intel Core i3-1215U	12 th Generation Intel Core i5-1235U	12 th Generation Intel Core i5-1245U	13 th Generation Intel Core i3-1315U	13 th Generation Intel Core i5-1335U	13 th Generation Intel Core i5-1345U	13 th Generation Intel Core i7-1355U
Processor wattage	15 W	15 W	15 W	15 W	15 W	15 W	15 W	15 W
Processor core count	5	6	10	10	6	10	10	10
Processor thread count	5	8	12	12	8	12	12	12
Processor speed	Up to 1.10 GHz	Up to 4.40 GHz	Up to 4.40 GHz	Up to 4.40 GHz	Up to 4.50 GHz	Up to 4.60 GHz	Up to 4.70 GHz	Up to 5.00 GHz
Processor cache	8 MB	10 MB	12 MB	12 MB	10 MB	12 MB	12 MB	12 MB

Table 5. Processor (continued)

Description	Option one	Option two	Option three	Option four	Option five	Option six	Option seven	Option eight
Integrated graphics	Intel UHD Graphics	Intel UHD Graphics	Intel Iris Xe Graphics	Intel Iris Xe Graphics	Intel Iris Xe Graphics	Intel Iris Xe Graphics	Intel Iris Xe Graphics	Intel Iris Xe Graphics

Chipset

The following table lists the details of the chipset that is supported for your Latitude 3440.

Table 6. Chipset

Description	Option one	Option two
Processors	12 th Generation Intel Celeron processor 7305 and 12 th Generation Intel Core i3	13 th Generation Intel Core i3/i5/i7
Chipset	Intel ADL-U (integrated with the processor)	Intel RPL-U (integrated with the processor)
DRAM bus width	64 bit	64 bit
Flash EPROM	32 MB	32 MB
PCIe bus	Up to Gen 4.0	Up to Gen 4.0

Operating system

Your Latitude 3440 supports the following operating systems:

- Windows 11 Pro
- Windows 11 Home
- Windows 11 Pro Downgrade (Windows 10 image factory installed)
- Ubuntu 22.04 LTS, 64-bit

Memory

The following table lists the memory specifications of your Latitude 3440.

Table 7. Memory specifications

Description	Values
Memory slots	Two
Memory type	DDR4, single-channel, dual-channel
Memory speed	3200 MT/s
Maximum memory configuration	64 GB
Minimum memory configuration	8 GB
Memory size per slot	8 GB, 16 GB, 32 GB
Memory configurations supported	<ul style="list-style-type: none"> • 8 GB, DDR4, 3200 MT/s

Table 7. Memory specifications (continued)

Description	Values
	<ul style="list-style-type: none"> • 16 GB, DDR4, 3200 MT/s • 32 GB, DDR4, 3200 MT/s • 64 GB, DDR4, 3200 MT/s

External ports

The following table lists the external ports of your Latitude 3440.

Table 8. External ports

Description	Values
Network port	One Flip-down RJ 45 10/100/1000 Mbps
USB ports	<ul style="list-style-type: none"> • One USB 3.2 Gen 2 Type-C port with Power Delivery and DisplayPort Alt mode • One USB 3.2 Gen 1 port with PowerShare • Two USB 3.2 Gen 1 port
Audio port	One universal audio port
Video port	One HDMI 1.4 port
SIM card slot	One microSIM-card slot (for WWAN configurations only)
Power-adaptor port	One DC-in port (4.5 mm standard plug/USB-C port)
Security-cable slot	One wedge-shaped lock slot

Internal slots

The following table lists the internal slots of your Latitude 3440.

Table 9. Internal slots

Description	Values
M.2	<ul style="list-style-type: none"> • One M.2 (2280 or 2230) for solid-state drive • One M.2 3042 slot for WWAN card • One M.2 2230 slot for WLAN card <p> NOTE: To learn more about the features of different types of M.2 cards, search in the Knowledge Base Resource at Dell Support Site.</p>

Ethernet

The following table lists the wired Ethernet Local Area Network (LAN) specifications of your Latitude 3440.

Table 10. Ethernet specifications

Description	Values
Model number	RTL8111H-CG

Table 10. Ethernet specifications (continued)

Description	Values
Transfer rate	10/100/1000 Mbps

Wireless module

The following table lists the Wireless Local Area Network (WLAN) modules that are supported on your Latitude 3440.

Table 11. Wireless module specifications

Description	Option one	Option two
Model number	Intel AX211	Realtek RTL8852BE
Transfer rate	Up to 2400 Mbps	Up to 1200 Mbps
Frequency bands supported	2.4 GHz/5 GHz/6 GHz	2.4 GHz/5 GHz
Wireless standards	<ul style="list-style-type: none"> • WiFi 802.11a/b/g • Wi-Fi 4 (WiFi 802.11n) • Wi-Fi 5 (WiFi 802.11ac) • Wi-Fi 6E (WiFi 802.11ax) • Wi-Fi 6 (WiFi 802.11ax) 	<ul style="list-style-type: none"> • WiFi 802.11a/b/g • Wi-Fi 4 (WiFi 802.11n) • Wi-Fi 5 (WiFi 802.11ac) • Wi-Fi 6 (WiFi 802.11ax)
Encryption	<ul style="list-style-type: none"> • 64-bit/128-bit WEP • AES-CCMP • TKIP 	<ul style="list-style-type: none"> • 64-bit/128-bit WEP • AES-CCMP • TKIP
Bluetooth wireless card	Bluetooth 5.3	Bluetooth 5.3
	 NOTE: The version of the Bluetooth wireless card may vary depending on the operating system that is installed on your computer.	

WWAN module

The following table lists the Wireless Wide Area Network (WWAN) module supported on your Latitude 3440.

Table 12. WWAN module specifications

Description	Values
Model number	Inter(R) XMM7560 R+LTE-A (DW5823e)
Form factor	M.2 S3 KEY-B
Host interface	PCIe Gen 2
Network standard	<ul style="list-style-type: none"> • LTE FDD/TDD, WCDMA/HSPA+ • GPS/GLONASS/Beidou/Galileo
Transfer rate	<ul style="list-style-type: none"> • Downlink: • LTE FDD: 1 Gbps (Cat16) • LTE TDD: 756 Mbps (Cat 16) • UMTS: 384 Kbps

Table 12. WWAN module specifications (continued)

Description	Values
	<ul style="list-style-type: none"> DC-HSPA+: 42 Mbps (Cat24) Uplink: LTE FDD: 150 Mbps (Cat13) LTE TDD: 90 Mbps (Cat13) UMTS: 384 Kbps DC-HSPA+: 5.76 Mbps (Cat6)
Operating frequency bands	<ul style="list-style-type: none"> LTE FDD (B1, B2, B3, B4, B5, B7, B8, B12, B13, B14, B17, B18, B19, B20, B25, B26, B28, B29, B30, B32, B66, B71) LTE TDD (B34, B38, B39, B40, B41, B42, B43, B46 (receiver only), B48) WCDMA (B1, B2, B4, B5, B8)
Power supply	DC 3.135 V to 4.4 V, Typical 3.3 V
SIM card	Supported through external or internal SIM-card slot
eSIM with Dual SIM (DSSA)	Supported (The availability of eSIM functionality embedded on the module is dependent on the region and specific carrier requirements)
Antenna Diversity	Supported
Radio On/Off	Supported
Wake On Wireless	Not supported
Temperature	<ul style="list-style-type: none"> Normal operating temperature: -10 °C to +55 °C Extended operating temperature: -20 °C to +65 °C Storage Temperature: -40 °C to +85 °C
Antenna connector	<ul style="list-style-type: none"> WWAN Main Antenna x 1 WWAN Diversity Antenna x 1
 NOTE: For instructions on how to find your computer's IMEI (International Mobile Station Equipment Identity) number, search in the Knowledge Base Resource at Dell Support Site .	

Audio

The following table lists the audio specifications of your Latitude 3440.

Table 13. Audio specifications

Description	Values
Audio controller	Realtek ALC3204
Stereo conversion	Supported with Waves MaxxAudio Pro
Internal audio interface	High definition audio interface
External audio interface	One universal audio port
Number of speakers	Two
Internal-speaker amplifier	Supported (audio codec integrated)
External volume controls	Supported

Table 13. Audio specifications (continued)

Description	Values
Speaker output:	
Average speaker output	2 W x 2 = 4 W
Peak speaker output	2.5 W x 2 = 5 W
Subwoofer output	Not supported
Microphone	Digital-array microphone

Storage

This section lists the storage options on your Latitude 3440.

One M.2 2230/2280 solid-state drive

Table 14. Storage specifications

Storage type	Interface type	Capacity
M.2 2230 Class 35 SSD	PCIe NVMe Gen4 x4	Up to 1 TB
M.2 2280 Class 40 SSD	PCIe NVMe Gen4 x4	Up to 1 TB

Keyboard

The following table lists the keyboard specifications of your Latitude 3440.

Table 15. Keyboard specifications

Description	Values
Keyboard type	<ul style="list-style-type: none"> Standard backlit keyboard without fingerprint reader Standard backlit keyboard with fingerprint reader Standard non-backlit keyboard without fingerprint reader Standard non-backlit keyboard with fingerprint reader
Keyboard layout	QWERTY
Number of keys	<ul style="list-style-type: none"> United States and Canada: 79 keys United Kingdom: 80 keys Japan: 83 keys
Keyboard size	X=19.05 mm key pitch Y=18.05 mm key pitch
Keyboard shortcuts	<p>Some keys on your keyboard have two symbols on them. These keys can be used to type alternate characters or to perform secondary functions. To type the alternate character, press Shift and the desired key. To perform secondary functions, press Fn and the desired key.</p> <p>NOTE: You can define the primary behavior of the function keys (F1–F12) changing Function Key Behavior in BIOS setup program.</p> <p>NOTE:</p>

Table 15. Keyboard specifications (continued)

Description	Values
	If Copilot in Windows is not available on your computer, the Copilot key launches Windows Search. For more information about Copilot in Windows, search in the Knowledge Base Resource at dell support .

Camera

The following table lists the camera specifications of your Latitude 3440.

Table 16. Camera specifications

Description	Values
Number of cameras	One
Camera type	<ul style="list-style-type: none"> • HD RGB • FHD RGB • FHD RGB + IR
Camera location	Front camera
Camera sensor type	CMOS sensor technology
Camera resolution:	
Still image	<ul style="list-style-type: none"> • 0.92 megapixels (HD) • 2.07 megapixels (FHD)
Video	<ul style="list-style-type: none"> • 1280 x 720 (HD) at 30 fps • 1920 x 1080 (FHD) at 30 fps
Infrared camera resolution:	
Still image	0.23 megapixel
Video	640 x 360 at 15 fps
Diagonal viewing angle:	
Camera	<ul style="list-style-type: none"> • 78.6 degrees (HD) • 80 degrees (FHD)
Infrared camera	86.6 degrees

Touchpad

The following table lists the touchpad specifications of your Latitude 3440.

Table 17. Touchpad specifications

Description	Values
Touchpad resolution:	>300 dpi
Touchpad dimensions:	

Table 17. Touchpad specifications (continued)

Description		Values
	Horizontal	115 mm
	Vertical	67 mm
Touchpad gestures		For more information about touchpad gestures available on Windows, see the Microsoft Knowledge Base article at Microsoft Support Site .

Power adapter

The following table lists the power adapter specifications of your Latitude 3440.

Table 18. Power adapter specifications

Description	Option one	Option two	Option three
Type	60 W AC adapter, USB-C	65 W AC adapter, 4.5 mm barrel	65 W adapter USB-C
Connector dimensions:			
External diameter	N/A	4.50 mm	N/A
Internal diameter	N/A	2.90 mm	N/A
Power-adapter dimensions:			
Height	22 mm (0.86 in.)	29 mm (1.14 in.)	28 mm (1.10 in.)
Width	55 mm (2.16 in.)	47 mm (1.85 in.)	51 mm (2.01 in.)
Depth	66 mm (2.59 in.)	108 mm (4.25 in.)	112 mm (4.41 in.)
Input voltage	100 VAC to 240 VAC	100 VAC - 240 VAC	100 VAC - 240 VAC
Input frequency	50 Hz to 60 Hz	50 Hz - 60 Hz	50 Hz - 60 Hz
Input current (maximum)	1.70 A	1.60 A/1.70 A	1.70 A
Output current (continuous)	<ul style="list-style-type: none"> ● 20 V/3 A ● 15 V/3 A ● 9 V/3 A ● 5 V/3 A 	3.34 A	<ul style="list-style-type: none"> ● 20 V/3.25 A (Continuous) ● 15 V/3 A (Continuous) ● 9.0 V/3 A (Continuous) ● 5.0 V/3 A (Continuous)
Rated output voltage	<ul style="list-style-type: none"> ● 20 VDC ● 15 VDC ● 9 VDC ● 5 VDC 	19.50 VDC	<ul style="list-style-type: none"> ● 20 VDC ● 15 VDC ● 9 VDC ● 5 VDC
Temperature range:			
Operating	0°C to 40°C (32°F to 104°F)	0°C to 40°C (32°F to 104°F)	0°C to 40°C (32°F to 104°F)
Storage	-40°C to 70°C (-40°F to 158°F)	-40°C to 70°C (-40°F to 158°F)	-40°C to 70°C (-40°F to 158°F)

Table 18. Power adapter specifications (continued)

Description	Option one	Option two	Option three
 CAUTION: Operating and storage temperature ranges may differ among components, so operating or storing the device outside these ranges may impact the performance of specific components.			

Battery

The following table lists the battery specifications of your Latitude 3440.

Table 19. Battery specifications

Description	Option one	Option two	Option three	Option four
Battery type	3-cell, 42 Wh, Lithium-ion, ExpressCharge	3-cell, 54 Wh, Lithium-ion, ExpressCharge	3-cell, 42 Wh, Long Life Cycle, ExpressCharge 1.0	3-cell, 54 Wh, Long Life Cycle, ExpressCharge 1.0
Battery voltage	11.4 V	11.4 V	11.4 V	11.4 V
Battery weight (maximum)	0.19 kg	0.22 kg	0.19 kg	0.22 kg
Battery dimensions:				
	Height	5.73 mm	5.73 mm	5.73 mm
	Width	263 mm	263 mm	263 mm
	Depth	79.42 mm	79.42 mm	79.42 mm
Temperature range:				
	Operating	0°C to 45°C (32°F to 113°F)	0°C to 45°C (32°F to 113°F)	0°C to 45°C (32°F to 113°F)
	Storage	-20°C to 60°C (-4°F to 140°F)	-20°C to 60°C (-4°F to 140°F)	-20°C to 60°C (-4°F to 140°F)
Battery operating time	Varies depending on operating conditions and can significantly reduce under certain power-intensive conditions.	Varies depending on operating conditions and can significantly reduce under certain power-intensive conditions.	Varies depending on operating conditions and can significantly reduce under certain power-intensive conditions.	Varies depending on operating conditions and can significantly reduce under certain power-intensive conditions.
Battery charging time (approximate)	<ul style="list-style-type: none"> 0~15°C—4 hours (when the computer is off) 16~45°C—2 hours (when the computer is off) 46~50°C—3 hours (when the computer is off) 	<ul style="list-style-type: none"> 0~15°C—4 hours (when the computer is off) 16~45°C—2 hours (when the computer is off) 46~50°C—3 hours (when the computer is off) 	<ul style="list-style-type: none"> 0~15°C—4 hours (when the computer is off) 16~45°C—2 hours (when the computer is off) 46~50°C—3 hours (when the computer is off) 	<ul style="list-style-type: none"> 0~15°C—4 hours (when the computer is off) 16~45°C—2 hours (when the computer is off) 46~50°C—3 hours (when the computer is off)
 NOTE: Control the charging time, duration, start and end time, and so on using the Dell Power Manager application. For more information on the Dell Power Manager see, <i>Me and My Dell</i> on dell support .				
Coin-cell battery	CR2032	CR2032	CR2032	CR2032

Table 19. Battery specifications (continued)

Description	Option one	Option two	Option three	Option four
<p>CAUTION: Operating and storage temperature ranges may differ among components, so operating or storing the device outside these ranges may impact the performance of specific components.</p>				
<p>CAUTION: Dell recommends that you charge the battery regularly for optimal power consumption. If your battery charge is completely depleted, connect the power adapter, turn on your computer, and then restart your computer to reduce the power consumption.</p>				

Display

The following table lists the display specifications of your Latitude 3440.

Table 20. Display specifications

Description	Option one	Option two	Option three
Display type	14-inch, High Definition (HD)	14-inch, Full High Definition (FHD)	14-inch, Full High Definition (FHD)
Touch options	No	No	Yes
Color	262,144	262,144	16.2M
Panel type	6 bit	6 bit	6 bit+FRC
Display-panel technology	Twisted nematic	Wide Viewing Angle (WVA)/In Plane Switching (IPS)	Wide Viewing Angle (WVA)/In Plane Switching (IPS)
Display-panel dimensions (active area):			
	Height	309.37	309.37
	Width	174.02	174.02
	Diagonal	354.95	354.95
Display-panel native resolution	1366 x 768	1920 x 1080	1920 x 1080
Luminance (typical)	220 nits	250 nits	300 nits
Megapixels	1.05 megapixel	2.07 megapixel	2.07 megapixel
Color gamut	45% (NTSC)	45% (NTSC)	72% (NTSC)
Pixels Per Inch (PPI)	112	157	157
Contrast ratio (typical)	300:1	500:1	600:1
Response time (max)	25 ms	35	35 ms
Refresh rate	60 Hz	60 Hz	60 Hz
Horizontal view angle	45 +/- degrees	85 +/- degrees	85 +/- degrees
Vertical view angle	35 +/- degrees	85 +/- degrees	85 +/- degrees

Table 20. Display specifications (continued)

Description	Option one	Option two	Option three
Pixel pitch	0.2265 (H)*0.2265 (V)	0.161 (H)*0.161 (V)	0.161 (H)*0.161 (V)
Power consumption (maximum)	2.5 W	3.1 W	4.3 W
Anti-glare vs glossy finish	Anti-glare	Anti-glare	Anti-glare

Fingerprint reader

The following table lists the fingerprint-reader specifications of your Latitude 3440.

 **NOTE:** The fingerprint reader is on the power button.

Table 21. Fingerprint reader specifications

Description	Values
Fingerprint-reader sensor technology	Capacitive
Fingerprint-reader sensor resolution	500 ppi
Fingerprint-reader sensor pixel size	108 x 88

Sensor

The following table lists the sensor of your Latitude 3440.

Table 22. Sensor

Sensor support
Adaptive Thermal Performance-Applicable only for discrete graphics

GPU—Integrated

The following table lists the specifications of the integrated Graphics Processing Unit (GPU) supported by your Latitude 3440.

Table 23. GPU—Integrated

Controller	Memory size	Processor
Intel UHD Graphics	Shared system memory	12 th Generation Intel Core i3, Celeron
Intel Iris Xe Graphics	Shared system memory	13 th Generation Intel Core i3/i5/i7

GPU—Discrete

The following table lists the specifications of the discrete Graphics Processing Unit (GPU) supported by your Latitude 3440.

Table 24. GPU—Discrete

Controller	Memory size	Memory type
Nvidia GeForce MX550	2 GB	GDDR6

Multiple display support matrix

The following table lists the multiple display support matrix for your Latitude 3440.

Table 25. Multiple display support matrix

Graphics Card	Direct Graphics Controller Direct Output Mode	Supported external displays with computer internal display on	Supported external displays with computer internal display off
Intel UHD Graphics	Integrated	3	4
Intel Iris X ^e Graphics	Integrated	3	4
NVIDIA GeForce MX550	MS Hybrid	3	4

Hardware security

The following table lists the hardware security of your Latitude 3440.

Table 26. Hardware security

Hardware security
One wedge-shaped lock slot
TPM 2.0 discrete- Not supported for 12th Generation Intel® Celeron® 7305, 8 MB cache, 5 cores, 5 threads, up to 1.10 GHz
FIPS 140-2 certification for TPM
TCG Certification for TPM (Trusted Computing Group)
Chassis Intrusion Detection
BIOS - TPM clear and/or system boot lock after chassis intrusion detection
RPMC (specify via SPI Flash or eRPMC)
SPI Flash Tamper Detection / Prevention Shunt Circuit

Operating and storage environment

This table lists the operating and storage specifications of your Latitude 3440.

Airborne contaminant level: G1 as defined by ISA-S71.04-1985

Table 27. Computer environment

Description	Operating	Storage
Temperature range	0°C to 35°C (32°F to 95°F)	-40°C to 65°C (-40°F to 149°F)
Relative humidity (maximum)	90% (non-condensing)	95% (non-condensing)
Vibration (maximum)*	0.66 GRMS	NA
Shock (maximum)	140 G†	NA
Altitude range	-15.2 m to 3048 m (-49.8 ft to 10000 ft)	-15.2 m to 10668 m (-49.8 ft to 35000 ft)
 CAUTION: Operating and storage temperature ranges may differ among components, so operating or storing the device outside these ranges may impact the performance of specific components.		

* Measured using a random vibration spectrum that simulates the user environment.

† Measured using a 2 ms half-sine pulse.

Keyboard shortcuts of Latitude 3440

NOTE: Keyboard characters may differ depending on the keyboard language configuration. Keys used for shortcuts remain the same across all language configurations.

Some keys on your keyboard have two symbols on them. These keys can be used to type alternate characters or to perform secondary functions. The symbol shown on the lower part of the key refers to the character that is typed out when the key is pressed. If you press shift and the key, the symbol shown on the upper part of the key is typed out. For example, if you press **2**, **2** is typed out; if you press **Shift + 2**, **@** is typed out.

The keys F1-F12 at the top row of the keyboard are function keys for multi-media control, as indicated by the icon at the bottom of the key. Press the function key to invoke the task represented by the icon. For example, pressing F1 mutes the audio (refer to the table below).

However, if the function keys F1-F12 are needed for specific software applications, multi-media functionality can be disabled by pressing **Fn + Esc**. Subsequently, multi-media control can be invoked by pressing **Fn** and the respective function key. For example, mute audio by pressing **Fn + F1**.

NOTE: You can also define the primary behavior of the function keys (F1–F12) by changing **Function Key Behavior** in BIOS setup program.

Table 28. List of keyboard shortcuts

Function key	Primary behavior
F1	Mute audio
F2	Decrease volume
F3	Increase volume
F4	Mute mic
F5	Click keyboard backlight (optional). NOTE: Non-backlight keyboards have F5 function key without the backlight icon and do not support toggle keyboard backlight function. NOTE: Toggle to cycle the keyboard backlight status through off, low-backlight, and high-backlight
F6	Decrease brightness
F7	Increase brightness
F8	Switch to external display
F10	Print screen
F11	Home
F12	End

The **Fn** key is also used with selected keys on the keyboard to invoke other secondary functions.

Table 29. Secondary behavior

Function key	Secondary behavior
Fn + F1	Operating system and application specific F1 behavior
Fn + F2	Operating system and application specific F2 behavior
Fn + F3	Operating system and application specific F3 behavior
Fn + F4	Operating system and application specific F4 behavior

Table 29. Secondary behavior (continued)

Function key	Secondary behavior
Fn + F5	Operating system and application specific F5 behavior
Fn + F6	Operating system and application specific F6 behavior
Fn + F7	Operating system and application specific F7 behavior
Fn + F8	Operating system and application specific F8 behavior
Fn + F10	Operating system and application specific F10 behavior
Fn + F11	Operating system and application specific F11 behavior
Fn + F12	Operating system and application specific F12 behavior
Fn + PrtScr	Turn off/on wireless
Fn + B	Pause
Fn + Ctrl + B	Break
Fn + Insert	Sleep
Fn + S	Toggle scroll lock
Fn + H	Toggle between power and battery-status light/hard-drive activity light
Fn + R	System request
Fn + Ctrl	Open application menu
Fn + Esc	Toggle Fn-key lock
Fn + PgUp	Page up
Fn + PgDn	Page down
Fn + Home	Home
Fn + End	End
Fn + Right Ctrl	Shortcut/Secondary menu assigned to right Ctrl key
Fn + Shift + B	<p>Calls unobtrusive mode</p> <p>NOTE:</p> <p> The key sequence will call unobtrusive mode. The hotkey sequence will be disabled by default to prevent accidental actuation. You may enable through BIOS setup option.</p>

Getting help and contacting Dell

Self-help resources

You can get information and help on Dell products and services using these self-help resources:

Table 30. Self-help resources

Self-help resources	Resource location
Information about Dell products and services	Dell Site
Tips	
Contact Support	In Windows search, type <code>Contact Support</code> , and press Enter.
Online help for operating system	Windows Support Site Linux Support Site
Access top solutions, diagnostics, drivers and downloads, and learn more about your computer through videos, manuals, and documents.	Your Dell computer is uniquely identified using a Service Tag or Express Service Code. To view relevant support resources for your Dell computer, enter the Service Tag or Express Service Code at Dell Support Site . For more information about how to find the Service Tag for your computer, see Locate the Service Tag on your computer .
Dell knowledge base articles	<ol style="list-style-type: none"> 1. Go to Dell Support Site. 2. On the menu bar at the top of the Support page, select Support > Support Library. 3. In the Search field on the Support Library page, type the keyword, topic, or model number, and then click or tap the search icon to view the related articles.

Contacting Dell

To contact Dell for sales, technical support, or customer service issues, see [Dell Support Site](#).

 **NOTE:** Availability of the services may vary depending on the country or region, and product.

 **NOTE:** If you do not have an active Internet connection, you can find contact information about your purchase invoice, packing slip, bill, or Dell product catalog.